

2006 RIDGEBACK OWNER'S MANUAL

THANKS FROM BIG DOG MOTORCYCLES for your purchase. With that purchase comes a commitment to provide you support for your handcrafted motorcycle. This Owner's Manual has been prepared to acquaint you with the care and maintenance of your motorcycle while providing important safety information. Follow these instructions for maximum motorcycle performance, personal motorcycling safety and pleasure.

This manual is designed to go with the motorcycle, should you decide to sell it, in order to provide history and additional information to the next owner. The information in this manual is based on the most current production information available at the time of printing. Big Dog Motorcycles, L.L.C., reserves the right to make changes to their motorcycles without notice or obligation.



WARNING

THE FIRST 3,000 MILES ARE ESPECIALLY CRITICAL TO THE LONGEVITY AND PERFORMANCE OF YOUR BIG DOG MOTORCYCLE. MAKE SURE YOU FOLLOW THE NEW ENGINE BREAK-IN PROCEDURE OUTLINED ON PAGE 4 IN THIS MANUAL.

TABLE OF CONTENTS

| SECTION | PAGE |
|---|-----------|
| 1. GENERAL INFORMATION | 4 |
| Quick Start Guide Specifications Vehicle Identification Tires Cargo and Passenger Weight General Information | |
| 2. MAJOR COMPONENTS | 22 |
| Battery Controls Gear Shifter Power Train System Clutch Electrical System Ignition Switch Display Brake System Fuel System Fuel Valve | |
| 3. MAINTENANCE & STORAGE | 47 |
| Maintenance Maintenance Log Service Cleaning Storage Trouble-Shooting | |
| 4. WARRANTY | 77 |
| Warranty Warranty Transfer | |

HOW TO USE THIS MANUAL

Many people read their Owner's Manual from beginning to end when they first receive their new motorcycle. If you do, it will help you learn about the features and controls for the motorcycle. Every warning and caution has been carefully placed to keep you and those around you safe when operating the motorcycle.



WARNING

Emphasize areas or improper procedures that could result in mechanical damage or jeopardize your personal safety.



MAINTENANCE

Improve the longevity and performance of your motorcycle.



RIDING TIP

Useful in operating your motorcycle and enhance rider safety.

CONTACT US

PHONE US: 316-267-9121

EMAIL US: customerservice@bigdogmotorcycles.com

MAIL US: Big Dog Motorcycles, 1520 E. Douglas, Wichita, KS 67214

QUICK START GUIDE



WARNING

- PROLONGED IDLING WITH INADEQUATE AIRFLOW OVER THE ENGINE WILL CAUSE OVERHEATING AND PERMANENT DAMAGE TO THE ENGINE. HEAVY STOP AND GO TRAFFIC AND EXTENDED IDLING SHOULD BE AVOIDED ESPECIALLY DURING THE BREAK-IN PERIOD.
- IT IS THE OWNER'S RESPONSIBILITY NOT TO EXCEED THE MAXIMUM RPMs DURING THE BREAK-IN PERIOD. OVER-REVVING THE MOTORCYCLE CAN CAUSE PERMANENT DAMAGE TO THE ENGINE AND WILL VOID THE POWER TRAIN WARRANTY.

INITIAL BREAK-IN Internal engine component wear is critical in the first 3,000 miles. Observe break-in guidelines to assure future performance, durability and keep your warranty in force.

FIRST 3,000 MILES No higher than 4,000 RPM at any time in or out of gear. DO NOT lug the engine below 2,000 RPM in any gear. Follow the prescribed maintenance schedules. Avoid riding at a constant RPM for a prolonged period of time. Varying the RPM (between 2,000 and 4,000) will prolong the life of your new engine.

AFTER 3,000 MILES Follow the prescribed maintenance schedule located in Section 3 (Maintenance and Storage) in this manual.

QUICK START GUIDE

RPM TO MPH CONVERSION The below chart converts RPM to MPH. It is a guideline only. For more information contact a Big Dog Motorcycles Dealer or Authorized Service Center.

| | 2,000 RPM | 3,000 RPM |
|----------|-----------|-----------|
| 1ST GEAR | 19 MPH | 23 MPH |
| 2ND GEAR | 24 MPH | 33 MPH |
| 3RD GEAR | 33 MPH | 47 MPH |
| 4TH GEAR | 42 MPH | 56 MPH |
| 5TH GEAR | 53 MPH | 72 MPH |
| 6TH GEAR | 62 MPH | 81 MPH |

QUICK START GUIDE

COLD STARTING PROCEDURE This motorcycle comes equipped with electronic compression releases to aid in the starting of the engine.

- Make certain the motorcycle is in neutral.
- Turn fuel valve to the ON position.
- Turn ignition switch to the ON position.
- Depress handlebar ENGINE STOP switch to the RUN position. Note: The handlebar ENGINE STOP switch defaults to OFF every time the ignition switch is turned on.
- Prime the motor with two twists of the throttle.
- Lift up on carburetor enrichener half way.
- Depress start button for no more than five seconds at a time until the engine starts.
- Keep the engine running at fast idle or 1,500 RPM using the throttle.
- Depress the enrichener back to the pre-start position when the engine has achieved a constant and steady speed.
- If the enrichener is left in the starting position, the spark plugs will foul, causing poor engine performance and/or failed engine start.
- Allow engine to warm approximately one to two minutes before riding.

IMPORTANT: IF THE THROTTLE IS OPENED WHILE ENGAGING THE STARTER, COMPRESSION WILL INCREASE DRAMATICALLY CAUSING THE STARTER TO KICK BACK, POSSIBLY PRODUCING A STARTER FAILURE.

QUICK START GUIDE

NOTE: A BATTERY DISCHARGES UP TO 2% PER DAY WHEN IDLE. IF THE MOTORCYCLE IS NOT RIDDEN FOR A MONTH, THE BATTERY MAY NOT HAVE SUFFICIENT CHARGE TO START THE MOTORCYCLE. FOR THE OCCASIONAL RIDER, BIG DOG MOTORCYCLES RECOMMENDS USING A TRICKLE CHARGER (BDM250-00004). BIG DOG MOTORCYCLES DOES NOT RECOMMEND USING A STANDARD AUTOMOTIVE BATTERY CHARGER AS EARLY BATTERY FAILURE NOT COVERED UNDER WARRANTY MAY RESULT.

HOT ENGINE START Use the same procedure as cold start. Do not prime the engine with two (2) twists of the throttle and do not engage the carburetor enrichener.

QUICK START GUIDE

SHUTTING DOWN Use the ENGINE STOP SWITCH on the right handlebar to shut off the engine. Turn the ignition key switch to the "OFF" position. Turn the fuel valve to the "OFF" position.

SHIFTING INTO NEUTRAL This motorcycle is equipped with the Baker six-speed transmission with a positive neutral engagement. This will make shifting to neutral easier from first gear.

TURN SIGNALS The motorcycle's turn signal system is designed to self-cancel. While in neutral, or with either brake applied, depressing the appropriate signal switch will activate that signal continuously until the motorcycle is put in gear. Once in gear and brakes are released, the turn signal will cancel in 10 seconds. You can manually cancel the signal by pressing the same turn signal button. By applying both turn signal buttons at the same time, both signals will flash (hazard lights).

RIDING THE MOTORCYCLE After the engine has warmed up 1-2 minutes, the motorcycle is ready to ride. Coordination of the throttle and clutch lever assures a smooth positive forward movement of the motorcycle which is especially important during the break in period. Avoid over-revving the engine (especially when shifting). Do not attempt

QUICK START GUIDE

to “speed shift” or shift without using the clutch. Become acquainted with the brake and shifting characteristics of your new motorcycle at a low speed and in a familiar environment.

NOTE: BIG DOG MOTORCYCLES ARE EQUIPPED WITH A BAKER “SIX-SPEED DIRECT DRIVE” TRANSMISSION. WHEN SHIFTING GEARS EITHER UP OR DOWN, THE THROTTLE SHOULD BE CLOSED AND THE CLUTCH DISENGAGED. SPECIAL ATTENTION MUST BE GIVEN WHEN OPERATING IN FIRST AND SECOND GEAR, AS IT IS VERY EASY TO EXCEED ENGINE MAXIMUM RPM DURING ACCELERATION.

NOTE: DURING THE INITIAL BREAK IN PERIOD, THE MOTORCYCLE SHOULD NOT BE RUN FOR LONG PERIODS AT A CONSTANT RPM. VARYING THE RPM WILL HELP THE ENGINE DURING THIS CRUCIAL PERIOD AND PROLONG ENGINE LIFE.

This “QUICK START GUIDE” was designed to familiarize the owner with operating their new motorcycle. For any additional questions regarding the operation of the motorcycle, contact the nearest Big Dog Motorcycles Dealer or Authorized Service Center.

SPECIFICATIONS

| | | | |
|----------------------------|--------------------|-----------------------|------------------------|
| Dry Weight Front | 254 Lbs | Total Length | 108" |
| Dry Weight Rear | 400 Lbs | Front Brake | PM 4-Piston Diff. Bore |
| Dry Weight Total..... | 654 Lbs | Rear Brake | PM 4-Piston |
| GVWR | 1,085 Lbs | Front Tire | MH90-21 |
| GAWR Front | 390 Lbs | Rear Tire | 300/35-18 |
| GAWR Rear | 695 Lbs | Tire Pressure | F-40psi / R-42psi |
| Fuel Capacity - Total..... | 4.4 Gal | Engine | OHV 45 Degree V-Twin |
| Fuel Capacity - Main..... | 4.0 Gal | Displacement | 117 c.i. (1,916cc) |
| Fuel Capacity - Reserve | 0.4 Gal | Bore x Stroke | 4 1/8" x 4 3/8" |
| Oil Capacity..... | 3.5 Qts | Compression Ratio ... | 9.6:1 |
| Frame Specs | 4" OS BB, 8" OS DT | Transmission | Baker 6-Speed |
| Frame Rake | 39 Degrees | Primary Drive | Chain |
| Front Suspension | 41mm Telescopic | Final Drive | 1 1/8" Belt |
| Tube Length | 12" OS | Ignition..... | Electronic Single Fire |
| Seat Height | 24.25" | Charging Output | 40 Amp |
| Ground Clearance | 4" | Battery Type..... | Sealed |
| Wheel Base | 82" | Battery CCA | 270 |

VEHICLE IDENTIFICATION



VEHICLE ID NUMBER

The full 17-digit Vehicle Identification Number (VIN) is stamped on the steering head. Always give the full 17-digit number when ordering parts or making any inquiries about the motorcycle.

Example VIN:
5J11YBJ116W000004



ENGINE ID NUMBER

The engine identification number can be located on the upper left of the engine case.



TRANSMISSION ID NUMBER

The transmission identification number is found on the right underside of the case.

TIRES



WARNING

- REPLACE TIRES WITH BIG DOG MOTORCYCLES APPROVED TIRES ONLY. SERVICING TIRES AND WHEELS REQUIRES SPECIAL TOOLS AND SKILLS. WE RECOMMEND YOU SEE A BIG DOG MOTORCYCLES DEALER OR AUTHORIZED SERVICE CENTER FOR THESE SERVICES. TIRES, RIMS AND AIR VALVES MUST BE CORRECTLY MATCHED IN ORDER TO INSURE YOUR PERSONAL SAFETY. MISMATCHING TIRES, RIMS AND AIR VALVES MAY RESULT IN DAMAGE TO THE TIRE BEAD DURING MOUNTING OR MAY ALLOW THE TIRE TO SLIP ON THE RIM, POSSIBLY CAUSING TIRE FAILURE. IN ADDITION, USING TIRES OTHER THAN THOSE SPECIFIED MAY ADVERSELY AFFECT MOTORCYCLE STABILITY. TIRE SIZES ARE MOLDED ON THE TIRE SIDEWALL. IMPROPER TIRE INFLATION WILL CAUSE ABNORMAL TREAD WEAR AND COULD RESULT IN UNSTABLE HANDLING. UNDER-INFLATION COULD RESULT IN THE TIRE SLIPPING ON THE RIM OR SUDDEN TIRE FAILURE. INSPECT TIRE TREAD FOR PUNCTURES, CUTS, BREAKS, ETC., AT LEAST WEEKLY (IF IN DAILY USE) OR BEFORE EACH TRIP (IF USED ONLY OCCASIONALLY).
- IF THERE IS UNCERTAINTY WITH THE TIRE INTEGRITY, HAVE A BIG DOG MOTORCYCLES DEALER OR AUTHORIZED SERVICE CENTER REMOVE AND CAREFULLY INSPECT THE INSIDE AS WELL AS THE OUTSIDE OF THE TIRE. A DAMAGED TIRE CAN FAIL CAUSING PERSONAL INJURY. RIDING WITH EXCESSIVELY WORN, UNBALANCED OR IMPROPERLY INFLATED TIRES IS HAZARDOUS AND WILL ADVERSELY AFFECT TRACTION, STEERING AND HANDLING.

TIRES

CUTS AND ABRASIONS A part of your pre-ride inspection should be to inspect the tires each time before you ride. You should look for cuts, abrasions or abnormalities. Cuts on the tire, nails or glass fragments embedded in the tire can all be very dangerous. If you find these conditions, you should have the tire replaced.

TIRE INTEGRITY Maintaining tire integrity cannot be stressed enough. Because the traction of your motorcycle is directly related to the condition of the tires, make every effort to ensure the integrity of the tires each time you ride. Be sure to keep tires properly inflated. See the information on air pressure in this section for correct cold tire pressure. Maximum inflation pressure must not exceed specifications on tire sidewalls.

AIR PRESSURE RECOMMENDATIONS

REAR: 42 PSI

FRONT: 40 PSI

CARGO AND PASSENGER WEIGHT

WARNING

KEEP CARGO WEIGHT CONCENTRATED CLOSE TO THE MOTORCYCLE AND AS LOW AS POSSIBLE TO MINIMIZE ANY CHANGE TO CENTER OF GRAVITY (BALANCE POINT). DISTRIBUTE WEIGHT EVENLY ON BOTH SIDES OF THE MOTORCYCLE AND DO NOT LOAD BULKY ITEMS OR ADD WEIGHT TO THE HANDLEBARS OR FRONT FORKS. DO NOT EXCEED 15 POUNDS MAXIMUM LOAD IN EACH SADDLEBAG. IMPROPER LOADING CAN CAUSE VEHICLE HANDLING PROBLEMS AND RESULT IN PERSONAL INJURY.

CARRYING TRAVEL GEAR Overloading, particularly at the rear of a motorcycle, can cause instability. Carefully check any approved accessories for the maximum weight capacities. Luggage racks are designed for light weight items only. Do not overload racks. Be sure cargo is secure and will not shift while riding. Recheck load periodically.

The addition of accessories and additional weight to the motorcycle can affect the stability, handling characteristics and safe operating speed. Because Big Dog Motorcycles cannot test and make specific recommendations concerning every accessory or combination of accessories, riders must be responsible for safe operation of the motorcycle when operating with accessories or carrying additional weight.

The following guidelines should be used when equipping your motorcycle with accessories or carrying a passenger and cargo:

CARGO AND PASSENGER WEIGHT

1. Our motorcycles are carefully engineered to be ridden in their original configuration or only with authorized Big Dog Motorcycles accessories.
2. Unauthorized accessories that change the operator's riding position may reduce reaction time and alter handling characteristics.
3. Overloading the motorcycle by exceeding Gross Vehicle Weight Rating (GVWR) may alter handling characteristics and reduce braking efficiency.
4. Do not attempt "custom" alterations such as extended forks or frame modifications.
5. Never attach or attempt using a sidecar.
6. Do not tow a trailer with your motorcycle under any circumstance.
7. Modifications and/or additional electrical equipment are not recommended. Any alterations of the 2006 electrical system (turn signals, additional lighting, etc.) could cause an overloading of printed circuits.

CARRYING A PASSENGER When carrying a passenger, it is your responsibility to instruct them on proper riding procedures as well as the proper clothing to wear. Do not attempt to carry more than one passenger at a time.

WARNING

PILLION PADS CANNOT BE USED ON MOTORCYCLES WITH FLAT MATTE FINISH PAINT JOBS DUE TO INADEQUATE SUCTION TO THE REAR FENDER. INSTALLING A PILLION PAD ON THIS PARTICULAR PAINT FINISH COULD RESULT IN THE PILLION PAD SLIDING OFF THE REAR FENDER RESULTING IN INJURY TO THE PASSENGER.

GENERAL INFORMATION

WARNING

- SHOULD ANY ABNORMALITY OCCUR IN THE OPERATION OF YOUR MOTORCYCLE, IMMEDIATELY CONTACT A BIG DOG MOTORCYCLES DEALER OR SERVICE CENTER FOR CORRECTION OF THE PROBLEM.
- BE SURE ALL EQUIPMENT REQUIRED BY FEDERAL, STATE AND LOCAL LAW IS INSTALLED AND IN GOOD OPERATING CONDITION. REGULARLY INSPECT SHOCK ABSORBERS AND FRONT FORKS, CHECKING FOR LEAKS. WORN PARTS CAN AFFECT STABILITY.
- USE ONLY AUTHORIZED REPLACEMENT FASTENERS TIGHTENED TO THE PROPER TORQUE. SUBSTITUTION COULD CAUSE FASTENER FAILURE.

FUELING Use only unleaded gasoline. Ethanol blended gasoline is approved as long as it has 87 octane minimum. Methanol or methanol blended fuel is NOT approved for use in your motorcycle.

Do not use decorative type fuel cap covers, which may possibly cause the caps to loosen from the tank upon impact. Our motorcycles do not come equipped with a fuel gauge. It is advisable to always reset the trip odometer to "0" after refueling and get to know the range of the motorcycle.

GENERAL INFORMATION

HEAT The engine, drive train, exhaust pipes and muffler on the motorcycle become very hot when the engine is running and remain too hot to touch for some time after the engine is turned off. Make sure that you, as well as any passenger you carry, wear clothing that will completely cover legs when riding. Avoid contact with the exhaust system.

EXHAUST HAZARDS Motorcycle exhaust contains carbon monoxide gas. Do not inhale exhaust fumes and NEVER run the engine in a closed space like a closed garage or indoors.

SECURITY In order to protect the motorcycle against theft, lock the ignition and remove the key from the switch when leaving the motorcycle unattended.

TOWING Do not tow a disabled motorcycle with another vehicle. If a disabled motorcycle must be transported, load into a truck or trailer for transportation.

LOANING TO OTHERS Do not allow others to operate your motorcycle unless you are certain they are experienced, licensed riders and are familiar with the operation of your particular motorcycle.

GENERAL INFORMATION

ROAD CONDITIONS Pay strict attention to your surroundings. Avoid riding when the weather is a serious factor such as high wind, heavy fog, rain, snow, ice or other factors that would make the ride less safe. Know your limitations and do not ride when the weather is beyond your skills or comfort zone. The first 15 minutes of a rainstorm brings all oil and contaminants to the road surface causing a slippery condition.

PARKING To park, come to a complete stop, put the transmission in neutral, shut the engine off, turn off ignition, remove key, turn fuel off and use the side stand to support the motorcycle. Park on solid, level ground. If parking on a slope is unavoidable, face the motorcycle uphill. Failure to face the motorcycle uphill while parked could cause the motorcycle to tip over. Parking on asphalt during an extremely hot day is not advised. The asphalt may compress under the load from the side stand allowing the motorcycle to tip over.

 **WARNING**

MAKE SURE SIDE STAND IS FULLY RETRACTED BEFORE RIDING. IF THE SIDE STAND IS NOT FULLY RETRACTED, IT COULD CONTACT THE ROAD SURFACE CAUSING LOSS OF CONTROL OF THE MOTORCYCLE.

GENERAL INFORMATION

GOOD JUDGMENT Safe motorcycle operation requires mental awareness and good judgment, combined with a defensive driving attitude.

SAFE SPEED Operate your motorcycle only at moderate speed in and out of traffic until you have become thoroughly familiar with its operation and handling characteristics under all conditions. If you are an inexperienced rider, we recommend that you take a certified course on motorcycle riding.



RIDING TIP

MAKE SURE YOU ARE WEARING A D.O.T. APPROVED HELMET, EYE PROTECTION, CLOTHING AND FOOTGEAR SUITED FOR MOTORCYCLE RIDING. BRIGHT OR LIGHT COLORS ARE BEST FOR VISIBILITY IN TRAFFIC, ESPECIALLY WHEN DRIVING AT NIGHT OR IN LOW LIGHT CONDITIONS. AVOID CLOTHING THAT MAY GET TANGLED IN ANY PART OF THE MOTORCYCLE. NEVER WEAR DARK GLASSES AT NIGHT OR IN LOW LIGHT SITUATIONS. SHORTS AND SANDALS ARE NOT A GOOD CHOICE WHILE RIDING A MOTORCYCLE AT HIGHWAY SPEEDS. NEVER RIDE UNDER THE INFLUENCE OF DRUGS OR ALCOHOL.

GENERAL INFORMATION

FRAME CONSTRUCTION The frame is made from high-strength seamless steel tubing and utilizes a high tensile strength welding process held to extremely tight tolerances.

Any attempt to modify the frame of the motorcycle is extremely dangerous and will void the manufacturer's warranty. Altering the frame in any way takes the motorcycle out of its original configuration and may expose it to stresses that it was never intended to withstand.

FRONT SUSPENSION This motorcycle uses conventional telescopic front fork assemblies.

The front suspension is vital to the motorcycle's handling. Broken or worn parts need immediate attention. Do not attempt to service the suspension. Please contact a Big Dog Motorcycles Dealer or Authorized Service Center for any problems with these components.

REAR SUSPENSION This motorcycle has an adjustable rear suspension. It is important to pay close attention to the way the motorcycle handles and if there is a change in handling you should immediately have the problem diagnosed by a Big Dog Motorcycles Dealer or Authorized Service Center.

GENERAL INFORMATION

Riding your motorcycle can be an enormous source of enjoyment. However, there are risks associated with riding any motorcycle. To minimize these risks, you should:

1. Review and follow the operating and maintenance instructions in this manual.
2. Take notice of every warning in this manual.
3. Recognize and respect the "rules of the road." To ensure your personal safety, obtain a copy of your state's "Motorcycle Handbook" and understand the contents.
4. Enroll in a Certified Rider Training Course approved by the Motorcycle Safety Foundation (MSF). New riders as well as experienced riders will benefit from successfully completing a riding course. In many states, completing a riding course could lower your insurance premium. For more information about a MSF training course near you, call the national toll-free number: (800)446-9227 (USA only).
5. Be sure to keep your motorcycle in proper operating condition in accordance with the maintenance intervals chart in this owner's manual. Particularly important to motorcycle stability is proper tire pressure, tread condition and sound condition of wheel bearings and steering head bearings.
6. Do not operate a motorcycle with a loose, worn or damaged steering or suspension system.



SECTION 2

MAJOR COMPONENTS

Battery | Controls | Gear Shifter | Power Train System | Clutch | Electrical System | Ignition Switch | Display | Brake System | Fuel System | Fuel Valve

BATTERY

BATTERY The battery and electrical components are located under the seat. This motorcycle has a maintenance-free battery. Any attempt to open the battery is extremely dangerous and will void the warranty. You cannot check the battery electrolyte level or add distilled water as you would with a conventional type battery. If the battery seems weak, causing slow starting or other electrical problems contact a Big Dog Motorcycles Dealer or Authorized Service Center.

If you do not ride frequently, Big Dog Motorcycles recommends using a Trickle Charger (BDM250-00004).

SEAT REMOVAL To remove the seat, place fingers under the seat or pillion pad and locate the suction release tab. Release the suction cups by pulling up on the suction release tabs. Remove seat carefully to avoid damage to painted surfaces. Failure to use the suction release tabs prior to seat removal may cause the suction cups to separate from the seat.



WARNING

BATTERY POSTS AND TERMINALS CONTAIN LEAD AND LEAD COMPOUNDS. WASH YOUR HANDS THOROUGHLY AFTER HANDLING.

CONTROLS

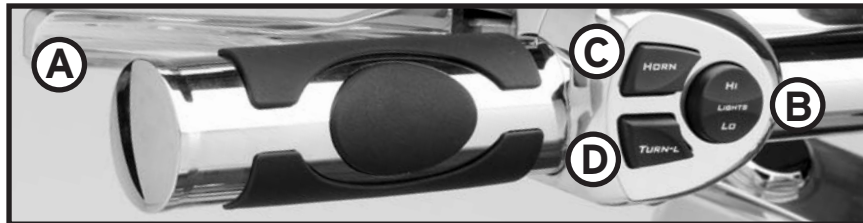

- A. CLUTCH HAND LEVER** The clutch hand lever is operated with the left hand. Pull the lever against the handlebar grip to disengage clutch; release the lever smoothly outward to engage clutch.
- B. HEAD LAMP HIGH/LOW SWITCH** The head lamp switch controls the head lamp high and low beams.
- C. HORN SWITCH** The horn is operated by depressing the horn switch.
- D. LEFT TURN SIGNAL** The left turn signal is operated by the TURN-L switch.



WARNING

KEEP YOUR FINGERS FROM BETWEEN HAND CONTROL LEVERS AND HANDLEBAR GRIPS OR YOU WILL BLOCK FULL USE OF THE CONTROLS.

CONTROLS

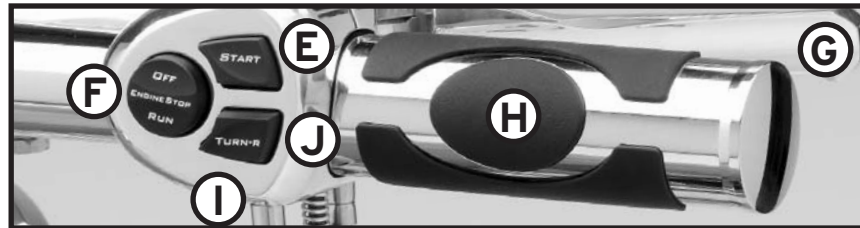

- E. ELECTRIC STARTER SWITCH** After the ignition key is turned to the ON position, press RUN on the ENGINE STOP SWITCH before pressing the START SWITCH.
- F. ENGINE STOP SWITCH** The engine stop switch turns the ignition on or off and should be used every time to stop the engine.
- G. FRONT BRAKE HAND LEVER** The front brake hand lever is operated with the right hand. Pull the lever in towards the handlebar grip to engage the front brake.
- H. THROTTLE CONTROL GRIP** Turn the control grip counter clockwise to open the throttle and clockwise to close it.
- I. THROTTLE FRICTION ADJUSTING SCREW** Located at the bottom of the throttle grip clamp. When used properly, it can help reduce rider fatigue. Do not use the throttle friction adjusting screw when in town or heavy traffic.
- J. RIGHT TURN SIGNAL** The right turn signal is operated by the TURN-R switch.

GEAR SHIFTER

WARNING

- DO NOT FORCE THE TRANSMISSION TO SHIFT UNDER ANY CIRCUMSTANCES. FORCING A SHIFT MAY DAMAGE THE SHIFT LEVER OR THE PRIMARY DRIVE TRAIN.
- DO NOT RIDE WITH YOUR FOOT ON THE GEAR SHIFTER.
- WHEN UP-SHIFTING OR DOWNSHIFTING, THE THROTTLE SHOULD BE CLOSED AND THE CLUTCH FULLY DISENGAGED.



GEAR SHIFTER

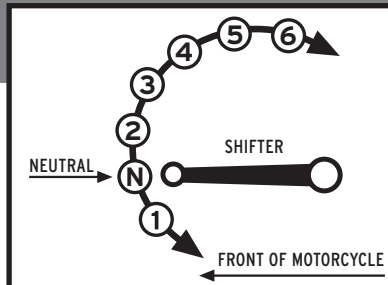

GEAR SHIFTER

The gear shifter is located on the left forward foot control. There are six forward gears and no reverse. Pushing the lever down shifts the transmission into the next lower gear, lifting the shift lever up shifts the transmission into the next higher gear.

This motorcycle comes equipped with a Baker six-speed transmission. The top three gears are "helical cut" to reduce noise, improve gear engagement and ease shifting effort. The operator must release the gearshift lever after each gear change and allow the lever to return to its central position before another gear change can be made.

The neutral position is between first and second gear. To shift into neutral from first gear raise the shift lever slightly until you feel a slight "click". If the key is on, the green neutral indicator light will stay on after you release the pressure on the shift lever if you are in neutral. To shift to neutral from second gear, reverse the procedure. If the motorcycle is not running, it may be necessary to rock the motorcycle backward or forward slightly with the clutch lever pulled in while maintaining steady pressure on the shift lever to shift into neutral.

POWER TRAIN SYSTEM

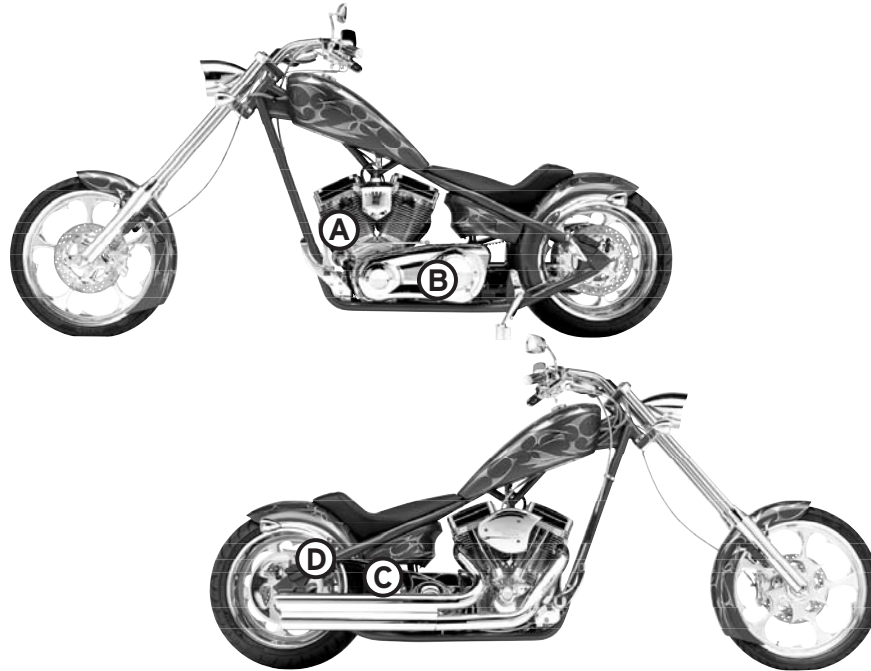

POWER TRAIN SYSTEM

SYSTEM COMPONENTS The power train of this motorcycle is composed of:

A. V-TWIN, 117 CUBIC-INCH, FOUR-STROKE ENGINE

B. CHAIN DRIVEN PRIMARY DRIVE The primary drive delivers power from the engine to the transmission. The primary drive of this motorcycle is composed of a double row drive chain running from the crankshaft sprocket inside the primary drive case to the clutch.

C. BAKER 6-SPEED TRANSMISSION The transmission delivers the power it receives from the engine to the rear wheel via the final drive belt. The transmission also allows the engine to operate within its limitations under varying speeds and conditions. Proper gear selection while riding will enhance your enjoyment, safety and help to ensure longevity of the engine.

D. RIGHT SIDE BELT DRIVEN FINAL DRIVE The final drive is the last link in the power train and connects the transmission to the rear wheel. This motorcycle utilizes a durable synthetic belt for the final drive which gives a quieter, smoother ride.

CLUTCH

MANUAL, MULTI-PLATE CLUTCH The purpose of the clutch is to engage and disengage the flow of power from the engine to the transmission. A multi-plate clutch assembly is attached to the transmission input shaft. The transmission drive sprocket is attached to this clutch basket and is driven by the engine via a double row primary chain. A starter ring gear, also attached to this clutch assembly, engages with the starter motor's pinion gear to start the engine. The clutch is manually operated through a lever mounted on the left side handlebar.

The life of the clutch can be greatly prolonged by following these simple guidelines:

1. Resist the urge to "ride" the clutch (holding the clutch lever partially compressed).
2. When shifting gears, make sure the throttle is closed before you engage or disengage the clutch.
3. Keep your fingers from between the clutch hand lever and the handlebar grip when compressing so the clutch can fully disengage.
4. From a dead stop or at slow speeds in low gears, the clutch should be engaged slowly yet deliberately. At higher speeds and in higher gears, engage and disengage the clutch with a swift and deliberate action.

CLUTCH

CLUTCH ADJUSTMENTS Maintaining the proper tension on the clutch cable is critical to the longevity of the motorcycle's clutch.

If the clutch cable is too tight, the clutch plates will not fully engage. This causes the clutch to slip. If the clutch cable has too much slack, the clutch will not completely release. This may cause hard shifting, vehicle creep, overheating and warping of the clutch plates and may make finding neutral difficult.



WARNING

AN IMPROPERLY ADJUSTED CLUTCH CABLE CAN CAUSE CLUTCH PLATES, CLUTCH PUSH RODS AND CLUTCH THROW-OUT-BEARINGS TO OVERHEAT AND/OR WARP. CLUTCH REPAIRS AND ADJUSTMENTS ARE A SERIOUS MATTER AND SHOULD ONLY BE PERFORMED BY A BIG DOG MOTORCYCLES DEALER OR AUTHORIZED SERVICE CENTER.

ELECTRICAL SYSTEM

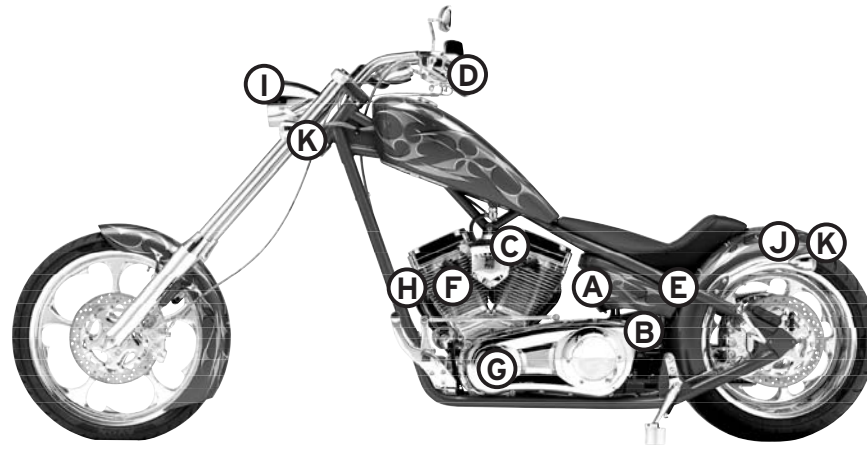

ELECTRICAL SYSTEM

The electrical system supplies electrical power to all the various components of the motorcycle. The electrical system of this motorcycle can be broken down into four major systems and are composed of the following:

1. **STARTING**
A. BATTERY; B. STARTING MOTOR
2. **CHARGING**
C. IGNITION SYSTEM; D. ENGINE OFF/RUN SWITCH; E. ELECTRONIC HARNESS; F. SPARK PLUGS
3. **IGNITION**
G. ALTERNATOR; H. VOLTAGE REGULATOR
4. **LIGHTING**
I. HEADLIGHT; J. TAIL LIGHT; K. TURN SIGNALS

WARNING

ADJUSTING THE IGNITION TIMING ON THE RIDGEBACK IS NOT POSSIBLE. TIMING IS DETERMINED BY THE CRANK SENSOR AND THE IGNITION MODULE CALIBRATES THE FIRING SEQUENCE. DO NOT ATTEMPT TO REPROGRAM OR ADJUST THE IGNITION MODULE.

ELECTRICAL SYSTEM

2006 ELECTRONIC DEVICES AND THEIR DEFAULTS Incorporated in the 2006 electrical system are:

1. Electronic controlled compression releases.
2. Self-canceling turn signals after a 10-second interval.
3. Self-diagnosing EHC (Electronic Harness Control).
4. LED tail light, turn signals, tag light and front and rear running lights.
5. Ignition switch off, returns the headlight to low beam for the next time ignition switch is turned on.
6. Ignition switch off, returns the run/stop switch on the right handlebar to the stop position.
7. Hazard lights are activated by applying both turn signal switches simultaneously and can be deactivated by applying either turn signal.
8. With the engine not running, the hazard lights can be activated by applying both turn signals but the head light defaults to the off position to conserve battery power. The headlight will remain in the off position until the run/start button is engaged or the hazard lights are deactivated.

ELECTRICAL SYSTEM

If your motorcycle exhibits any of the following symptoms the ignition system may need diagnostic analysis by a Big Dog Motorcycles Dealer or Authorized Service Center:

1. Engine does not start or difficulty in starting.
2. Starter kickback.
3. Poor running at low speeds.
4. Poor running or low power at high speeds.
5. Knocking or abnormal engine noise.

For any electrical problems, it is best to take your motorcycle to a Big Dog Motorcycles Dealer or Authorized Service Center. They have the parts, equipment and training to diagnose the problem and make the necessary repairs.

IGNITION SWITCH

The ignition switch activates the EHC which controls the electrical functions of the motorcycle.



SWITCH POSITIONS There are only two ignition key positions. Vertical, or up, is ignition OFF and the key is removable in this position. Horizontal, or sideways, is ignition ON and the key should not be able to be removed. In the horizontal or "ON" position, the following will occur:

- A. Speedo self-test display mode: one to three seconds - calibrated pulse count; four to six seconds - elapse time/accumulated time; seven seconds - odometer/trip mode.
- B. Power up: headlight - defaults to low beam; annunciator lights; tail, tag and running lights - front and rear.

IGNITION SWITCH

After shutting down the engine, always turn the switch to the OFF position. If you leave the ignition ON, the lights will run down the battery. To prevent theft, always lock the ignition and remove the key when the motorcycle is left unattended.

WARNING

- DO NOT ATTACH LARGE, HEAVY KEY RINGS OR OTHER OBJECTS TO THE IGNITION KEY AS THIS CAN DAMAGE THE COIL COVER AND THE IGNITION SWITCH.
- IF THE IGNITION IS TURNED ON IMMEDIATELY AFTER THE ENGINE IS STOPPED, THE OIL PRESSURE LIGHT MAY NOT COME BACK ON IMMEDIATELY DUE TO RETAINED OIL PRESSURE.
- DO NOT MODIFY THE LIGHT SWITCH WIRING TO CIRCUMVENT THE AUTOMATIC-ON HEADLIGHT FEATURE. HIGH VISIBILITY IS AN IMPORTANT SAFETY CONSIDERATION FOR MOTORCYCLE RIDERS.

DISPLAY



WARNING

NEVER ATTEMPT TO TAMPER WITH OR ALTER THE VEHICLE ODOMETER. THIS IS ILLEGAL.



A. LEFT TURN INDICATOR LIGHT The yellow turn indicator will flash when the left turn indicator is activated.

B. OIL INDICATOR LIGHT The red oil pressure indicator light signals low oil pressure when lit. This light will come on when the ignition is on, and off when minimum engine oil pressure is reached.

C. TRANSMISSION NEUTRAL LIGHT The green indicator will help you find neutral as you become familiar with shifting .

D. HIGH BEAM LIGHT The blue indicator light is lit when the headlight is switched to the "High" position.

E. RIGHT TURN INDICATOR LIGHT The yellow turn indicator will flash when the right turn indicator is activated.

DISPLAY

F. SPEEDOMETER/ODOMETER The speedometer registers speed in statute miles per hour. The odometer registers the total number of statute miles the vehicle has traveled. The trip odometer registers the total statute miles the motorcycle traveled since it was last reset. To reset the trip odometer, depress and hold the black button under the odometer when the total miles ridden are displayed. This will zero out and reset the trip odometer.

G. TACHOMETER The Tachometer registers in 500 RPM (Revolutions Per Minute) increments. If the engine falls below 900-RPM, all LED's will flash warning the rider of engine lugging. At 4,500-RPM the Yellow LED's will illuminate and at 6,000-RPM the Red LED's will illuminate as rev limiting engages.



WARNING

IF THE OIL PRESSURE INDICATOR LIGHT FAILS TO GO OFF WITHIN THREE TO FIVE SECONDS AFTER STARTING, IMMEDIATELY SHUT THE ENGINE OFF. CHECK THE OIL SUPPLY. IF OIL SUPPLY IS NORMAL AND AFTER RESTARTING THE ENGINE THE LIGHT STILL DOES NOT GO OFF. SHUT OFF THE ENGINE AT ONCE AND DO NOT ATTEMPT TO RUN UNTIL THE TROUBLE IS LOCATED AND THE NECESSARY REPAIRS ARE MADE.

BRAKE SYSTEM

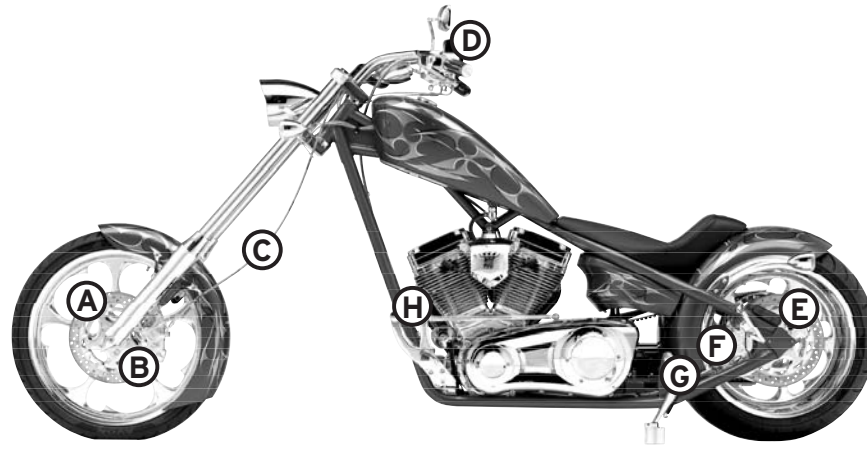

BRAKE SYSTEM

FRONT BRAKE COMPONENTS The front brake is a hydraulic disc type, which is operated by the hand lever on the right handle bar. It is composed of:

- A. FRONT DISC ROTOR
- B. FOUR-PISTON CALIPER
- C. BRAIDED STAINLESS STEEL LINE
- D. 5/8" BORE MASTER CYLINDER & RESERVOIR

REAR BRAKE COMPONENTS The rear brake is a hydraulic disc type, which is operated by the pedal on the right foot rest. It is composed of:

- E. REAR DISC ROTOR
- F. FOUR-PISTON CALIPER
- G. BRAIDED STAINLESS STEEL LINE
- H. 5/8" BORE MASTER CYLINDER & RESERVOIR

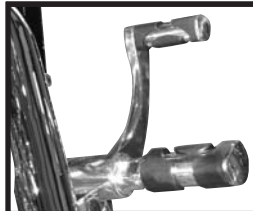

NOTE: THE REAR BRAKE PEDAL IS LOCATED ON THE RIGHT FORWARD FOOT CONTROL. DO NOT RIDE WITH YOUR FOOT RESTING ON THE BRAKE PEDAL. THIS WILL CAUSE PREMATURE WEAR OF THE BRAKE PADS AND CAN REDUCE YOUR BRAKING ABILITY.

BRAKE SYSTEM

FOR NORMAL BRAKING Apply both front and rear brakes. The brake system supplies best stopping when applied simultaneously. Pull in the clutch lever to prevent the engine from stalling. **ONLY APPLYING THE REAR BRAKE CAN REDUCE YOUR BRAKING ABILITY BY UP TO 70%.**



WARNING

HARD BRAKING MAY CAUSE WHEEL LOCK AND CAN RESULT IN LOSS OF CONTROL OF THE MOTORCYCLE. THINGS SUCH AS WATER, OIL OR DEBRIS ON THE ROAD SURFACE CAN ADVERSELY AFFECT YOUR BRAKING ABILITY AND MAY CAUSE LOSS OF CONTROL UNDER EXTREME BRAKING. ALWAYS LEAVE YOURSELF ENOUGH ROOM TO STOP WITHOUT LOSS OF CONTROL.

MAINTAINING BRAKE SYSTEM INTEGRITY Keeping the braking system performance at its best requires both master cylinder fluid reservoirs to be kept full of DOT 5 brake fluid. Having adequate wear surface on the brake pads is equally important. Remember, brake fluid level will drop slightly as the brake pads wear. Low brake fluid level may allow air to enter the brake system causing it to feel “spongy” and become ineffective. Inspect brake fluid level and brake pads for wear on a regular basis. Both front and rear master cylinders should be filled to, but not above reservoir undercut.

BRAKE SYSTEM

WARNING

- "RIDING" THE BRAKES CAN CAUSE OVERHEATING, REDUCING THEIR EFFECTIVENESS. NEVER RIDE WITH YOUR FOOT RESTING ON THE BRAKE PEDAL OR YOUR HAND PUTTING PRESSURE ON THE FRONT BRAKE LEVER EXCEPT WHEN STOPPING.
- AVOID PROLONGED BRAKE APPLICATION. THIS CAN OVERHEAT THE BRAKES AND REDUCE THEIR EFFECTIVENESS.

If you experience trouble with the brake system, have it inspected by a Big Dog Motorcycles Dealer or Authorized Service Center. You can also refer to the Troubleshooting section for help.

FUEL SYSTEM

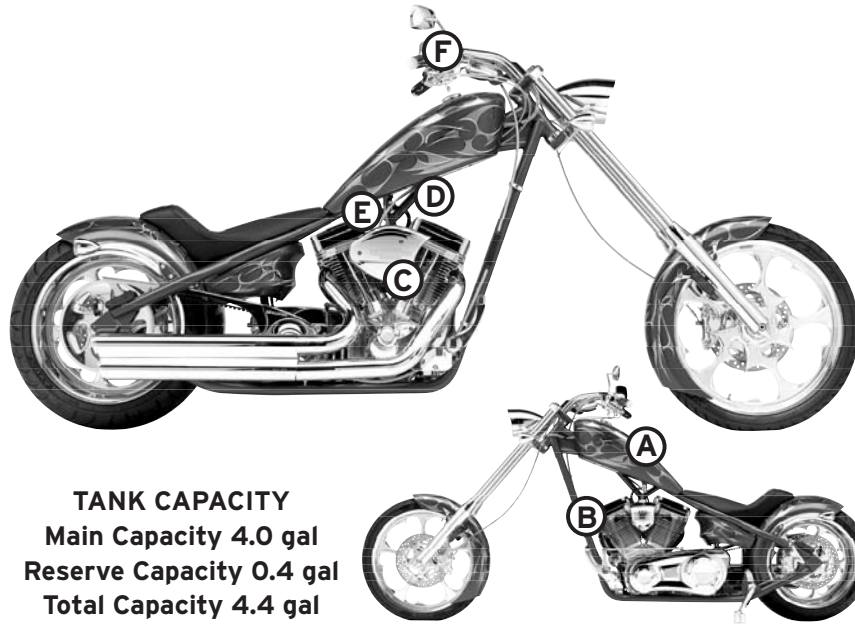

TANK CAPACITY
Main Capacity 4.0 gal
Reserve Capacity 0.4 gal
Total Capacity 4.4 gal

FUEL SYSTEM

The fuel system of this motorcycle is composed of:

- A. FUEL TANK** One-piece tank design incorporating gas-cap vents. To open the gas cap turn counterclockwise.
- B. FUEL VALVE** (See illustration on next page)
- C. CARBURETOR** The carburetor is the central part as well as the most complex part of the fuel system. For information on maintenance of the air filter see Section 3.
- D. FUEL LINE**
- E. ENRICHENER** Facilitates cold starting by creating a richer than normal fuel condition. The enrichener lever is positioned on the top of the carburetor behind the air filter housing. Lift up the enrichener lever for cold starting. Push down the enrichener lever to close as the engine begins to warm.
- F. THROTTLE GRIP AND CABLES** The throttle grip and cables are connected to the throttle plate inside the carburetor. Check the cables for breaks, kinks or other visible damage and ease of opening and closing of the throttle prior to riding each time.

FUEL VALVE



IN THE FUEL ON POSITION, FUEL ENTERS THE VALVE FROM APPROXIMATELY ONE INCH ABOVE THE BOTTOM OF THE TANK. THE RESERVE POSITION ALLOWS THE FUEL THAT IS LEFT IN THE BOTTOM OF THE TANK TO ENTER THE VALVE IF YOU USE THE FUEL RESERVE, REMEMBER TO TURN THE VALVE FROM THE RESERVE TO THE ON POSITION AFTER REFUELING.

FUEL VALVE This motorcycle comes equipped with a high performance, high flow fuel valve. The fuel valve is located under the fuel tank on the left side of the motorcycle. The valve position is marked on the base of the fuel valve just above the lever. Always close the fuel valve when the engine is not running. Failure to do so can result in flooding the engine with fuel, making the motorcycle difficult to start.

FUEL ON Turn the lever until it has stopped in the ON position.

FUEL OFF Turn the lever until it has stopped in the OFF position.

FUEL RESERVE Turn the lever until it is centered between the ON and OFF positions.



SECTION 3

MAINTENANCE & STORAGE

Maintenance | Maintenance Log | Service | Cleaning | Storage | Trouble-Shooting

MAINTENANCE

To achieve the greatest safety, reliability and performance from this motorcycle regular maintenance procedures must be followed. These include inspection, lubrication and adjustment. A Big Dog Motorcycles Dealer or Authorized Service Center will service your motorcycle, using factory approved methods, equipment and products, assuring you competent service.



WARNING

MAINTENANCE AT REGULAR INTERVALS IS REQUIRED TO KEEP YOUR NEW MOTORCYCLE'S WARRANTY IN EFFECT. IF YOU OR SOMEONE OTHER THAN A BIG DOG MOTORCYCLES DEALER OR AUTHORIZED SERVICE CENTER PERFORMS THE REQUIRED SERVICE, YOU MUST CONTINUOUSLY MAINTAIN AND RETAIN RECEIPTS, LOGS, AND OTHER DOCUMENTATION SUFFICIENT TO PROVE THAT THE REQUIRED MAINTENANCE WAS PERFORMED AT THE PROPER INTERVAL ACCORDING TO THE MAINTAINENCE LOG LOCATED IN THIS SECTION.

Prior to delivery of this new motorcycle, a technician at the dealership where the motorcycle was sold performed a PDI (Pre-Delivery Inspection). This inspection was conducted to ensure that all components are adjusted correctly and in proper working order, and that all fluids are at the proper level.

MAINTENANCE

GENERAL INSPECTION Good maintenance means a safe machine. A careful check of certain equipment must be made after periods of storage and frequently between the regular service intervals to determine if additional maintenance is necessary. The following items should be checked regularly:

1. Tires - for correct pressure, abrasions or cuts.
2. Brakes, steering and throttle - for responsiveness.
3. Drive belt - for condition.
4. Brake fluid - for level and condition.
5. Brake lines and fittings - for leaks.
6. Brake pads and discs - for excessive or disproportionate wear.
7. Cables - for fraying or crimping and free operation.
8. Engine oil, primary chaincase and transmission fluid - to maintain proper levels.
9. Headlamp, tail lamp, brake lamp and directional lamps - for proper operation.

To ensure the quality, safety and reliability of any repair, use only genuine Big Dog Motorcycles parts or recommended equivalents for replacement.

MAINTENANCE

By using the following recommended maintenance schedule, you will be assured longevity, reliability and performance of your motorcycle.

The mileage intervals shown in the maintenance schedule are intended as a guide for regular maintenance and lubrication periods for this motorcycle. With sustained adverse conditions (temperature extremes, dusty climate operation, poor road conditions, high-speed operation, through deep water, etc) more frequent servicing may be required. To determine specific recommendations for servicing your motorcycle, consult your Big Dog Motorcycles Dealer or Authorized Service Center.

Remember, maintenance at regular intervals is required to keep your new motorcycle's warranty in effect. If you or someone other than a Big Dog Motorcycles Dealer or Authorized Service Center performs the required service, you must continuously maintain and retain receipts, logs, and other documentation sufficient to prove that the required maintenance was performed at the proper interval according the maintenance log located in this section.

MAINTENANCE LOG

| |
|--|
| Engine Oil and Filter |
| Air Cleaner Filter |
| Primary Drive Lubricant and Magnetic Plug |
| Primary Drive Chain |
| Clutch |
| Transmission Lubricant and Magnetic Plug |
| Lubricate Clutch Pushrod |
| Drive Belt (with rider on bike) |
| Brake Pads and Rotor (front and rear) |
| Master Cylinder Reservoir Fluid Level and Condition (front & rear) |
| Fluid Lines (oil, brake & fuel) |
| Brake and Clutch Levers and Cables (including throttle cables) |
| Throttle and Enrichener Controls |
| Fuel Valve and Fuel Filter Screen |
| Tires |
| Steering Head Bearings (fork stem and upper fork bracket) |
| Rear Swingarm (pivot arm, pivot shaft nut and shocks) |
| Electrical Components and Switches |
| Spark Plugs |
| Inspect torque of all fasteners excluding engine head bolts |
| Wheel Bearings For Spin |
| Engine Idle Speed |
| Tappet Screen |
| DOWNLOAD IGNITION MODULE TO CUSTOMER SERVICE (AWS) |

R = Replace; I = Inspect, clean, lubricate, adjust, repair or replace if necessary

| 500 MILE | 2,500 MILE | 5,000 MILE | 7,500 MILE | 500 MILE MAINTENANCE |
|----------|------------|------------|------------|-------------------------------|
| R | R | R | R | DATE: _____ MILES: _____ |
| I | I | I | I | DEALER: _____ |
| R | | R | | COMMENTS: _____ |
| I | | I | | _____ |
| I | I | I | I | |
| R | R | R | R | 2,500 MILE MAINTENANCE |
| I | | I | | DATE: _____ MILES: _____ |
| I | | I | | DEALER: _____ |
| I | I | I | I | COMMENTS: _____ |
| I | I | I | I | _____ |
| I | I | I | I | |
| I | I | I | I | 5,000 MILE MAINTENANCE |
| I | I | I | I | DATE: _____ MILES: _____ |
| I | | I | | DEALER: _____ |
| I | | I | I | COMMENTS: _____ |
| I | I | I | I | _____ |
| I | I | I | I | |
| I | I | I | I | 7,500 MILE MAINTENANCE |
| I | | I | | DATE: _____ MILES: _____ |
| I | | I | I | DEALER: _____ |
| I | I | I | I | COMMENTS: _____ |
| I | I | I | I | _____ |
| DOWNLOAD | DOWNLOAD | DOWNLOAD | DOWNLOAD | |

| 10,000 MILE | 12,500 MILE | 15,000 MILE | 17,500 MILE | 10,000 MILE MAINTENANCE |
|-------------|-------------|-------------|-------------|-------------------------|
| R | R | R | R | DATE: MILES: |
| | | | | DEALER: |
| R | R | R | R | COMMENTS: |
| | | | | |
| | | | | |
| R | R | R | R | 12,500 MILE MAINTENANCE |
| | | | | DATE: MILES: |
| | | | | DEALER: |
| | | | | COMMENTS: |
| | | | | |
| | | | | |
| | | | | 15,000 MILE MAINTENANCE |
| | | | | DATE: MILES: |
| | | | | DEALER: |
| | | | | COMMENTS: |
| | | | | |
| | | | | |
| | | | | 17,500 MILE MAINTENANCE |
| | | | | DATE: MILES: |
| | | | | DEALER: |
| | | | | COMMENTS: |
| | | | | |
| DOWNLOAD | DOWNLOAD | DOWNLOAD | DOWNLOAD | |

SERVICE

If you decide to perform the scheduled maintenance, it is essential you have the proper tools, knowledge and skills required. Improper maintenance will cause permanent damage to your motorcycle. In performing any service or maintenance Big Dog Motorcycles recommends the following safety precautions:

1. Wear safety glasses, goggles, or face shield when attempting any maintenance or service operations.
2. The motorcycle must be firmly supported in an upright position.
3. Never support the motorcycle by placing props under the brake pedal as damage could occur, resulting in a possible malfunction.
4. Any oil, solvent or grease on the floor can cause slips that could result in injuries.
5. The engine must not be running while attempting any maintenance or service operations.
6. Disconnect the battery, ground cable first, to avoid accidental start-up of the motorcycle or injuries.
7. When running the engine, adequate ventilation is imperative in preventing carbon monoxide poisoning.
8. To avoid burns, allow the engine and exhaust system to cool.
9. Work in a well-ventilated area while keeping all sparks and flames away from fuel related parts and battery to reduce the possibility of a fire or explosion.
10. Use only non-flammable solvent as parts cleaner.

SERVICE



AIR FILTER This motorcycle is equipped with a dry paper air filter. In order to function properly, the air cleaner must provide an airtight seal between the air cleaner cover and backing plate. Without this complete seal, dirt contaminated air may enter the engine causing rapid wear and possible engine failure. The air filter must be serviced or replaced at 500 miles and every 2,500 miles thereafter. A dry-paper filter cannot be cleaned with any type of solvent or water. If

the air filter is dirty, service using the following steps:

NOTE: California models are equipped with a charcoal impregnated air filter. For servicing, follow the dry paper filter procedure.

1. Remove the three Phillips screws attaching the air cleaner cover to the air cleaner back plate.
2. Remove air filter from the air cleaner back plate.
3. Tap the filter on a flat surface to dislodge any large embedded dirt particles. Use low-pressure air, 15 psi or below, to clean the filter by blowing air through the filter from the inside out. Hold the air nozzle at least three inches from the filter to avoid rupturing.
4. After cleaning, reinstall air filter assembly, tighten the three Phillips screws thoroughly, seating the air cleaner element.
5. Never operate the engine with the air filter removed.

SERVICE

FUEL TANK STRAINER A screen-type fuel strainer is located on top of the supply valve inside the fuel tank. The screen should be inspected and cleaned every service interval. With the gas tank empty (drained through the fuel valve line with the valve set to reserve), carefully unscrew the fuel supply valve from the tank. Inspect and clean the fuel strainer, then reinstall the valve in the fuel tank.



WARNING

BE SURE NO OIL GETS ON THE TIRES WHEN CHANGING THE OIL AND FILTER, AS TRACTION WILL BE ADVERSELY AFFECTED.

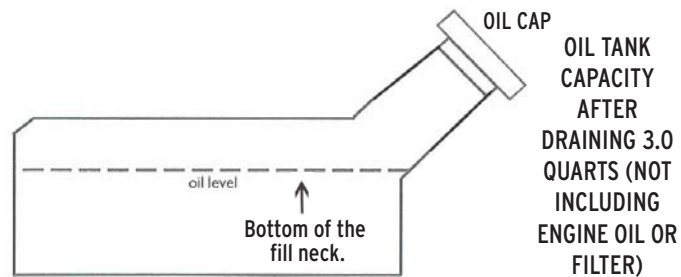

CHECK OIL LEVEL

The oil level should be checked when the engine is at normal operating temperature setting upright and level. The oil level should be visible at the bottom of the fill neck.

SERVICE

ENGINE OIL Use only premium 20W50 V-Twin, detergent motorcycle oil. The quality and cleanliness of your engine oil, as well as maintaining the proper oil level helps prevent wear inside your engine.

CHANGING ENGINE OIL The oil tank should be drained only after the engine has reached normal operating temperature and proceed as follows:

1. Position the motorcycle upright and level. The oil drain is located at the rear of the oil tank.
2. Remove the threaded drain plug and allow oil to drain completely.
3. Clean debris from the drain plug and reinstall. Do not drain the crankcase.
4. Remove the oil filter; clean the gasket contact surface on the oil filter mounting bracket.
5. Apply a thin film of clean motor oil to the oil filter gasket and mounting bracket surface.
6. Screw the filter onto the mounting bracket using only moderate hand pressure. Do not over tighten.
7. With the oil drain securely in place, fill the tank to the proper level (see illustration to the left).
8. Start motorcycle and allow engine to reach operating temperature. Shut off engine and fill tank to proper level (if needed).

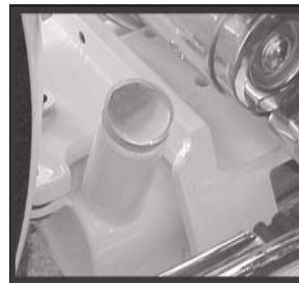

SERVICE



ENGINE OIL FILTER The oil filter is located at the base in the front of the engine. The oil filter should be replaced every time the oil is changed. Use only factory recommended filters.

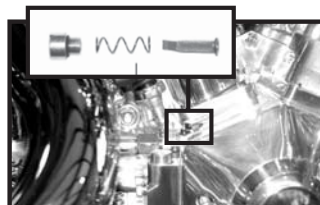

TAPPET OIL FILTER SCREEN The tappet lifter oil filter screen is located in the crankcase above the oil pump. The removal and cleaning of the oil filter screen should take place every service interval or if there is abnormal lifter noise. Use caution when cleaning so not to damage the filter screen when removing. There is a spring under the filter screen cap to hold the filter screen in place. Take care when removing that you retain the spring to reinstall with the filter screen or the filter screen will not be able to perform its function.

WINTER LUBRICATION The oil change interval in winter should be shorter than normal if the motorcycle is used only for short runs. The oil should be drained frequently along with a thorough tank flush with fresh oil before new oil is put in the tank.

TRANSMISSION LUBRICANT The transmission lubricant level should be checked monthly. Big Dog Motorcycles recommends premium V-Twin motorcycle transmission lubricant whereas synthetic lubricants are NOT recommended.



CHECKING TRANSMISSION LUBRICANT LEVEL The transmission lubricant level should be checked only when the drive train is at normal operating temperature.

1. Turn the engine off and position the motorcycle upright and level. Leave the motorcycle in this position for a short period allowing the lubricant level to equalize.
2. Remove the threaded dipstick (see illustration), wipe excess oil off and reinsert until threads on dipstick and filler neck align (DO NOT THREAD).
3. Remove the dipstick and take the reading. The lubricant level should be between the two marks on the dipstick. Transmission capacity is 20 oz. Do not overfill or leakage may occur.
4. Install the dipstick.

SERVICE

CHANGING TRANSMISSION LUBRICANT The transmission lubricant should be changed at all service intervals and every 2,500 miles thereafter. The drain plug is located on the left side trap door bottom center under the transmission case.

1. Unscrew the threaded drain plug to allow fluid to drain.
2. Remove speed sensor and clean any material on it.
3. Replace and secure the drain plug.
4. Fill the transmission case with 20 oz. of lubricant. When draining and refilling the transmission lubricant, insure that dirt and debris do not enter the transmission case.

PRIMARY DRIVE LUBRICANT Use a high-grade primary drive lubricant designed for a wet clutch.

CHECKING PRIMARY DRIVE LUBRICANT LEVEL

1. Position the motorcycle upright and level.
2. Remove screws and washers that secure the inspection cover. Remove inspection cover.
3. Primary lubricant should be at the bottom of the clutch diaphragm spring. This is indicated by lowest starter ring gear teeth being submerged in oil.
4. Add lubricant as required.
5. Replace the O-rings if they are damaged or not sealing properly to avoid lubricant leaking.

SERVICE

6. Note sealant placement on inspection cover. Remove old sealant from primary opening and inspection cover.
7. Install new inspection cover O-rings. Apply new sealant, part number 270-000005-00, to O-rings and inspection cover.

CHANGING PRIMARY DRIVE LUBRICANT

Primary lubricant should be changed initially at 500 miles and every 5,000 miles thereafter. The drain plug is located under the clutch, on the underside of the primary. The filler access is the tensioner inspection cover. To change the primary lubricant and to determine correct lubrication level in the primary, turn the engine off and proceed as follows:

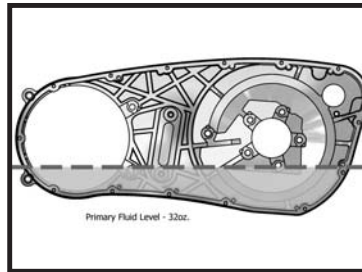

NOTE: Replace O-rings and sealant each time primary lubricant is changed or inspected.

1. Remove the primary inspection cover screws, cover and drain plug allowing the lubricant

SERVICE

to drain. Inspect and clean the magnetic drain plug. Install the drain plug and tighten to 10 ft•lbs torque. Do not over tighten. Fill with 32 oz. of lubricant. For routine maintenance purposes, with bike upright and level, the proper fluid level can be visually checked by looking for partial oil coverage of the internal inner primary casting web as shown.

2. When draining or refilling with lubricant, do not allow dirt or debris to enter the primary. Do not allow lubricant to get on rear wheel, tire or brake components.

PRIMARY DRIVE CHAIN INSPECTION The primary drive chain adjustment should be checked initially at 500 miles and every 2,500 miles thereafter. A loose primary chain may cause the motorcycle to "jerk" at low speeds and lead to excessive wear of the chain and sprockets. See a Big Dog Motorcycles Dealer or Authorized Service Center for proper adjustment.

SERVICE

FRONT FORK OIL Drain and refill the front forks every 5,000 miles or annually. All 2006 models use 10 oz. of 30W synthetic fork oil. Improper fluid level or leaking seals will cause the front forks to malfunction. If the fork does not appear to be working properly or evidence of oil leakage should develop, see a Big Dog Motorcycles Dealer or Authorized Service Center.

LUBRICATION

1. Lubricate throttle control cables with graphite every 2,500 miles.
2. Check steering head bearings for adjustment and lubricate with wheel bearing grease at 500 miles and every 10,000 miles thereafter.
3. Lubricate the side stand with anti-seize every 2,500 miles.
4. All control pivot points may be lubricated regularly, especially after driving in wet weather or after washing.

SERVICE

DRIVE BELT INSPECTION The rear drive belt tension is set at the factory and should be checked along with pulley wear at the 500-mile service and each 2,500 miles thereafter. Inspect the belt for signs of excessive wear, tears, cracks and missing or broken teeth. Replace the belt if any of these conditions are found. The inner tooth surface area of a new belt is coated with a thin layer of polyethylene. This coating will wear off as the motorcycle is ridden and its appearance will change. This is a normal condition and not an indication of belt wear. Too tight or too loose belt tension will cause poor drivability.

SHIFTER LINKAGE ADJUSTMENT The shift linkage can be adjusted without removing the shift rod or eyelets from the shift controls. The shift rod has right and left-handed threads on opposite ends. To adjust the shift lever:

1. Loosen the jam nuts at the base of each shift rod eyelet.
2. Rotate the shift rod clockwise (to the right) to lower the shift lever. Rotate counter clockwise (to the left) to raise the shift lever.
3. Once the lever is adjusted to the desired position, tighten both jam nuts. As the jam nuts are locked into place, the shift rod eyelets must remain in a vertical position. If the eyelets are not aligned vertically, linkage may bind causing difficult shifting.

SERVICE

FRONT AND REAR BRAKE INSPECTION Initially, check your front and rear brakes at 500 miles then every 2,500 miles thereafter. If you ride under adverse conditions like steep hills or heavy traffic, more frequent inspection may be necessary. Visual inspection of brake pads can be made without removing the caliper by viewing the lower area of each caliper with the aid of a flashlight. If brake pad material is 1/16" in thickness (the thickness of a nickel) the pad must be replaced immediately. Do not ignore this routine maintenance as damage could occur. Replace brake pads in pairs only. Check the brake caliper position on both brake discs. The discs should be centered between the brake pads. If the pads are not centered, or you have any other brake related problem, contact a Big Dog Motorcycles Dealer or Authorized Service Center.

SERVICE

BRAKE LINE AND MASTER CYLINDER INSPECTION AND SERVICING

Whenever you inspect the brake pads and discs, also inspect the brake lines, connections, master cylinders and calipers for leakage. To service the front brake master cylinder:

1. Stand the motorcycle on its side stand.
2. Turn the handlebars until the front brake master cylinder lid is close to level (you may need assistance to keep the front handlebars in this position).
3. Remove the master cylinder lid and visually check for fluid at the undercut inside the reservoir.

To service the rear brake master cylinder:

1. Stand the motorcycle upright and level.
2. Remove the master cylinder cover and visually check for fluid at the undercut inside the reservoir.



WARNING

USE ONLY DOT 5 BRAKE FLUID IN YOUR BIG DOG MOTORCYCLES BRAKE SYSTEM. THE FRONT WHEEL MASTER CYLINDER IS LOCATED BESIDE THE FRONT BRAKE HAND LEVER.

CARBURETOR CONTROLS The throttle control and idle speed adjustment screw should only be adjusted by a Big Dog Motorcycles Dealer or Authorized Service Center.

SERVICE

CLUTCH CABLE INSPECTION AND ADJUSTMENT The clutch cable should be checked, lubricated and adjusted at all service intervals and every 2,500 miles thereafter. If you experience slippage with the clutch engaged (clutch lever released) or dragging with the clutch disengaged (clutch lever pulled in) see a Big Dog Motorcycles Dealer or Authorized Service Center.

ALTERNATOR CHARGING RATE AND VOLTAGE REGULATOR The alternator output is controlled by the voltage regulator. This unit requires no scheduled maintenance. If any electrical system trouble is experienced that might be related to the alternator or voltage regulator, contact a Big Dog Motorcycles Dealer or Authorized Service Center.

BATTERY SERVICING AND INSTALLATION This motorcycle is equipped with a maintenance free battery. Battery connections should be cleaned and torqued to 60 in lbs. every 2,500 miles. To service the battery:

1. Remove the seat.
2. Disconnect battery cables (negative first, positive last).
3. Clean the cable connectors and battery terminal with a wire brush or sandpaper to remove oxidation.
4. Connect the cables to the proper terminals (positive first, negative last). Do not over tighten terminal connections.
5. Reinstall seat.

SERVICE

Batteries can lose some of their charge even with the ignition turned off. Discharge rate depends on the storage temperature and the condition of the battery. After 30 days of non-use, the battery may not have sufficient cranking power to start the motorcycle. Big Dog Motorcycles recommends using the BDM250-00004 trickle charger in order to maintain sufficient cranking power. No other charger is recommended by Big Dog Motorcycles. DO NOT use an automotive battery charger.



WARNING

CONNECTING CABLES TO THE WRONG BATTERY TERMINALS CAN CAUSE SERIOUS DAMAGE TO THE MOTORCYCLE'S ELECTRICAL SYSTEM.

DO NOT INSTALL ACCESSORY PLUG WIRES (NEON, TAYLOR, ETC.) THE ELECTROMAGNETIC INTERFACE NOISE FROM THE ACCESSORY PLUG WIRES WILL CAUSE IGNITION ISSUES.

SPARK PLUG/PLUG WIRE INSPECTION AND REPLACEMENT Inspect and/or replace the spark plugs at 500 miles and every 2,500 miles thereafter. To disconnect the spark plug wires from the plugs, pull on the molded connector boots. The connection is a "snap" type. Grasp the rubber wire boot, not the wire. Pulling on the wire may damage the internal conductor.

SERVICE

The spark plug gap should be 0.040 inches. Make sure that the new spark plugs are the same type as the ones being replaced: Champion® RA8HC. Spark plugs should be torqued to 14 ft•lbs. If the engine seems to be running on only one cylinder, check the spark plug wire connection at both ends.

HEADLIGHT REPLACEMENT The headlight has a replaceable quartz halogen bulb. When replacing a halogen bulb never touch the glass portion with your bare fingers. Oil contamination will reduce bulb life. Always wrap the bulb in clean paper or a clean dry cloth during handling. Do not attempt to remove bulb while it is still hot.

TURN SIGNALS The turn signals for this motorcycle are designed for brighter illumination and longevity. Substitution with any other type or brand of turn signal will disrupt the operation of the electrical system. For parts and service, contact a Big Dog Motorcycles Dealer or Authorized Service Center.

CLEANING

WARNING

OBSERVE WARNINGS AND CAUTIONS GIVEN ON LABELS OF CLEANING PRODUCTS TO PREVENT DAMAGE TO YOUR MOTORCYCLE. DO NOT WASH YOUR BRAKE DISCS WITH ANY CLEANERS THAT CONTAIN EITHER CHLORINE OR SILICONE.

WHEN WASHING YOUR MOTORCYCLE, BE CAUTIOUS NOT TO EXPOSE THE BRAKES, ENGINE, MUFFLER, INSTRUMENTS, AIR CLEANER, WHEEL BEARING OR PAINTED AREAS TO HIGH-PRESSURE SPRAY. USE OF A HIGH-PRESSURE SPRAY OR PRESSURE WASHER IS NOT RECOMMENDED. A WET ENGINE COULD BE HARD TO START AND MAY NOT RUN WELL UNTIL DRY. START THE ENGINE IMMEDIATELY AFTER WASHING AND BE SURE THE BRAKES AND ENGINE ARE OPERATING PROPERLY BEFORE RIDING.

DO NOT GET ANY CLEANERS, WAXES, POLISHES OR OTHER COMPOUNDS ON YOUR BRAKE COMPONENTS. FOREIGN MATERIALS MAY REDUCE BRAKING EFFICIENCY.

GENERAL CLEANING Care should be taken to keep your new motorcycle clean to inhibit rust and corrosion. Chrome and aluminum parts must be maintained regularly to ensure that they retain their original shine and luster. To aid in preserving your motorcycles' finish, see a Big Dog Motorcycles Dealer or Authorized Service Center for approved cleaning and polishing products.

CLEANING

CHROME Use a chrome polish to shine your chrome. Multipurpose cleaners are not recommended.

LEATHER Many accessories and seats are either made of leather or have a leather insert. Natural materials require different care than man made materials. Leather must be periodically cleaned and treated to maintain its appearance and extend its life. Use only products that are specifically made for leather on your leather accessories.

PAINT is one of the distinguishing characteristics of your motorcycle. The following tips help keep your paint looking its best:

1. DO NOT APPLY ANY WAX PRODUCT FOR THE FIRST 90 DAYS. DO NOT USE SILICONE-BASED WAXES, POLISHES OR CLEANERS.
2. DO NOT APPLY ANY WAX PRODUCT, EVER, TO TO A MATTE FINISH.
3. When not riding your motorcycle, keep it inside. If it must remain outdoors, make sure to keep it protected with a high quality motorcycle cover. Over time, wind, rain and daily exposure to sunlight all take their toll on the finish if not properly protected.
4. Using an approved applicator, apply and remove wax in the same way the paint was applied, in a back and forth motion following the contour of the surface. This avoids etching swirl marks into the finish. Remove any abrasive particles from the painted

CLEANING

surfaces and use a clean applicator with a non-abrasive polish to avoid scratching your paint.

5. Wipe off gasoline immediately. The chemicals and additives in gasoline can dull or fog your paint if allowed to remain on the paint.
6. Use only approved cleaners on your paint. Harsh cleaners may work great for removing road tar but also may damage your paint.
7. Avoid constant contact (rubbing) with any clothing or travel gear on your paint.



WARNING

DO NOT WASH YOUR MOTORCYCLE WITH COOL WATER WHEN THE PAINT HAS BEEN HEATED BY DIRECT SUNLIGHT. THIS CAN BREAK THE BOND BETWEEN THE PAINT AND THE METAL SURFACE. DO NOT APPLY POWER WASH DIRECTLY ON THE PAINTED SURFACES AS THIS CAN DAMAGE THE PAINT.

STORAGE Proper long term storage is important for trouble-free operation of your motorcycle. If you do not wish to perform these tasks, contact a Big Dog Motorcycles Dealer or Authorized Service Center. They have trained technicians who can complete the work according to Service Manual procedures.

STORAGE

PREPARING YOUR MOTORCYCLE FOR STORAGE There are things to do if your motorcycle will not be operated for several months. To protect parts against corrosion, preserve the battery and prevent the build up of deposits in the carburetor the following steps are recommended to prepare your motorcycle for storage:

1. Change the oil and filter.
2. Fill the fuel tank and add a gasoline stabilizer.
3. Run the motorcycle for 1-2 minutes to circulate the fresh oil and give the stabilizer a chance to reach the carburetor.
4. Check condition of the drive belt.
5. Inflate tires to proper pressure.
6. Wash painted surfaces.
7. Remove battery.

If the motorcycle is to be covered, use a material such as light canvas that will breathe. Plastic materials trap condensation against the surfaces of your motorcycle.

WARNING

FUEL IS FLAMMABLE. DO NOT STORE A MOTORCYCLE WITH GASOLINE IN THE TANK INSIDE YOUR HOME OR GARAGE IF THERE ARE OPEN FLAMES, PILOT LIGHTS, SPARKS OR ELECTRIC MOTORS PRESENT.

STORAGE

REMOVING YOUR MOTORCYCLE FROM STORAGE When removing your motorcycle from storage, here is a checklist of things you will need to do prior to riding:

1. Remove and inspect the spark plugs. Replace if necessary.
2. Check and clean or replace the air filter.
3. Reinstall battery.
4. Start the engine and run until it reaches normal operating temperature. Then turn off the engine.
5. Check the oil level.
6. Check the transmission lubricant level.
7. Check controls for proper operation.
8. Check steering smoothness through full turning radius.
9. Check tire pressure.
10. Check all electrical equipment including turn signals, headlight (low and high beam) brake light and horn.
11. Check for any fuel, oil or brake fluid leaks.

TROUBLE-SHOOTING

TROUBLE-SHOOTING GUIDE The trouble-shooting guide provides only the most common problem/solutions.

ENGINE

STARTER DOES NOT OPERATE OR DOES NOT TURN ENGINE OVER:

1. Engine run switch in OFF position.
2. Ignition switch not on.
3. Discharged battery, loose, corroded or broken connections (solenoid chatters).

ENGINE TURNS OVER BUT DOES NOT START:

1. Fuel valve turned off (low fuel requires the fuel valve to be turned to reserve).
2. Fuel tank empty.
3. Engine flooded with fuel.
4. Fouled spark plugs.
5. Fuel valve clogged.
6. Spark plug cable connections loose or in bad condition and shorting.
7. Throttle held open when enrichener is used.
8. Loose or corroded wire or cable connection(s) at coil.

HARD TO START:

1. Throttle held open when enrichener used.
2. Fuel tank cap vent plugged or carburetor fuel line closed off, restricting fuel flow.
3. Spark plugs in bad condition.

TROUBLE-SHOOTING

4. Loose wire or cable connection(s) at one of the battery terminals or at coil.
5. Spark plug cables in bad condition.
6. Battery nearly discharged.
7. Carburetor not adjusted correctly.
8. Water or dirt in fuel system and/or carburetor.
9. Engine oil too viscous (winter operation).

STARTS, BUT RUNS IRREGULARLY OR MISSES:

1. Spark plugs in bad condition or partially fouled.
2. Spark plug cables in bad condition or have become detached (check both ends of each spark plug cable).
3. Spark plug gap too close or too wide.
4. Battery nearly discharged.
5. Damaged wire/loose connection at battery terminals or coils.
6. Intermittent short circuit due to damaged wire insulation.
7. Water or dirt in fuel system.
8. Fuel vent system plugged.
9. Air leak in intake manifold.
10. Air filter clogged.

SPARK PLUG FOULS REPEATEDLY:

1. Excessive enrichener use.
2. Fuel mixture too rich.

TROUBLE-SHOOTING

3. Incorrect spark plug or plug gap.
4. Air filter clogged.
5. Excessive "pumping" of the throttle grip.

PREIGNITION OR DETONATION (KNOCKS OR PINGS):

1. Incorrect fuel.
2. Incorrect spark plug.
3. Incorrect ignition timing.
4. Insufficient oil supply or oil circulation.
5. Heavy carbon deposit from "lugging" engine.
6. Carburetor set too lean.
7. No air flow over engine (i.e. stopped in traffic).

EXCESSIVE VIBRATION:

1. Front or rear engine mounting bolts loose.
2. Transmission mounting bolts loose.
3. Wheels and/or tires damaged or out of balance.
4. Vehicle not properly aligned.
5. Final drive belt badly worn.
6. Primary drive chain badly worn or links tight as a result of insufficient lubrication or improper adjustment.

TROUBLE-SHOOTING

LUBRICATION SYSTEM

OIL DOES NOT RETURN TO OIL TANK:

1. Oil tank empty.
2. Restricted oil lines or fittings.
3. Restricted oil filter.
4. Internal motor damage.

ENGINE LEAKS OIL FROM CASE, PUSH RODS, HOSES:

1. Loose parts.
2. Imperfect seal at gasket, push rod cover, washers, etc.
3. Restricted oil return line to tank.

ELECTRICAL SYSTEM

ALTERNATOR DOES NOT CHARGE:

1. Regulator not grounded or defective.
2. Engine ground wire loose or broken.
3. Malfunction in charging system.

ALTERNATOR CHARGE RATE IS BELOW NORMAL:

1. Weak battery.
2. Excessive use of add-on accessories.
3. Loose or corroded connections.
4. Extensive periods of idling or low speed riding.
5. Malfunction in charging system.

TROUBLE-SHOOTING

CLUTCH SYSTEM

DRAGS OR DOES NOT RELEASE:

1. Clutch controls improperly adjusted.
2. Clutch steel discs warped.

CLUTCH SLIPS:

1. Clutch controls improperly adjusted.
2. Worn friction discs.
3. Insufficient clutch spring attitude.

CLUTCH CHATTERS:

1. Friction disc or steel discs worn or warped.

TRANSMISSION

HARD TO SHIFT:

1. Transmission shifting mechanism needs adjustment.
2. Bent shifter fork.
3. Clutch out of adjustment.

TRANSMISSION JUMPS OUT OF GEAR:

1. Shifter rod improperly adjusted.
2. Shifter fork bent (inside transmission).
3. Worn shifter clutch gears in transmission.

TROUBLE-SHOOTING

BRAKES

POOR BRAKE PERFORMANCE:

1. Front and/or rear master cylinder low on fluid.
2. Air bubbles in the hydraulic system.
3. Contaminated brake pad/disc.
4. Brake pads badly worn (1/16 in. minimum lining thickness).
5. Brake discs badly worn or warped.
6. Brake fades because of heat build up due to:
 - a. Excessive braking (riding the brakes).
 - b. Brake pads dragging.
 - c. Insufficient hand lever or rear pedal free play.
7. Master or caliper pistons worn.



SECTION 4

WARRANTY

Warranty | Warranty Transfer

WARRANTY

This Manufacturer's Limited Warranty is between BIG DOG MOTORCYCLES, L.L.C. , and you, the owner (OWNER).

Your motorcycle is warranted against defects in materials and workmanship for a period of two (2) years, with the exception of defects in paint and chrome, which are warranted for a period of six (6) months. BIG DOG MOTORCYCLES will be the sole arbitrator of defective paint. A defect is defined as the failure of an original part, or of a replacement part of the same quality, to function as it was designed, in normal use, when properly operated and maintained.

The term of this Manufacturer's Limited Warranty shall begin on the date the motorcycle is delivered to the first retail purchaser, or, if the motorcycle is placed into service as a demonstrator or company vehicle prior to sale at retail, on the date it is first placed in service.

Warranty services will be performed within a reasonable time after notification of a claim, subject to inspection and factory authorization, at any BIG DOG MOTORCYCLES Dealer or Authorized Service Center. Warranty will be provided during normal business hours and scheduled by the provider, consistent with existing workloads and parts availability. Any part(s) replaced under this warranty shall become the property of BIG DOG MOTORCYCLES.

WARRANTY

TRANSFER OF WARRANTY This Manufacturer's Limited Warranty is, in most instances, transferable to a subsequent owner. However, BIG DOG MOTORCYCLES reserves the right to decline the transfer of the remainder of the warranty to subsequent owners under certain circumstances. It is the duty of subsequent purchasers to determine, prior to purchase, if the warranty is transferable. BIG DOG MOTORCYCLES must receive a copy of the Warranty Transfer Form within 30 days of the transfer of ownership, plus a \$50 warranty transfer fee payable to BIG DOG MOTORCYCLES.

PARTS AND LABOR NOT COVERED Items or situations not covered include, but are not limited to the following:

1. Batteries, drive belt, brake pads, light bulbs, throttle cables, choke cable, and clutch control cable, fasteners, and connectors (including but not limited to: bolts, clips, nuts, pins and screws), filters, fluids, or other maintenance items, tires, finish on polished metal, exhaust discoloration, squeaks, chirps, or rattles.
2. Damage caused by exceeding manufacturer's recommended weight and/or recommended rider limits.
3. Any regular or required maintenance services described in this OWNER'S MANUAL and other normal maintenance services and parts which include, but are not limited to: alignments, mechanical adjustments, shipping and handling, cleaning, wheel balancing, diagnostic time, test rides, shop supplies and environmental/hazardous waste charges, storage, taxes, freight.

WARRANTY

4. Damage and/or breakdown resulting from collision, fall over or upset, road hazard, fire, theft, attempted theft, malicious mischief, vandalism, riot, fire, explosion, lightning, earthquake, tornado, windstorm, sand storm, volcanic eruption, freezing, civil or governmental commotion, rust and corrosion, hail, snow, extreme water or flood, rotting, punctures, natural perils or acts of God, salt, environmental damage, falling objects, chemicals, cleaners, corrosives, high pressure wash, contamination of fluids, fuels, or lubricants, delay or failures in authorized repair and/or replacement services from the aforementioned causes, or other causes beyond control of BIG DOG MOTORCYCLES.
5. Any damage and/or breakdown caused by negligence, lack of scheduled maintenance, improper servicing or repairs performed by owner or an unauthorized repair facility, for any breakdown caused by use of wrong lubricants, blockage or the failure to maintain proper levels of lubricants, or any breakdown resulting from failure to protect vehicle from further damage when breakdown has occurred.
6. Damage resulting from the failure of any custom or add-on part, any frame or suspension modifications, lift or lowering kits, fork extensions, oversized/undersized tires, trailer hitches, engine modifications, carburetor, exhaust or emissions modifications, cam change, lighting/signal additions or modifications to the wiring, non-conforming replacement parts which adversely affect performance.

WARRANTY

7. Any vehicle that does not have a valid manufacturer's VIN or title branded as salvage, junk, rebuilt, totaled, or flood damaged. Any motorcycle on which the odometer mileage has been changed so that actual mileage cannot be readily determined is not covered.
8. Damage to paint from any cause other than factory defects. Specifically, fading caused by over exposure to direct sunlight, rock chips, abuse, road debris abrasion or overfilling of the fuel tank(s).
9. Any claims, if your vehicle is used for towing a trailer or another vehicle or object or is used as a commercial unit, or is used for rental, taxi, or shuttle, delivery, construction/job site activities, hauling, police or emergency service, off-road use, racing or competitive riding, or route work.
10. Any breakdowns that occur to your vehicle outside the United States or Canada.
11. Damage caused by failure to follow recommended BIG DOG MOTORCYCLES engine break-in procedures, including exceeding RPM limitations or low RPM operation (below 1,000). Evidence of abuse or failure to adhere to the recommended break-in procedure will void the engine/drive train warranty.

LIMIT OF LIABILITY The following are express limits of your BIG DOG MOTORCYCLES Warranty.

WARRANTY

1. Repair or replacement of defective components.
 - PICK-UP/TOWING - In the event of a mechanical breakdown caused by a defect in a Covered Component, BIG DOG MOTORCYCLES will reimburse the OWNER for reasonable pick-up and towing charges to transport the motorcycle to a BIG DOG MOTORCYCLES Dealer or Authorized Service Center. Maximum allowance per occurrence is \$100 and is subject to the terms and conditions of the current towing policy.

 - IN THE EVENT OF A MECHANICAL BREAKDOWN To obtain performance under this Manufacturer's Limited Warranty, OWNER must either return the motorcycle at OWNER'S expense to a BIG DOG MOTORCYCLES Dealer or Authorized Service Center, or to BIG DOG MOTORCYCLES, 1520 E. Douglas, Wichita, KS 67214. Follow these procedures:
 1. Use all reasonable means to protect your motorcycle from further damage that may result from continued operation.
 2. Contact BIG DOG MOTORCYCLES Customer Service to obtain the name of the nearest authorized repair facility.

 - MISCELLANEOUS
 1. OWNER agrees that he will not abandon the motorcycle to a dealer or to BIG DOG MOTORCYCLES.

WARRANTY

2. Authorized Dealers are independently owned and operated and BIG DOG MOTORCYCLES is not responsible in any way for any parts, labor, alterations or modifications made to said motorcycle. Dealers are not an agent and cannot provide a warranty.

LEGAL RIGHTS THIS MANUFACTURE'S LIMITED WARRANTY IS IN LIEU OF ALL OTHER WARRANTIES WHETHER ORAL, WRITTEN, EXPRESSED, OR IMPLIED. BIG DOG MOTORCYCLES' OBLIGATIONS AND OWNER'S REMEDIES, HEREUNDER, ARE SOLELY AND EXCLUSIVELY AS STATED. BIG DOG MOTORCYCLES' LIABILITY FOR INCIDENTAL AND CONSEQUENTIAL DAMAGES INCLUDING, BUT NOT LIMITED TO, PERSONAL INJURY, OR DEATH OF ANY PERSON, ARISING OUT OF THE OPERATION, MAINTENANCE, OR USE OF YOUR VEHICLE, PHYSICAL DAMAGE, PROPERTY DAMAGE, LOSS OF USE OF THE MOTORCYCLE, LOSS OF TIME, INCONVENIENCE, AND COMMERCIAL LOSS RESULTING FROM THE OPERATION, MAINTENANCE, OR USE OF THE MOTORCYCLE IS EXPRESSLY EXCLUDED. THERE ARE NO WARRANTIES OF MERCHANTABILITY OR FITNESS FOR A PARTICULAR USE OR PURPOSE. THE PROVISIONS OF THIS PARAGRAPH DO NOT APPLY TO SALES MADE IN THE STATE OF KANSAS TO "CONSUMERS" AS THE TERM IS DEFINED IN K.S.A. 50-624. SOME STATES DO NOT ALLOW LIMITATIONS ON HOW LONG AN IMPLIED WARRANTY LASTS, OR DO NOT ALLOW THE EXCLUSION OR LIMITATIONS OF INCIDENTAL OR CONSEQUENTIAL DAMAGES, SO THE ABOVE LIMITATIONS MAY NOT APPLY TO YOU. THIS WARRANTY GIVES YOU SPECIFIC LEGAL RIGHTS AND YOU MAY ALSO HAVE OTHER RIGHTS, WHICH VARY FROM STATE TO STATE.

WARRANTY

In addition to this Limited Warranty, the motorcycle is covered by the Emissions System Warranty that follows:

YOUR WARRANTY RIGHTS AND OBLIGATIONS The California Air Resources Board is pleased to explain the emission control system warranty on your 2006 BIG DOG MOTORCYCLES motorcycle. In California, new motor vehicles must be designed, built and equipped to meet the State's stringent anti-smog standards. BIG DOG MOTORCYCLES must warrant the emission control system on your motorcycle for the periods of time listed below provided there has been no abuse, neglect or improper maintenance of your motorcycle. Your emission control system may include parts such as the carburetor or fuel injection system, the ignition system, catalytic converter, and engine computer. Also included may be hoses, belts, connectors and other emission related assemblies. Where a warrantable condition exists, BIG DOG MOTORCYCLES will repair your motorcycle at no cost to you including diagnosis, parts and labor.

LIMITED WARRANTY ON EMISSION CONTROL SYSTEM BIG DOG MOTORCYCLES warrants that each new BIG DOG MOTORCYCLES motorcycle is designed, built and equipped to conform at the time of initial retail purchase with all applicable regulations of the United States Environmental Protection Agency. Each new motorcycle that is manufactured to be subject to the laws of the State of California conforms to all applicable regulations of the California Air Resources Board. The motorcycle is free from defects in material and workmanship that would cause such motorcycle to fail to conform

WARRANTY

to applicable regulations of the United States Environmental Protection Agency and, if applicable, the California Air Resources Board within 5 years or 18,641 miles (30,000 kilometers) whichever occurs first. Warranty defects shall be remedied during customary business hours at any Authorized Dealer in compliance with the Clean Air Act and applicable regulations of the United States Environmental Protection Agency and, if applicable, the California Air Resources Board.

State of California Only: Emission related warranted parts are specifically defined by the state's Emission Warranty Parts List. These warranted parts are: carburetor and internal parts; intake manifold; fuel tank(s), fuel tank cap for evaporative emission controlled vehicles; fuel/vapor separator; canister; ignition coil; ignition wires; and spark plugs if failure occurs prior to the first scheduled replacement; and hoses, clamps, fittings and tubing used directly in these parts. Since emission related parts may vary from model to model, certain models may not contain all of these parts and certain models may contain functionally equivalent parts. Emission Control System emergency repairs, as provided for in the California Administrative Code, may be performed by service centers other than an Authorized Dealer or by any individual.

An emergency situation occurs when an Authorized Dealer is not reasonably available, a part is not available within 30 days, or a repair is not complete within 30 days. Any replacement part can be used in an emergency repair. BIG DOG MOTORCYCLES will reimburse the OWNER for the expenses, including diagnosis, not to exceed BIG DOG MOTORCYCLES'

WARRANTY

suggested retail price for all warranted parts replaced and labor charges based on BIG DOG MOTORCYCLES' recommended time allowance for the warranty repair and the geographically appropriate hourly labor rate. The OWNER will be required to provide receipts and return the failed parts to BIG DOG MOTORCYCLES in order to receive compensation. For five years or 30,000 kilometers (18,641 miles), whichever first occurs, if an emission-related part on your motorcycle is defective, the part will be repaired or replaced by BIG DOG MOTORCYCLES. This is your emission control system defects warranty. As the motorcycle owner, you are responsible for the performance of the required maintenance listed in your OWNER'S MANUAL. BIG DOG MOTORCYCLES recommends that you retain all receipts covering maintenance on your motorcycle, but BIG DOG MOTORCYCLES cannot deny warranty solely for the lack of receipts or for your failure to ensure the performance of all scheduled maintenance. You are responsible for presenting your motorcycle to a BIG DOG MOTORCYCLES dealer as soon as a problem exists. The warranty repairs should be completed in a reasonable amount of time, not to exceed 30 days.

If you have any questions regarding your warranty rights and responsibilities, you should contact BIG DOG MOTORCYCLES, at: 316-219-6504, or the California Air Resources Board at 9528 Telstar Avenue, El Monte, CA 91731.

LIMITATIONS UNDER EMISSION CONTROL SYSTEM WARRANTY The warranty period shall begin on the date the motorcycle is delivered to the first retail purchaser, or, if the motorcycle is placed in service as a demonstrator or company vehicle

WARRANTY

prior to sale at retail, on the date it is first placed in service.

The liability of BIG DOG MOTORCYCLES is limited solely to the remedying of defects in material or workmanship by an Authorized Dealer at their place of business during customary business hours. These warranties do not cover inconvenience or loss of use of the motorcycle.

OWNER'S WARRANTY RESPONSIBILITIES This Manufacturer's Limited Warranty will be maintained if BIG DOG MOTORCYCLES' recommended service is performed by a factory Authorized Dealer, or other service facility with evidence of having provided reasonable and necessary maintenance to all covered components. As the motorcycle OWNER, you should be aware that BIG DOG MOTORCYCLES will void your warranty coverage if your motorcycle or a part has failed due to abuse, neglect, improper maintenance or unapproved modifications.

1. The OWNER must keep a maintenance log validated by the servicing dealer and keep receipts and work orders showing the date, mileage, and service performed.
2. In the event the OWNER, or someone other than the dealer, performs the required service, the OWNER must continuously maintain and retain receipts, logs, and other documentation sufficient to prove that the required maintenance was performed at the proper time and mileage according to the Maintenance Log that is found on page 51 of this OWNER'S MANUAL.

WARRANTY

TAMPERING WITH NOISE CONTROL SYSTEM PROHIBITED Federal law prohibits the removal or rendering inoperative by any person other than for purposes of maintenance, repair, or replacement, of any device or element of design incorporated into any new vehicle for the purpose of noise control prior to its delivery to the ultimate purchaser or while it is in use, or the use of the vehicle after such device or element of design has been removed or rendered inoperative by any person. Among those acts presumed to constitute tampering are listed below:

1. Modification or removal of the muffler and/or replacement of the exhaust system with one that is not EPA compliant for use on a street vehicle.
2. Modification to the air intake breather or replacement with a type that increases the noise level above the current standard.

BIG DOG MOTORCYCLES recommends that any noise related repair or maintenance be performed by a BIG DOG MOTORCYCLES Dealer or Authorized Service Center.

REPORTING SAFETY DEFECTS Required by the National Highway Traffic Safety Administration (NHTSA). If you believe that your vehicle has a defect which could cause a crash or could cause injury or death, you should immediately inform the National Highway Traffic Safety Administration (NHTSA) in addition to notifying BIG DOG MOTORCYCLES. If NHTSA receives similar complaints, it may open an investigation, and if it finds that a safety defect exists in a group of vehicles, it may order a recall and remedy campaign. However, NHTSA cannot become involved in individual problems between you, your dealer,

WARRANTY

or BIG DOG MOTORCYCLES. To contact NHTSA, you may either call the Auto Safety Hotline toll-free at 1-800-424-9393 or (202) 366-0123 in the Washington D.C. area) or write to: NHTSA, U.S. Department of Transportation, 400 7th Street S.W., (NASS-11) Washington, DC. 20590. You can also obtain other information about motor vehicle safety from the Hotline.

NOTICE OF WARRANTY DISPUTE RESOLUTION PROGRAM BIG DOG MOTORCYCLES has in place an informal dispute settlement mechanism, established in compliance with Federal Trade Commission Regulations, published at 16 C.F.R. Part 703. OWNER is required to resort to this alternative dispute resolution program before exercising rights or seeking remedies under the federal Magnuson-Moss Warranty Act, 15 U.S.C. §2301, et seq.

OWNER may be required to resort to this alternative dispute resolution program before exercising rights or seeking remedies under certain state consumer laws and "lemon law" statutes. These requirements vary from state to state, and are independent of the requirements of the federal Magnuson-Moss Warranty Act. 15 U.S.C. §2301, et seq.

OWNER and BIG DOG MOTORCYCLES shall submit any dispute arising under this Warranty, to arbitration in accordance with the Rules of the Better Business Bureau (BBB). A volunteer BBB arbitrator will render a decision that the arbitrator considers to be fair. In doing so, the arbitrator is not required to apply legal principles. If OWNER accepts the arbitrator's

WARRANTY

decision, BIG DOG MOTORCYCLES will be bound to abide by the decision and comply with its terms (subject to any limited right of review that may be provided by state or federal law); the OWNER must comply with the terms of the decision; and OWNER gives up the right to sue BIG DOG MOTORCYCLES in court on any claim that has been resolved at the arbitration hearing unless BIG DOG MOTORCYCLES fails to perform according to the arbitrator's decision (or unless otherwise provided by state or federal law). If OWNER rejects the arbitrator's decision, OWNER may pursue other legal remedies under state or federal law; and BIG DOG MOTORCYCLES will not be obligated to perform any part of the decision.

When filing a claim with the BBB, OWNER shall provide, at a minimum, the following information: make and model, vehicle identification number, date of purchase, place of purchase, current odometer reading, a list of all complaints, and a copy of all repair orders and any other documentation to support OWNER'S claim(s). BIG DOG MOTORCYCLES shall have ten (10) days from the receipt of written notice from the BBB that OWNER has filed a claim and requested an arbitration hearing within which to respond to OWNER'S claim. OWNER shall then have ten (10) days from the receipt of BIG DOG MOTORCYCLES' response within which to respond to the same. Simultaneously, the BBB shall obtain a hearing date, said hearing to take place within forty (40) days of the original filing of OWNER'S claim and request for arbitration with the BBB.

All administrative fees, except for attorney fees, for the arbitration process will be paid

WARRANTY

by BIG DOG MOTORCYCLES. For more information about the BBB arbitration process, or to file a claim with this mechanism, OWNER may write to:

Better Business Bureau of Wichita
328 S. Laura
Wichita, KS 67211
or call toll-free 1-800-856-2417.

This Arbitration process affects important legal rights, and OWNER should check with an attorney with any QUESTIONS ABOUT THOSE rights.

NOTE: The foregoing Notice regarding arbitration, established in accordance with the Rules of the Better Business Bureau to settle any Warranty disputes that may arise with OWNER'S BIG DOG MOTORCYCLES motorcycle, is set forth in part, and acknowledged by OWNER, in a separate document furnished to OWNER at the time of sale, entitled "Notice of Warranty Dispute Resolution Program," and is set forth in its entirety in this WARRANTY SECTION to satisfy applicable state and federal compliance requirements (16 C.F.R. Part 703) and for OWNER'S reference.

STATE WARRANTY ENFORCEMENT LAWS The laws of many states permit

WARRANTY

owners to obtain a replacement vehicle or a refund under certain circumstances. In some states, the law requires that you first notify the manufacturer in writing of a problem so that the manufacturer has an opportunity to make any needed repairs, before you are eligible for remedies these laws provide. Your written notification should be sent to:

BIG DOG MOTORCYCLES
Attn: Warranty Dept.
1520 E. Douglas Avenue
Wichita, KS 67214

NOTE: When writing to BIG DOG MOTORCYCLES, you will need to provide your name, address, phone number, vehicle model, vehicle identification number, date of purchase, current odometer reading, the name of your BIG DOG MOTORCYCLES Dealer and a description of the problem.

WARRANTY TRANSFER

OWNER'S NAME: _____

ADDRESS: _____

City/State/Zip: _____

PHONE: _____ **EMAIL:** _____

VIN: _____

CHOPPER K-9 MASTIFF PITBULL RIDGEBACK

DEALERSHIP: _____

DATE OF PURCHASE: _____ **MILES AT PURCHASE:** _____

PURCHASE PRICE: _____ **IGNITION KEY #:** _____

MAIL TO: Big Dog Motorcycles, 1520 E. Douglas, Wichita, KS 67214

California residents only: failure to complete and return this form does not diminish your warranty rights.

2006 RIDGEBACK WARRANTY TRANSFER



Please mail this Warranty Transfer to:
Big Dog Motorcycles, 1520 E. Douglas, Wichita, KS 67214

WARRANTY TRANSFER

OWNER'S NAME: _____

ADDRESS: _____

City/State/Zip: _____

PHONE: _____ **EMAIL:** _____

VIN: _____

CHOPPER K-9 MASTIFF PITBULL RIDGEBACK

DEALERSHIP: _____

DATE OF PURCHASE: _____ **MILES AT PURCHASE:** _____

PURCHASE PRICE: _____ **IGNITION KEY #:** _____

MAIL TO: Big Dog Motorcycles, 1520 E. Douglas, Wichita, KS 67214

California residents only: failure to complete and return this form does not diminish your warranty rights.

2006 RIDGEBACK WARRANTY TRANSFER



Please mail this Warranty Transfer to:
Big Dog Motorcycles, 1520 E. Douglas, Wichita, KS 67214