

WORKSHOP MANUAL

FOR THE

RABBIT SUPERFLOW MOTOR SCOOTER

MODEL S601B



www.ClassicCycles.org

ENGINE

FUJI HEAVY INDUSTRIES LIMITED

ENGINE

Classic Cycles Technical Resources

INDEX

1. General Data	1
2. Engine Specifications	2
3. Construction	4
3-1. Engine and Transmission System	4
3-2. Ignition System	6
3-3. Lubrication	6
3-4. Carburetor	7
3-5. Electric Components	10
3-6. Spark Plug	10
3-7. Operating Principles of Starter Dynamo	11
3-8. Regulator	11
4. Disassembly and Cleaning	13
4-1. Special Tools	14
4-2. Disassembly	14
4-2-1. Engine Disassembly	14
4-2-2. Engine Component Disassembly	17
4-2-3. Chaincase Disassembly	18
4-2-4. Carburetor Disassembly	22
4-2-5. Starter Dynamo Disassembly	22
4-3. Washing	23
5. Adjustment Standards	24
5-1. Engine	25
5-2. Transmission	26

5-3.	Carburetor	27
5-4.	Ignition System and Starter Dynamo	28
5-5.	Regulator	29
6.	Reassembly	31
6-1.	Engine Proper Subassembly	31
6-2.	Engine Proper Assembly	32
6-3.	Chaincase Assembly	34
6-4.	Complete Engine Assembly	37
6-5.	Preparations for Trial Operation	40
7.	Trouble Shooting	42
7-1.	Starter	42
7-2.	Dynamo	44
7-3.	Starting Difficulties	46
7-4.	Trouble at Low Speed	47
7-5.	Overheating	47
7-6.	Power Output Drop	47
7-7.	Explosion Outside Cylinder	47
7-8.	Poor Acceleration	48
7-9.	Excessive Vibration	48
7-10.	Abnormal Noises	48

1. GENERAL DATA

The Rabbit Superflow S601B installs the Model ES56 single cylinder, forced air-cooled 2-stroke gasoline engine.

1. It is a high performance engine giving the S601 its maximum speed of 100 kilometers (over 60 miles) per hour, superb acceleration and powerful climbing power.

2. It is a unit swing type engine with the engine and the chain in a sealed oil bath casing forming a single unit. Chain and sprocket life has been made semi-permanent and the noise factor has been drastically reduced.

3. The S601B installs a fluid torque converter for a true completely automatic transmission.

4. A powerful and reliable starter dynamo provides quick and constant press-button starting.

5. Refined body design provides a simple and light construction for simplicity in handling and servicing.

6. Enduring durability and stable reliability are built into the engine through long years of engineering experience and technical know-how.

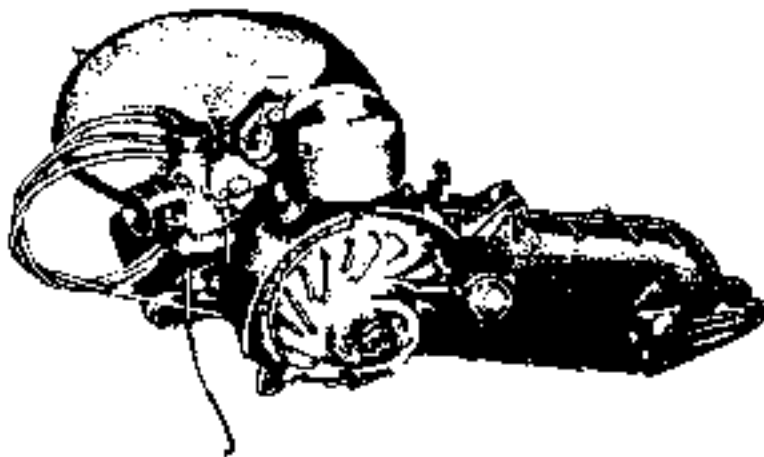

Fig. 1

This engine is a crankcase compression, piston valve type with loop exhaust. The cylinder is angled forward. On the right upper side of the crankshaft is installed the starter dynamo with a sirroco type cooling fan. On the left side is installed the fluid torque converter. On the left side of the crankcase is installed the sealed chaincase. The engine and the crankcase is attached to the body through a common mounting boss on a pivot shaft. The chaincase is included in a single unit that pivots up and down on the pivot shaft. (Unit swing) In the center part of the chaincase is attached the oil damper and at the rear an air spring. The rear wheel is a single side suspension. The carburetor is a monoblock with a starting device. The cylinder is located on the left side and is connected through a rubber duct to the air cleaner which is attached to the scooter frame. The muffler is attached to the front of the cylinder exhaust port and is equipped with two muffling chambers. It is mounted on the engine.

2. ENGINE SPECIFICATIONS

Bore × Stroke	65mm × 60mm (2.6 in × 2.4 in)
Piston Displacement	199-cc (12 cu.in)
Compression Ratio	6.5 to 1
Maximum Horsepower	11 HP at 5,500 rpm
Minimum Fuel Consumption	45 km/li (106 mi/US gal) 2.2 li/100 km
	At a set speed of 40 km/h (25 mph) on a level paved road under windless condition.
Cooling System	Forced Air
Lubrication	Mixed Fuel
Lubricant	2-stroke oil
Fuel	Gasoline 25 to 2-stroke oil 1
Ignition	Battery
Firing Angle	BTDC 5°—26° (Automatic Advancing) Advancing Angle: Start 1,200 rpm Finish 1,500 rpm
Ignition Coil	TU 75
Spark Plug	NGK B6
Starting	Electric Starter
Starter and Charger	SAP 1000
Battery	DC 6 or BR 6-6
Carburetor	PW 24BS Venturi 24 Jet needle 24101-2 stage Main jet 95 Air screw 1 turn return Pilot jet 45 Starter jet 55
Transmission	Fluid Torque Converter Model MS 31
Gear Ratio	Continuous
Reduction Ratio	Primary Chain 2.465 Secondary Chain 1.928 Total Reduction 4.757
Torque Converter Oil	Superflow Torkon Oil 0.8 liter (1.69 pints) or ordinary automobile fluid transmission oil.
Chain Oil	Automobile Oil SAE #30 0.3-0.4 liter (0.64-0.84 pint)
Fuel Tank Capacity	10 liters (2.64 US gal)
Length × Width × Height	651mm × 456.5mm × 400mm (25.6 in × 18.4 in × 15.7 in)
Weight	37.8 kg (83.2 lb) incl. torque converter

2-1. Engine Model and Serial Number

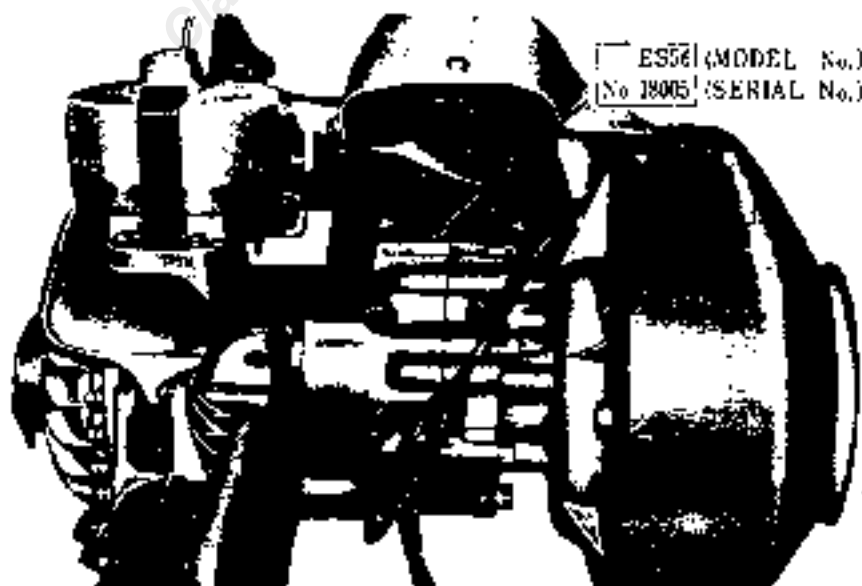
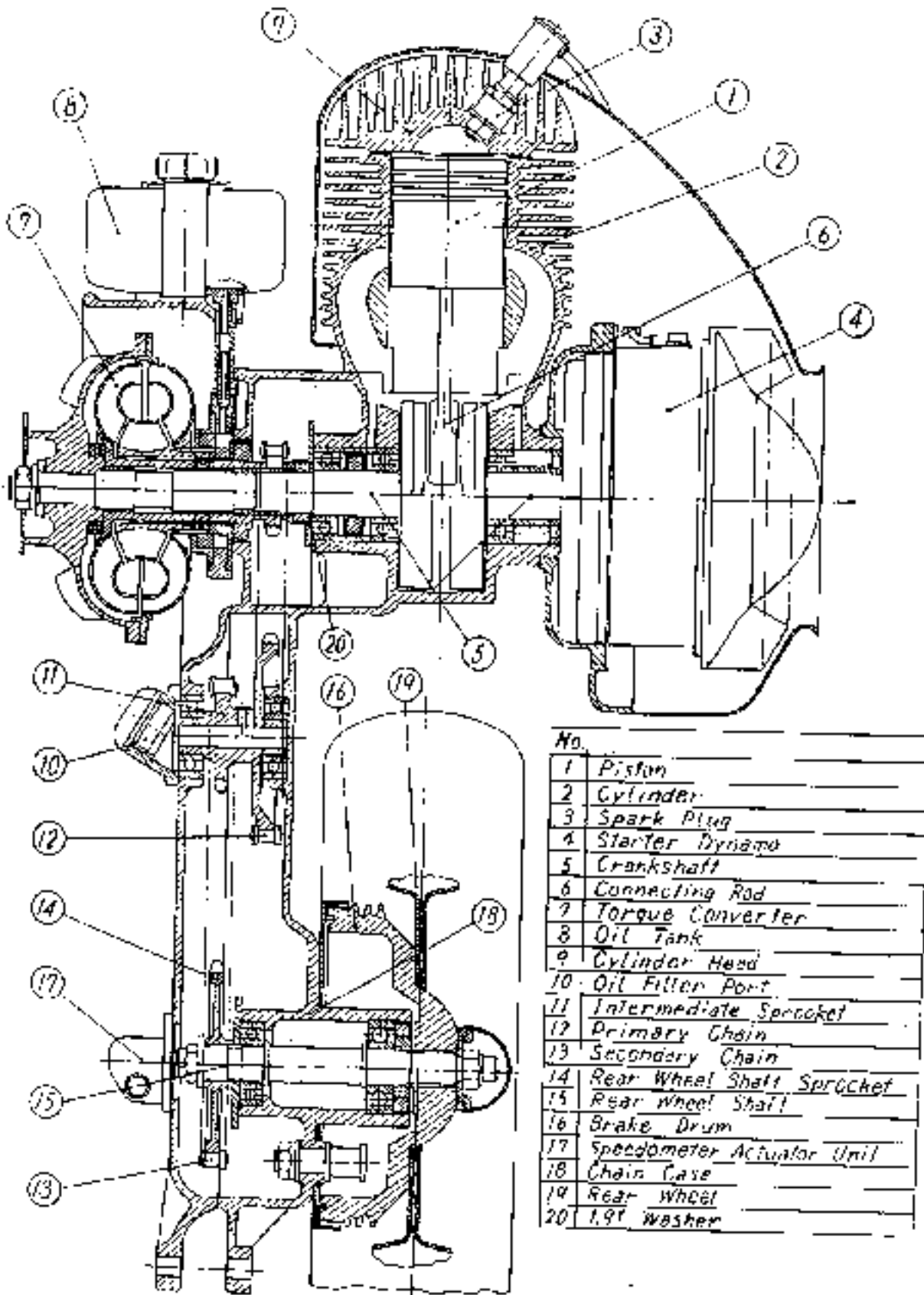

Fig. 2



No.	
1	Piston
2	Cylinder
3	Spark Plug
4	Starter Dynamo
5	Crankshaft
6	Connecting Rod
7	Torque Converter
8	Oil Tank
9	Cylinder Head
10	Oil Filter Port
11	Intermediate Sprocket
12	Primary Chain
13	Secondary Chain
14	Rear Wheel Shaft Sprocket
15	Rear Wheel Shaft
16	Brake Drum
17	Speedometer Actuator Unit
18	Chain Case
19	Rear Wheel
20	1.9T Washer

Fig. 3. Engine and Transmission

3. CONSTRUCTION

3-1. Engine and Transmission System (See Fig. 3)

a) Cylinder

The cylinder is made high wear-resistant special steel casting. When the engine is installed on the scooter, the cylinder cants forward 49 degrees.

b) Cylinder head

The combustion chamber is dome-shaped and offset 10 mm to the rear from the cylinder center line for maximum combustion performance.

c) Piston

Made of light alloy with low thermal expansion, high heat resistance and hardness when run hot.

d) Piston rings

The top ring is provided with hard chrome plating for high wear resistance and has also been wet-plated for easier initial breaking in. The second and third rings are parkerized for easier tuning up operations.

e) Crankshaft and connecting rod

The crankshaft has ends with key ways for torque converter and rotor. The crankpin is force-fitted into the crankwebs and the connecting rod big end is mated therewith through double rows of needle roller in a cage. The small end is mated with the piston pin through a bronze bushing.

f) Crankcase and main bearing

The crankcase is divided into two pieces. Each piece holds two sets of ball bearing which are lubricated by the oil in the fuel mixture sucked into the pre-compression chamber. The crankcase mounting boss is located in the front. It is a single unit with the chain case.

g) Transmission

The engine drives the rear wheel through the fluid torque converter, the primary bushed chain and the secondary roller chain. The fluid torque converter is attached on the left side of the crankshaft.

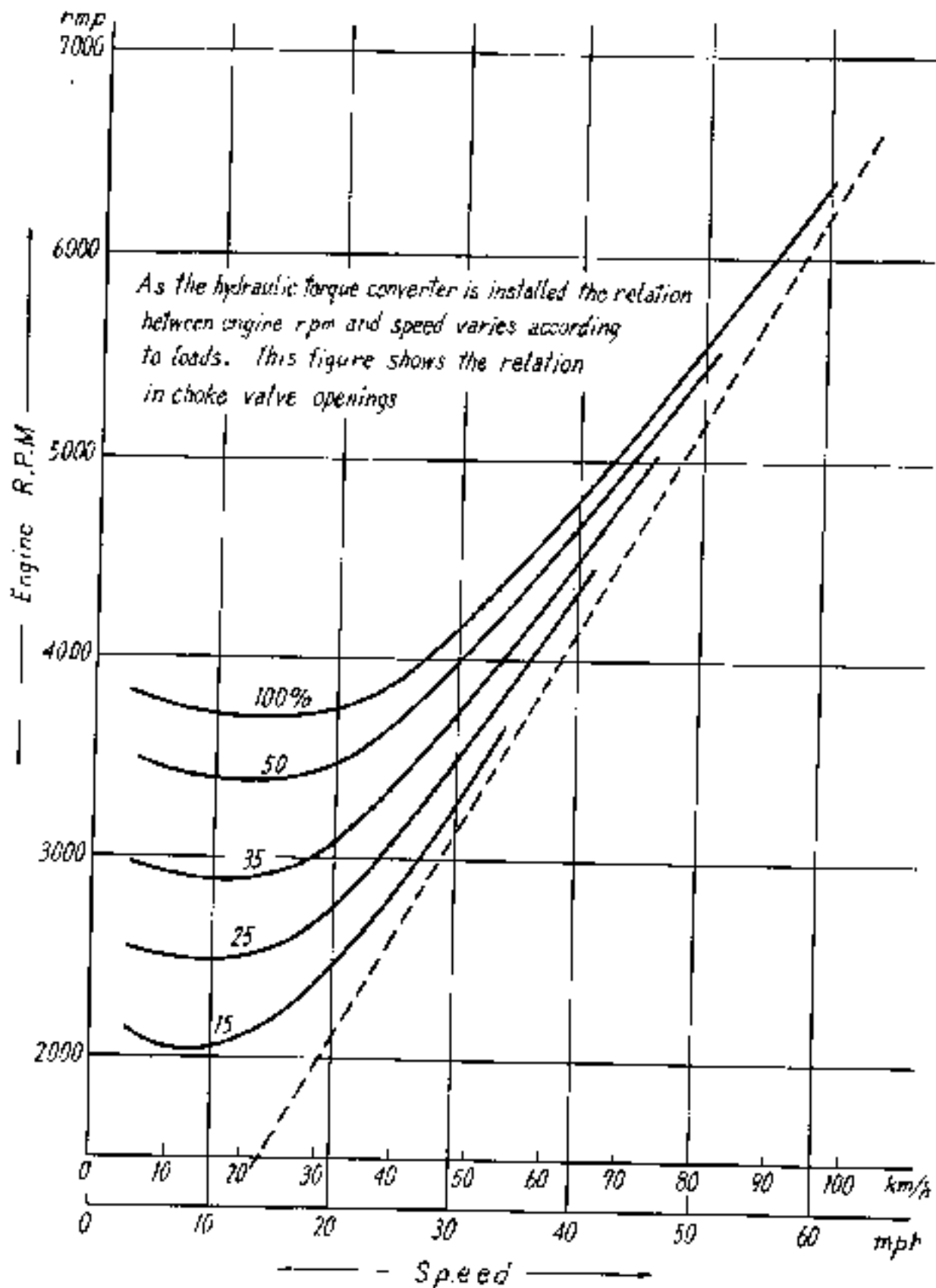

Fig. 3-1. Speed and engine r.p.m.

3-2. Ignition System

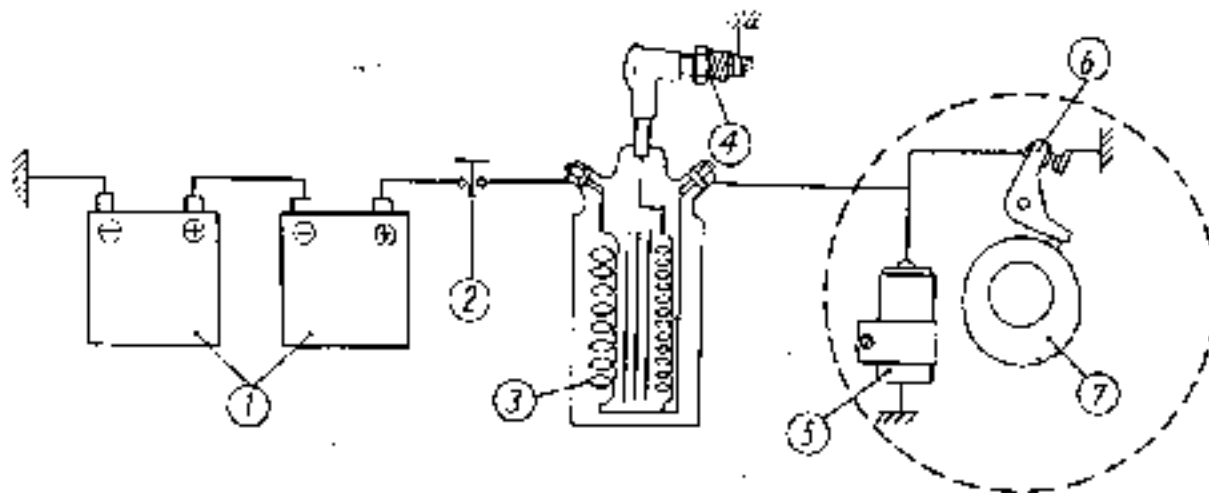

Fig. 4. Ignition System

1. Battery 2. Main Switch 3. Ignition coil 4. Spark plug 5. Condenser
6. Breaker 7. Rotor cam

Ignition Timing BTDC 5° ~ 25° (Automatic Advance)

Start 5° Finish 25° Battery 6V BAH 2ea Spark plug NGK-B-6

Gap 0.5 mm~0.6 mm (0.02"~0.023")

Contact Breaker Point Gap 0.35 mm (0.014")

3-3. Lubrication

1. The piston, cylinder, piston pin, connecting rod, crankshaft main bearings (Fig. 5 (a), (b), (c)) are lubricated by the oil in the fuel mixture.

2. The chain, chaincase internal bearings (sprocket and rear wheel shaft bearings) and a part of the main bearing (Fig. 5 (d)) are lubricated by the chaincase oil bath.

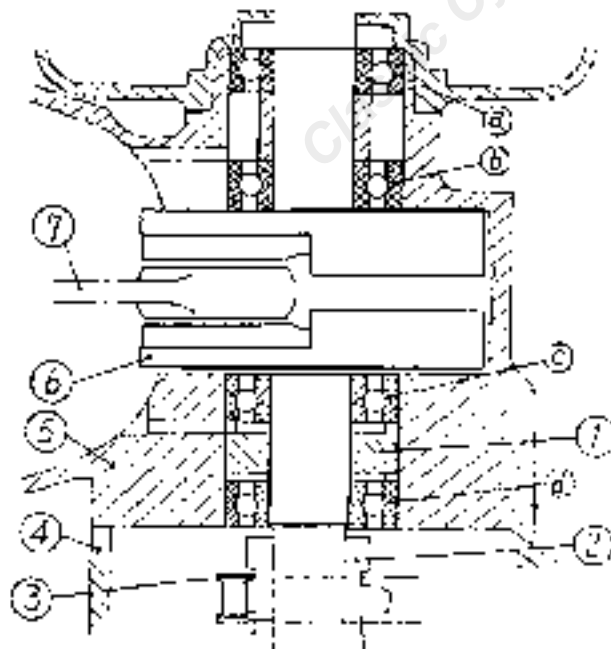

(a), (b), (c), (d) Main bearings

1. Oil seal
2. Sprocket
3. Primary chain
4. Chaincase
5. Crankcase
6. Crankshaft
7. Connecting rod

3. Bearing (c) and (b) are segregated by the oil seal (1) and constitutes a separate lubrication system.

4. Gasoline and 2-stroke motor oil are mixed in the following ratios:

Up to 1000 km (600 miles) 20:1

After 1000 km (600 miles) 25:1

3-4. Carburetor

The float chamber is of the double float type and located in the center of the venturi for high anti-vibration characteristic and stable angular performance on lilly roads. It has a cable operated starting device for simple starting. It permits operation in cold weather without warming up.

A. Construction

i) Carburetor (see Fig. 6-1 and Fig. 6-2)

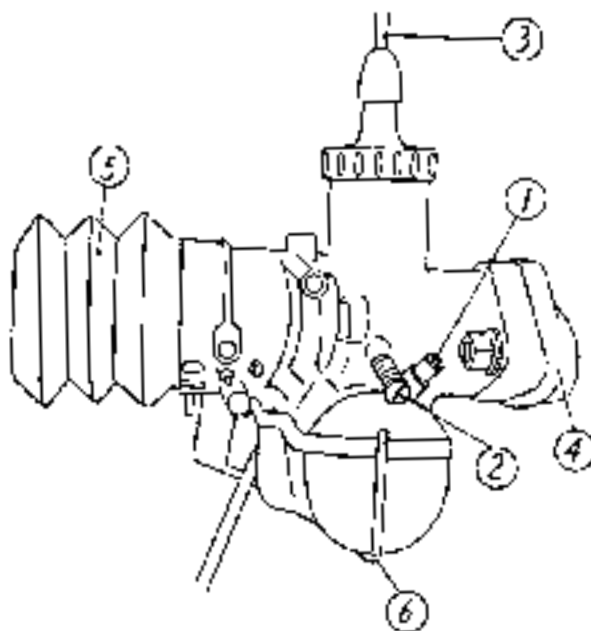

Fig. 6-1.

1. Air screw
2. Idle adjusting screw
3. Throttle cable
4. Intake pipe
5. Rubber duct
6. Float chamber clip

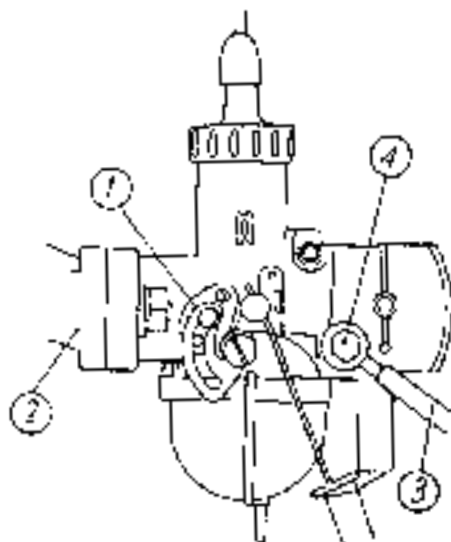

Fig. 6-2.

1. Starting device
2. Intake pipe
3. Fuel pipe
4. Banjo bolt

ii) Carburetor Internal Construction (see Fig. 6-3)

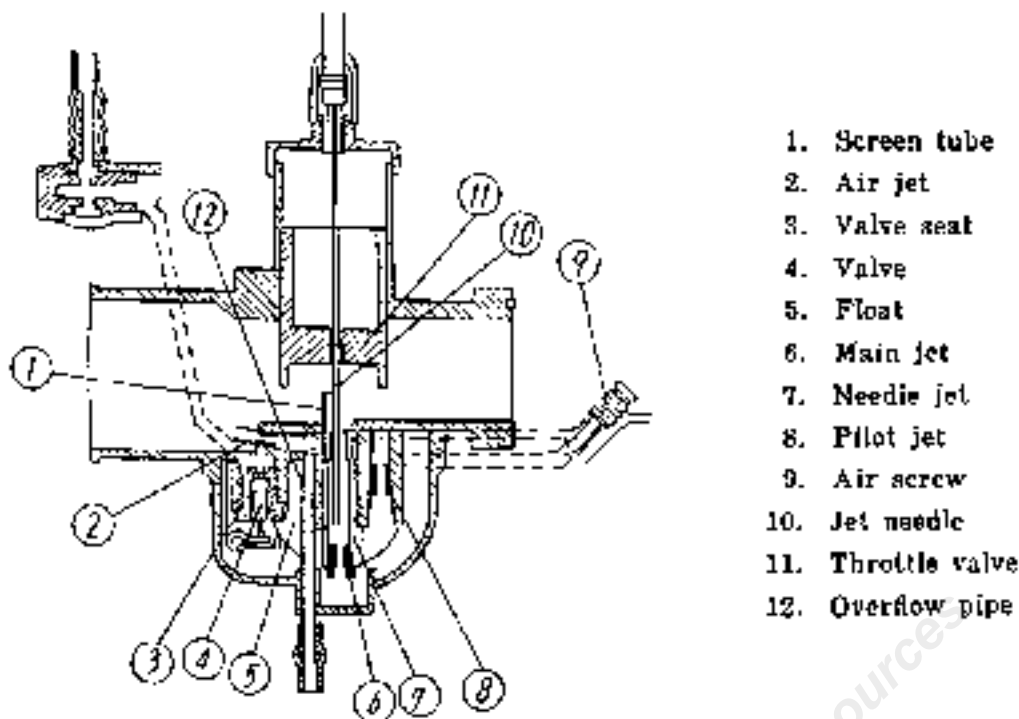

Fig. 6-3. Cross-section

iii) Starting Device

The usual choke and tickler system has been replaced with a starting device which greatly simplifies the starting operation eliminating the troublesome choke manipulation.

Fig. 6-4 shows the construction. The valve is normally closed. When the choke knob is pulled, the valve opens and engine suction inducts fuel from the starter jet and air from the air intake into the mixing chamber. This provides a rich mixture for starting. The knob is pushed back in after starting for normal operation.

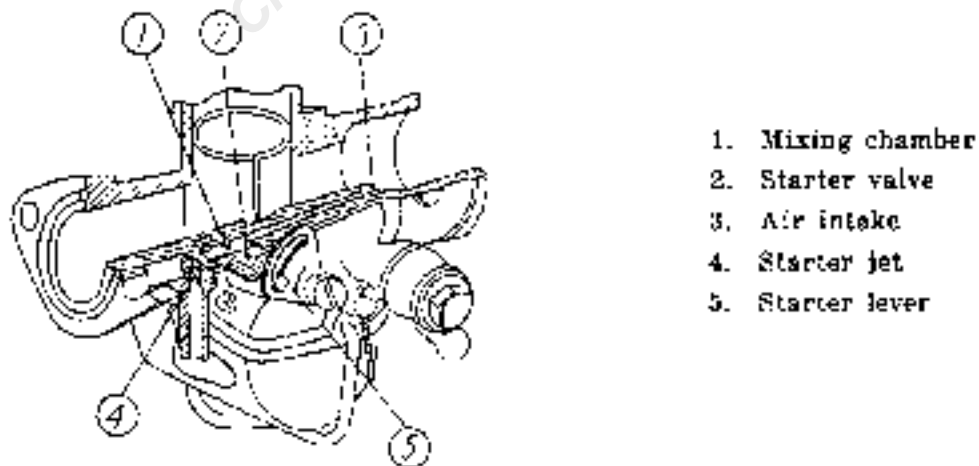

Fig. 6 4. Starting device

B. Specification

Type	PW24BS	Jet Needle	24101-2nd stage
Diameter	24	Throttle Valve	4.0
Main Jet	85	Pilot Jet	145
Air Jet	1.0	Air Screw	1
Needle Jet	2.6	Starter Jet	

C. Handling and Adjustment

- i) Idle adjusting screw (see Fig. 6-1)

Turn to the right for raising and to the left for lowering the engine rpm.

- ii) Air screw (see Fig. 6-1)

Turn to the right for richer and to the left for leaner fuel. The standard setting is one turn back from the fully closed position. Adjust slightly rich in winter and slightly lean in summer.

- iii) Jet needle

The jet needle is provided with 5 grooves which are counted from the top. Normal setting is the 2nd stage. The fuel becomes leaner when moved upward and richer downward. The jet needle is fixed at the desired position with the needle clip.

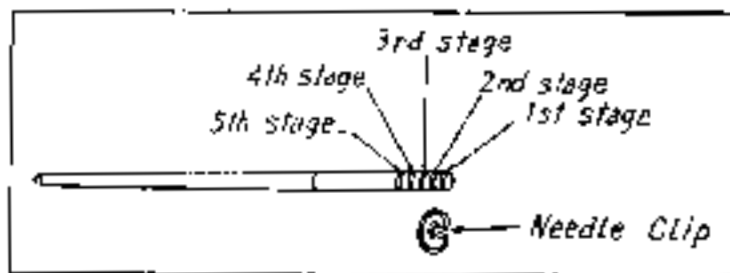

Fig. 7. Jet Needle

- iv) Main jet adjustment for altitude

Adjust in accordance with the following table for operation at different altitudes. (Main jet, pilot jet, jet needle, air screw—see Fig. 6-3)

Altitude	1000 m (3280 ft)	2000 m (6560 ft)	3,000 m (18120 ft)
Main Jet	85~88	82	78
Jet Needle	—	24101-1st stage	24101-1st stage
Pilot Jet	—	—	40
Air Screw	—	1 3/4	1 2/4

3-5. Electrical Components

The S601B is a battery ignition scooter using a starter dynamo for starting and charging.

The starter dynamo is the inner ring revolving type with an automatic advancing device on the tip of the rotor (armature) equipped with a sirocco type cooling fan.

The regulator incorporates three functions, starter magnetic switch for starting, cut-out relay for opening and closing the charging circuit, and voltage regulator for adjusting the charging voltage.

Specifications

ITEM	TYPE	PERFORMANCE
Starter Dynamo	SAP 1000 or BA 12	Starter: 12 V 0.4 HP 30 seconds Dynamo: 13.5 V Over 10 A (1600—7000 rpm)
Regulator	ARF H 1000 E	Cut-in Voltage/rpm 13.5±0.5 V/under 1300 rpm No-load Voltage 16.3±0.5 V (1600—7000 rpm) Resistor Load Voltage/Current 13.5 V/10—12.5 A (1600—7000 rpm)
Ignition Coil	TU 75	Sparking Capacity (Three Point Gap) 300 rpm Approx. 8 V Over 7 mm 7000 rpm Approx. 12 V Over 8 mm
Battery	BR 6-6 or DC 6	Super High-Charge Dry Charge Battery 6 V 13 AH 2ea in series

3-6. Spark Plug

The NGK B-6 spark plug with a gap of 0.5-0.6 mm (0.02-0.023 in) has the proper heat value and is the standard part. It is a high performance spark plug with a wide range of heat values. If this item is not available, select an appropriate alternate from the following chart.

Heat Range	NGK	CHAMPION	AC	AUTO-PINE	BOSCH
Hot	B-6	J-8	41, 45-6	AT8, A-5 AR-5, 4S165 AR-51	W175T4
			44-5 Com.		
46E					
Cold		J-7	44-Com.	AT-6, AN-5 AR-41	W175T4
			43R-Com.		
			43-5 Com.		
Cold	J-6	48-5, 43-5R	AR-4, AT-4	W225T3	
		48-Com.			
Cold	J-5	43, 42.5 Com.	A3, 4S 250	W240T3	
		42, 42 Com.			

3-7. Operating Principle of Starter Dynamo (See Fig. 8)

Process	Current	Charge Light	Starter Magnetic Switch	Starter Dynamo	Engine
Main Switch ON	Blue Route from Battery	On	Not Operating Starter Switch Off	Dead	Dead
Starter Button PUSHED	Red Route from Battery	Off	Operating (1) Current thru electric magnet (2) Moving piece contacting (3) Starter point closed	Operate as Starter	Start
Starter Button RELEASED	Yellow Route from Battery and Dynamo	On	Not Operating (1) Moving piece released (2) Starting point open	Operate as Dynamo	Running

3-8. Regulator

The regulator is provided with two different charging terminals. The operating and charge conditions determines which terminal is to be used.

1) High Charge Terminal

This is used where low speed and frequent stops, such as in busy city traffic, tends to cause the battery to over-discharge.

2) Low Charge Terminal

This is used when the scooter is operated at high speeds such as in the country and when over-charging tends to occur.

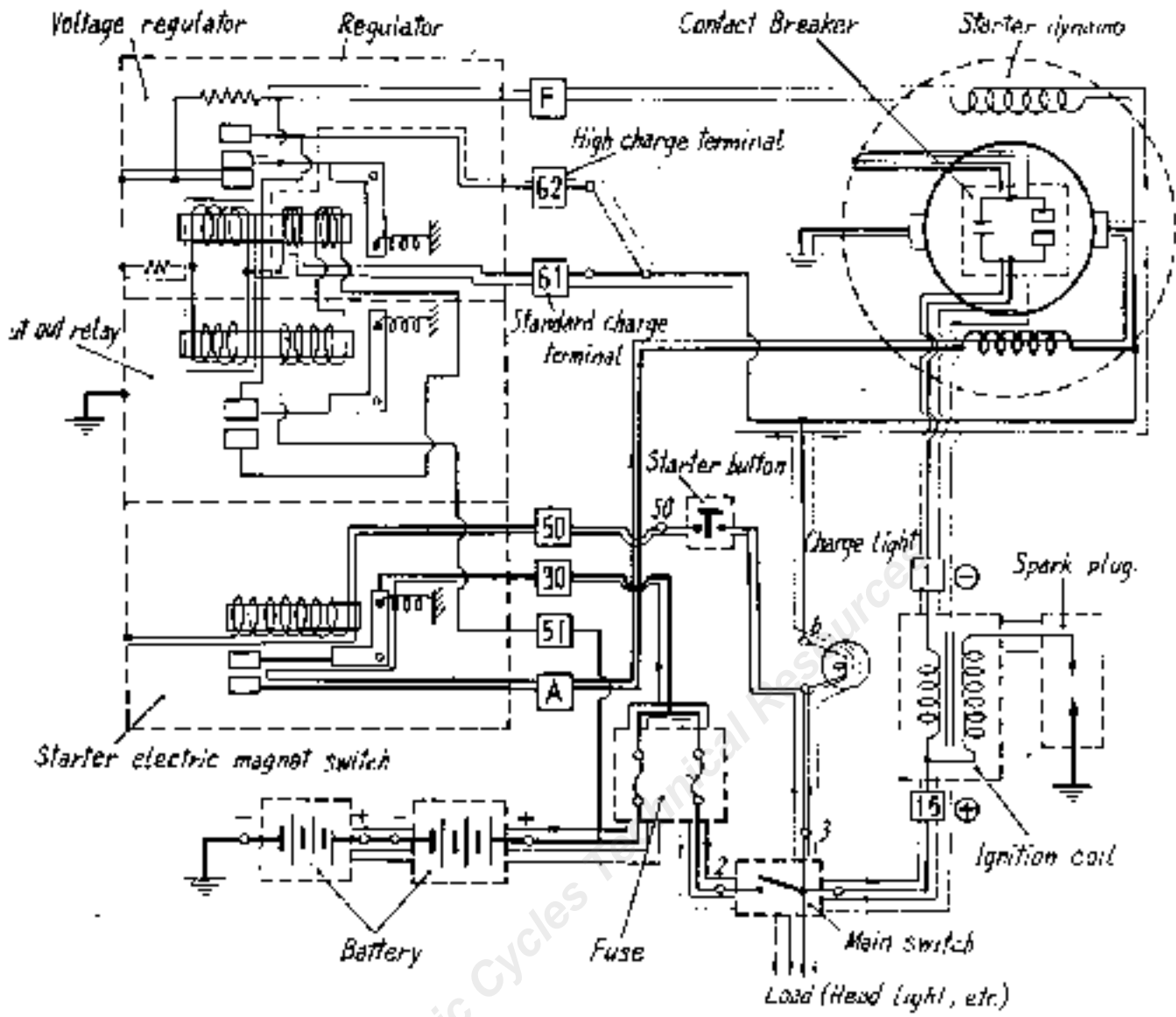

Fig. 8. Electric Wiring Diagram

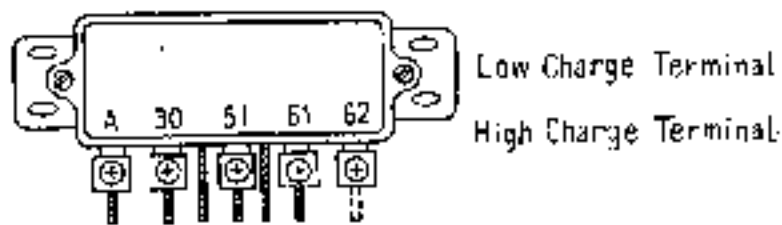

Fig. 9. Regulator

4. DISASSEMBLY AND CLEANING

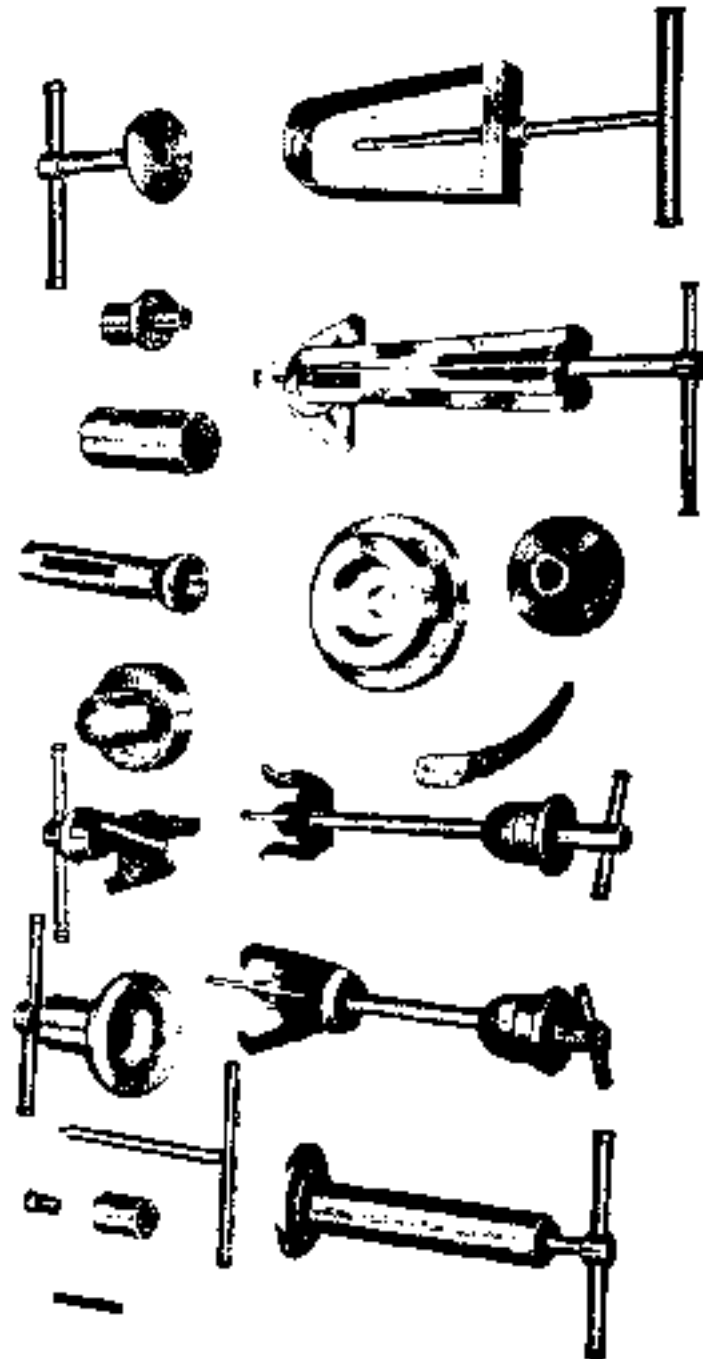

Fig. 10. Special Tool

4-1. Special Tools





Tool Number	Nomenclature	Application	Fig. No.
Y-72-62	Force-fitting Tool	Crankcase Sub-assy (left)	a
Y-72-63	ditto	Crankcase Sub-assy (right)	b
Y-72-68	ditto	Installing rear wheel shaft, bearing retainer, oil-seal, etc. to right chaincase	c
Y-72-73/1	ditto	Installing bearing retainer, oil-seal and spacer to left and right crankcase	d
Y-72-74	ditto	(a) Retainer plate for crankcase sub-assy (b) Retainer plate for force-fitting bearing into right crankcase	e
Y-78-236	Hex-nut Spanner	Intake pipe and cylinder head	f
Y-79-468/1	Extractor	Torque converter	g
Y-79-703	ditto	Left Chaincase	h
Y-79-704	ditto	(a) Intermediate sprocket (b) Bearing retainer from intermediate sprocket	i
Y-79-707	ditto	Right crankcase	j
Y-79-708	ditto	Bearing retainer from crankshaft	k
Y-79-711	ditto	Bearing retainer from right chain-case intermediate sprocket	l
Y-79-712	ditto	Bearing retainer from intermediate sprocket	m
Y-79-717	Disassembly Tool	Piston pin	n
Y-79-726	Extractor	Left crankcase	o
Y-79-660	Reassembly Tool	Spacer for installing starter dynamo and armature	p
Y-79-669	Disassembly Rod	Armature extraction	q
Y-79-670	Disassembly Bolt	Fan extraction	r
Y-79-748	Force-fitting and Disassembly Tool	Piston pin and bushing	s



4-2. Disassembly

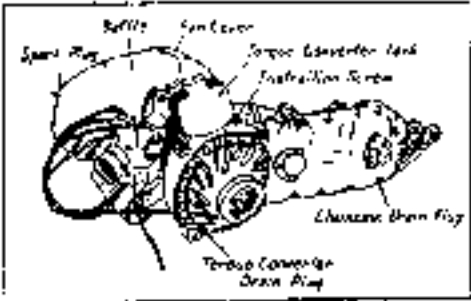

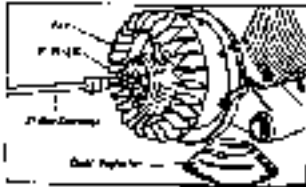
Written data on the condition of the disassembled parts and measurements thereon should prove valuable reference material for subsequent disassembly.

4-2-1. Engine Disassembly

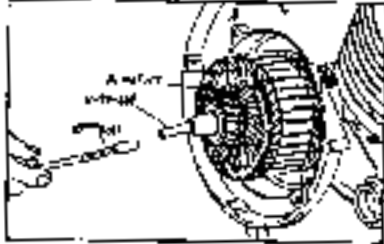
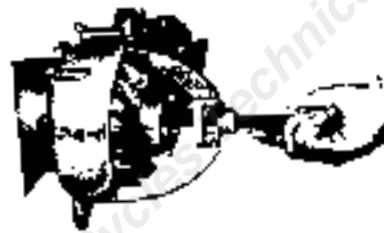
SEQ	FIG	PROCESS	PROCEDURE	CAUTION	TOOL
1		Drainage of torque converter fluid	Remove the torque converter drain plug.		
2		Drainage of chain-case oil	Remove the chaincase drain plug.		

SEQ	FIG	PROCESS	PROCEDURE	CAUTION	TOOL
3	11	Torque converter tank	<p>(a) Remove installation screws.</p>  <p>Fig. 11</p> <p>(b) Loosen the clip on the rubber hose and pull tank upward to remove.</p>	Remove tank with base.	
4	12	Carburetor	<p>Remove the installation bolt of the intake pipe with carburetor attached.</p>  <p>Fig. 12</p>	The bolt is an internal wrenching hex bolt.	Y-78-286
5		Spark plug	<p>(a) Remove the rubber packing.</p> <p>(b) Remove the spark plug.</p>		
6		Fan Cover	<p>(a) Remove the baffle.</p> <p>(b) Remove the fan cover.</p>		
7	13	Starter Dynamo	<p>(a) Remove the dust protector.</p> <p>(b) Remove 10 mm bolt holding fan to crankshaft.</p> <p>(c) Insert the disassembly bolt into the 14 mm hole in the fan and screw in to remove fan.</p>  <p>Fig. 13</p>	Fan is taper-fitted to the armature shaft. Do not drop the woodruff key.	Y-78-670
	14		<p>(d) Remove carbon brush. Pry up the spring holding the stator carbon brush with a screw-driver, pull the brush into the holder and separate it from the armature commutator pushing the side of the brush.</p>  <p>Fig. 14</p>	Always pull up the carbon brush when removing or installing stator.	

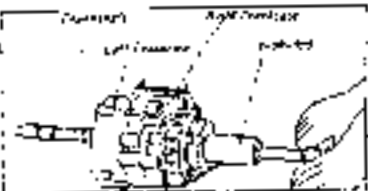
SEQ	FIG	PROCESS	PROCEDURE	CAUTION	TOOL
7	15	Starter Dynamo	<p>(e) Pull out the lead wire.</p> <p>(f) Remove four screws holding the stator and pull out carefully.</p> <p>(g) Remove armature. Insert disassembly rod into armature hole. Screw in 10 mm bolt removed in (b) to remove armature.</p>  <p>Fig. 15</p>	Armature is tapered to the crankshaft.	Y-79-669
8	16	Torque converter	<p>(a) Remove the 14 mm nut at crankshaft tip.</p> <p>(b) Attach the 3 prongs of the extractor on the flange of the impeller casing and place the tip of the center rod on the head of the crankshaft. Turn the handle to remove torque converter.</p>  <p>Fig. 16</p>		Y-79-468/L
9	2	Chaincase	<p>(a) Remove the installation bolts.</p> <p>(b) Tap lightly with a wooden mallet and pull out chaincase.</p>		
10			<p>(a) Remove the starter dynamo woodruff key on the crankshaft.</p> <p>(b) Remove the installation bolt.</p> <p>(c) Pull out tapping lightly with a wooden mallet</p>	It can be removed with the key installed but care must be taken not to injure the oil seal	
11	17	Cylinder	<p>(a) Remove the cylinder head</p>  <p>Fig. 17</p> <p>(b) Remove the cylinder.</p>		
12		Piston	<p>(a) Remove circlips from both ends of piston pin.</p>		

SEQ	FIG	PROCESS	PROCEDURE	CAUTION	TOOL
12	18	Piston	<p>(b) Push out piston pin to one side.</p>  <p>Fig. 18</p>		Y-79-717
13	19	Crankcase	<p>(a) Remove the right and left crankcase bolt.</p> <p>(b) Attach the extractor with the three bolts to the stator base. Place the tip of the rod on the crankshaft head and turn the handle to remove the right crankcase.</p>  <p>Fig. 19</p>		Y-79-707
14	20	Crankcase, left	<p>(a) Remove bearing retainer plate.</p> <p>(b) Fix the extractor in the retainer plate screw holes and remove in the same manner as the right crankcase.</p>  <p>Fig. 20</p>		Y-79-726



4-2-2. Engine Component Disassembly

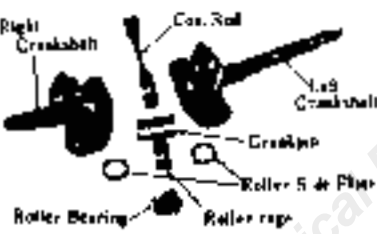

SEQ	FIG	PROCESS	PROCEDURE	CAUTION	TOOL
I	21	Crankcase, right and left	<p>Tap out bearing and spacer. Place crankcase with contact side on bottom on retainer plate. Place force-fitting tool on bearing surface and tap out bearing and spacer.</p>  <p>Fig. 21</p>	In some cases, bearing and spacer may stick to crankshaft. In this case, refer to section on crankshaft.	Y-72-74 Y-72-73/1

SEQ	FIG	PROCESS	PROCEDURE	CAUTION	TOOL
	22		<p>(a) When bearing and spacer stick to crankshaft, hook the three prongs of the extractor between the crank web and bearing. Screw in and fix in place. Place the rod tip on the crankshaft head and screw in to extract bearing and spacer.</p> 		Y-79-708
2		Crankshaft	<p>Fig. 22</p> <p>(b) Extract crankpin.</p> <p>(c) Remove connecting rod, roller race, roller bearing and roller side plate.</p> 		
	23		<p>Fig. 23</p>		

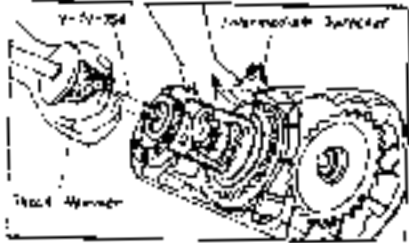
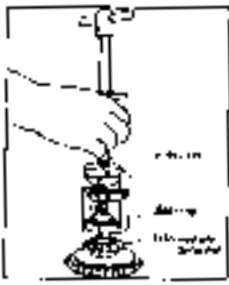
4-2-3. Chaincase Disassembly

SEQ	FIG	PROCESS	PROCEDURE	CAUTION	TOOL
1	24	Chaincase, right and left	<p>(a) Remove dust protector cover.</p> <p>(b) Remove free wheel.</p> <p>(c) Remove oil filler port.</p> <p>(d) Remove speedometer drive unit.</p> <p>(e) Remove oil check bolt.</p> <p>(f) Remove chaincase installation bolt.</p> <p>(g) Attach extractor to oil filler port. Place the rod on the head of the intermediate sprocket shaft and turn handle to disassemble chaincase.</p> 		Y-79-703
			<p>Fig. 24</p>		

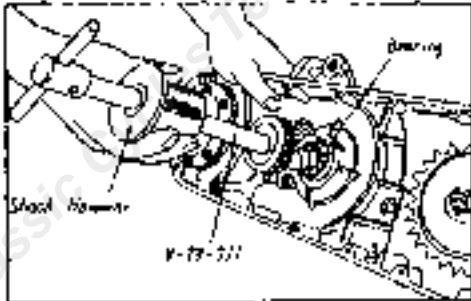
SEQ	FIG	PROCESS	PROCEDURE	CAUTION	TOOL
2	25	Chain	<p>(a) Remove connector on secondary chain and remove chain.</p>  <p>Fig. 25</p> <p>(b) Remove connector on primary chain and remove chain.</p>		
	26		<p>(a) Hook the extractor prongs on the secondary sprocket and fix in place. Push the shock hammer up and apply shocks to extract intermediate sprocket.</p>  <p>Fig. 26</p>		Y-79-704
3		Intermediate sprocket	<p>(b) When the left chaincase is removed or the intermediate sprocket extracted and the bearing sticks to the intermediate sprocket, hook the prongs of the extractor on the bearing and place the rod tip on the intermediate sprocket shaft. Tighten in the rod to remove bearing.</p>  <p>Fig. 27</p>	When the bearing stays in chaincase, see SEQ 6.	Y-79-712
4	28	Rear Wheel Shaft	<p>(a) Remove nut holding rear wheel shaft sprocket.</p>  <p>Fig. 28</p>		

SEQ	FIG	PROCESS	PROCEDURE	CAUTION	TOOL
4	29	Rear Wheel Shaft	<p>(b) Remove sprocket.</p> <p>(c) Remove bearing retainer.</p> <p>(d) Tap wheel shaft from tire side and remove sprocket side bearing.</p> <p>(e) Remove the bearing from rear wheel shaft.</p> <p>(f) Tap shaft from sprocket side to remove oil seal, bushing and bearing from tire side.</p>  <p>Fig. 29</p> <p>(g) Remove bearing and bushing from rear wheel.</p>	Ref: 3-(b)	
5		Brake Stop Shaft	Remove nut and extract shaft.		
6	30	Intermediate Sprocket Bearing	<p>(a) Hook extractor prongs on inner side of right chaincase bearing, tighten rod to fix extractor in place and use shock hammer to extract.</p>  <p>Fig. 30</p>	When bearing remains on chaincase side.	Y-79-711
	31		<p>(b) On left chaincase bearing, use force fitting tool and tap out from inner side of chaincase.</p>  <p>Fig. 31</p>		Y-72-73/1

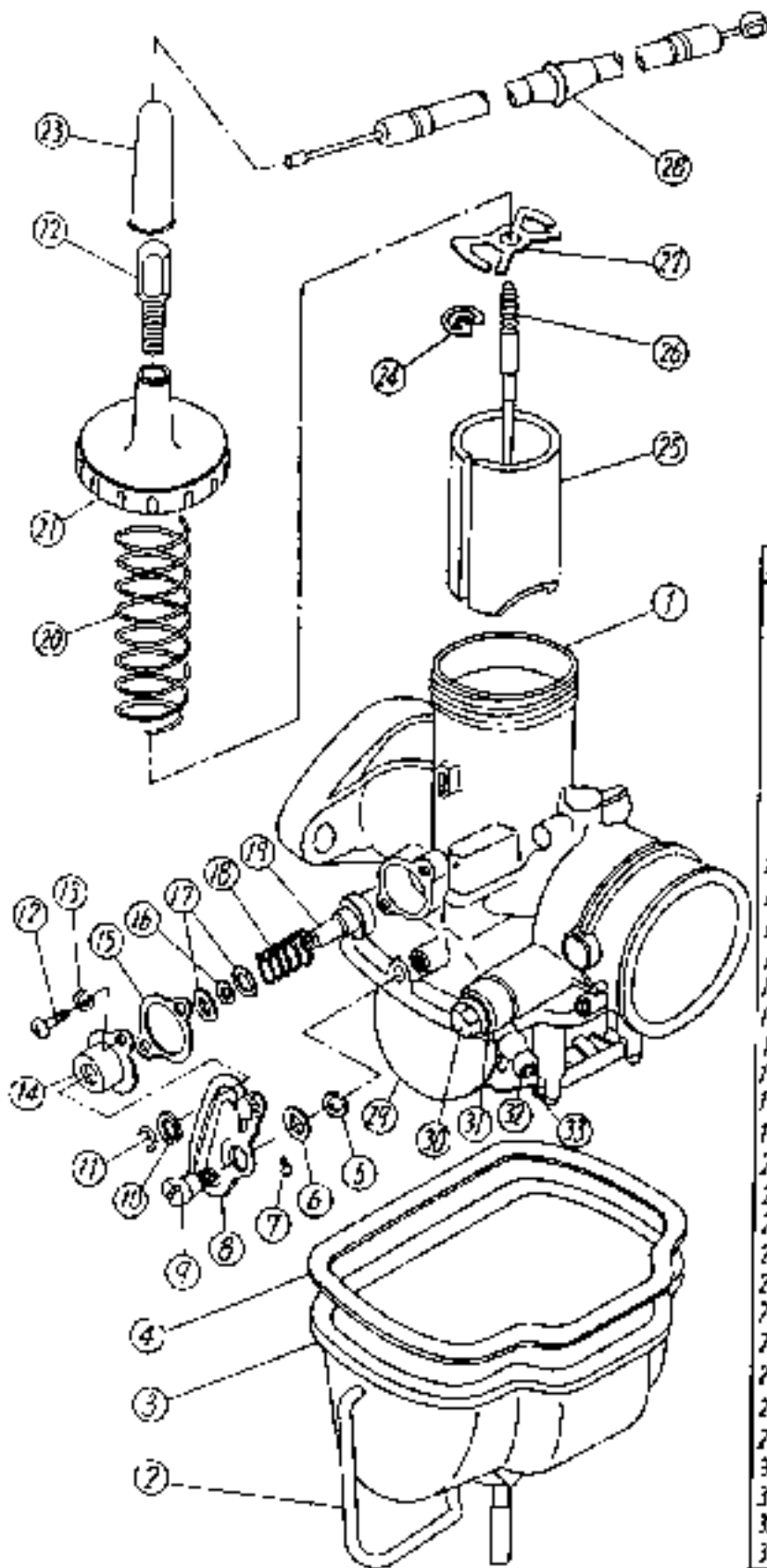

No.	Carburetor Parts	
1	Body	PW24BS1/01
2	Float chamber clip	PW22/68
3	Float chamber	PW22/190
4	Float chamber washer	PW22/55
5	4.5# spring washer	45W32
6	4# polished washer	4WM
7	4#x6 plus screw	4PN6
8	Starter lever	PW24BS/171
9	Starter lever pin	PW24BS/173
10	3# polished washer	3WM
11	2.5# stop ring	23SR1
12	3#x5 plus screw	3PN5
13	3# spring washer	3WS2
14	Starter cover	PW24BS/170
15	Starter cover packing	PW24BS/168
16	O' ring	45R
17	4.5# washer	45WR
18	Starter spring	PW24BS/161
19	Starter valve	PW24BS/165
20	Throttle spring	PW22/71
21	Cap	PW24BS/30
22	Cable adjuster	PW24BS/36
23	Cable cap	PW24BS/78
24	Needle clip	DP13/73
25	Throttle valve	PW24/SR20
26	Jet needle	PW24CH/24
27	Needle clip plate	PW22/72
28	Throttle cable	E556A-031/1
29	Float	PW22/57
30	Banjo bolt	PW22/70
31	10# fiber washer	10WF
32	Banjo	PW22/72
33	Float arm pin	PW22/55

4-2-4. Carburetor Disassembly

SEQ	FIC	PART	PROCEDURE	CAUTION
1		Intake pipe	Remove two 6mm nuts	
2	32	Jet needle	<ul style="list-style-type: none"> a) Remove mixing chamber cap and pull out throttle cable. This will expose throttle valve and jet needle. b) Compress throttle valve spring and remove throttle cable from throttle valve. c) When the jet needle is pushed upward, the spring seat with throttle valve will become loose. d) Remove needle clip from jet needle. 	Spring seat will jump when loosened.
3	6-1	Idle adjusting screw, Air screw	Use screw driver and remove.	
4	32	Starter device	<ul style="list-style-type: none"> a) Remove clip holding starter valve to starter lever. b) Remove starter lever pin. c) Remove 3mm screw on starter cover and remove starter cover, packing, O-ring, washer, starter spring and starter valve. 	
5	6-3 6-4	Jets	<ul style="list-style-type: none"> a) Remove float chamber set clip and free lower part of float chamber body. b) Use screw driver and remove main jet, pilot jet and starter jet. c) Remove needle jet with spanner. 	
6	32	Float, Float valve, Valve seat	<ul style="list-style-type: none"> a) Pull out float arm pin and remove float and float valve. b) Remove valve seat with spanner. 	
7	32	Banjo	Remove banjo bolt to free banjo.	

4-2-5. Starter Dynamo Disassembly

SEQ	FIC	PART	PROCEDURE	CAUTION
1	33	Carbon brush	<ul style="list-style-type: none"> a) Refer to 4-2-1. 7.(d). b) Remove screw and pull out carbon brush. 	
2	33	Contact breaker	<ul style="list-style-type: none"> a) Remove contact arm spring nut. b) Remove arm stopper and contact arm. c) Remove A-terminal bolt. d) Remove contact adjusting plate bolt. 	

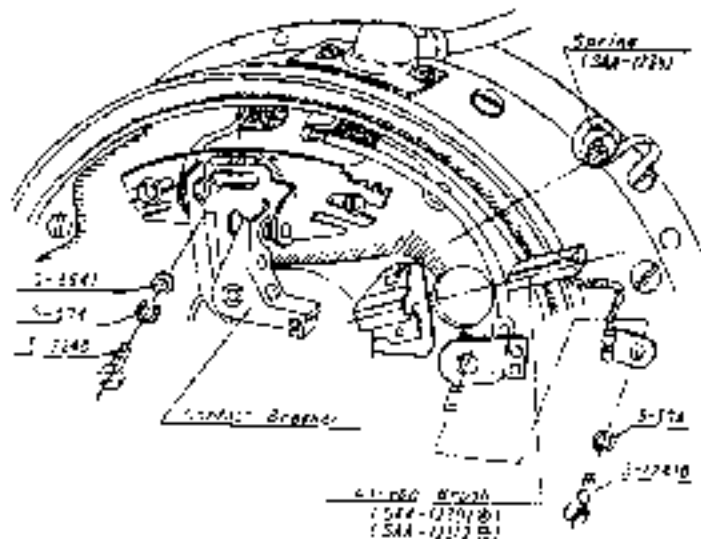

Fig. 33

4-3. Washing

The disassembled parts should be carefully washed in cleaning fluid, preferably kerosene. Washing is conducted in two stages; the first stage for overall cleaning and the second stage with clean fluid for finishing. After washing, the parts should be further cleaned with compressed air. Watch for metal particles when washing. They can be indications of trouble.

CAUTIONS WHEN WASHING

- (a) Old cleaning fluid may be used for overall cleaning. When you do, let it stand for at least 24 hours to let the sediments settle and use only the clean upper part. For the finishing wash, always use new fluid.
- (b) Clean out oil holes and small corners thoroughly with compressed air.
- (c) On functional components such as carburetor, use cleaning rag dipped in kerosene for outside. Do not allow fluid to get inside.
- (d) Do not use cleaning fluid on rubber and other non-metallic parts.
- (e) Do not use dirty cleaning fluid on precision parts such as bearings, piston, carburetor and connecting rod.
- (f) When parts are to be left disassembled for a while, apply a light coating of engine oil to prevent corrosion and store in a clean dust-free location.

5. ADJUSTMENT STANDARDS

Adjustment Standards are contained in the following drawings.

Abbreviation

- D: Fitted Inner Diameter
- d: Fitted Outer Diameter
- T: Tightness
- L: Loose
- G.W: Groove Width
- R.T: Ring Thickness
- S.G: Side Gap

Numerals:

Ex.	Unit	mm
D	Unit	inch

Classic Cycles Technical Resources

5-1. Engine

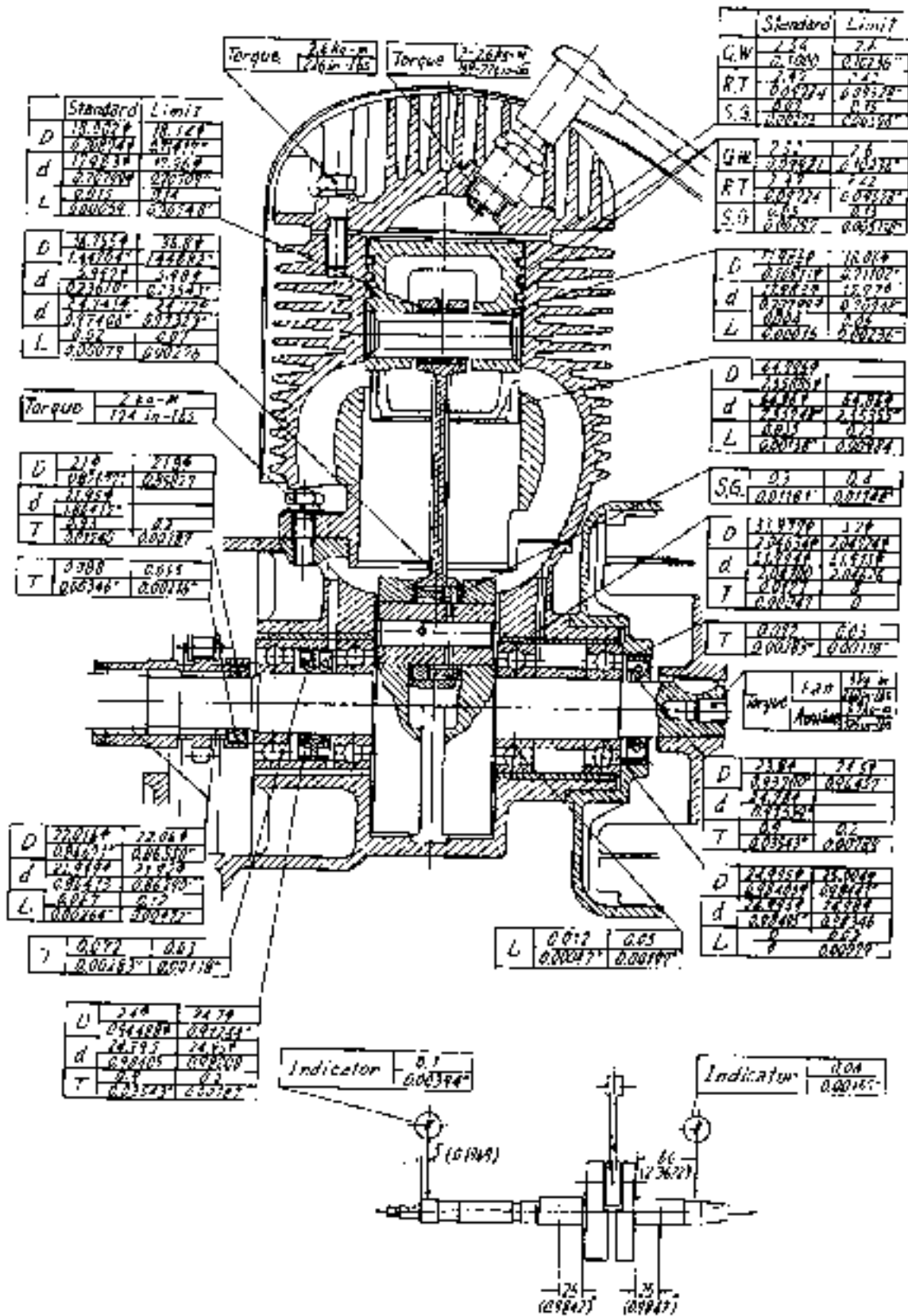

Assembly Accuracy of Crank-Shaft
Fig. 34u

5-2. Transmission

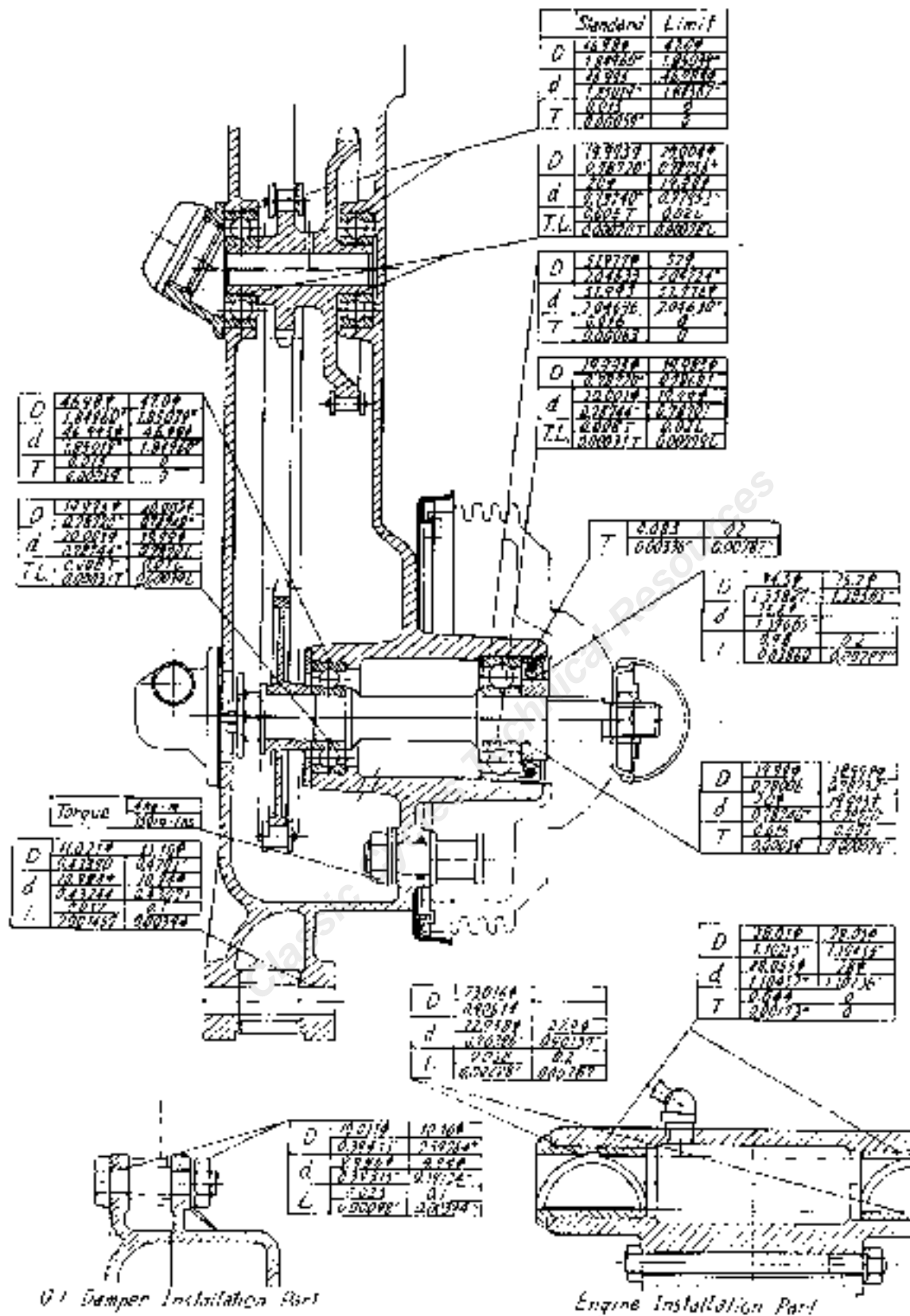

Fig. 34 b

5-3. Carburetor

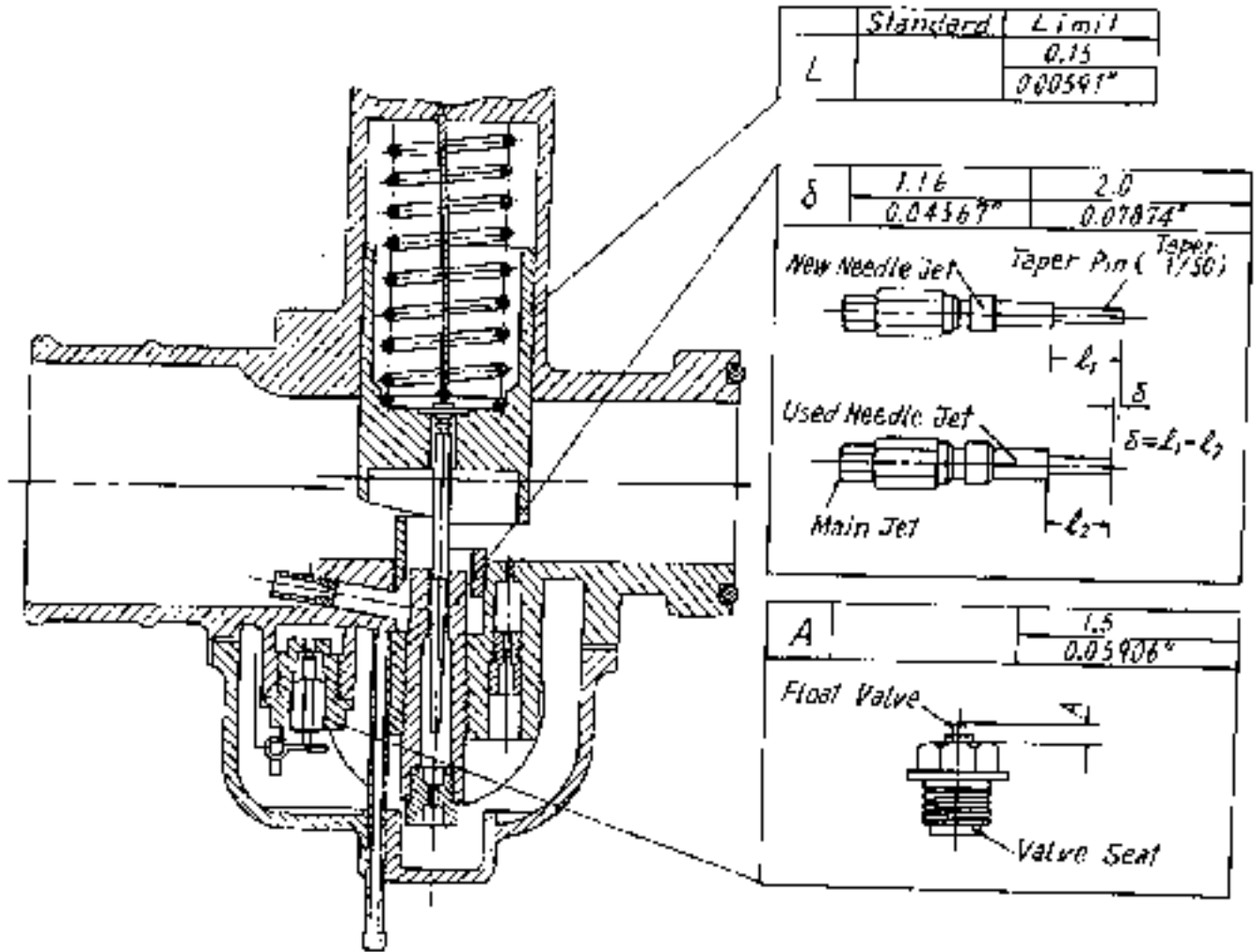

Fig. 34c

5-4. Ignition System and Starter Dynamo

Check Point	Measurement		Adjustment		Remarks
	Process	Tools	Limit	Standard	
① Contact breaker point gap	Measure gap when point is open	Feeler gage	0.25 mm (0.0098 in)	0.35 mm (0.0138 in)	Adjust 0.3-0.4 mm (0.0118~0.0157 in). Correct burnt surface with emery paper or oilstone.
② Carbon brush	Measure length	Scale	16 mm (0.630 in)	22 mm (0.866 in)	Always use genuine replacement parts
③ Carbon brush retainer spring	Measure spring pressure in operating condition (Contacting commutator)	Spring scale (1 kg)	300 gr. (10.5802)	500~700 gr. (17.64~24.4902)	
④ Contact breaker spring	Measure spring pressure when point opens	Spring scale (1 kg)	500 gr. (21.1602)	800~1,000 gr. (28.22~35.2702)	
⑤ Commutator outer diameter	Measure outer diameter	Caliper	45 mm (1.772 in)	45 mm (1.811 in)	
⑥ Ignition coil	Calibrate 3-point gap	3-point gap scale, voltmeter, tachometer	5 mm (0.199 in) at 300 rpm 8V, 6 mm (0.237 in) at 7000 rpm 12V.	Over 7 mm (0.276 in) at 300 rpm 8V, Over 8 mm (0.315 in) at 7000 rpm 12V.	
⑦ Spark plug gap		Gap gage	Over 0.4 mm (0.0158 in) Under 0.7 mm (0.0276 in)	0.5~0.6 mm (0.0197~0.0236 in)	Adjust spark plug gap as standard valve Do not strike or force core terminal
⑧ Spark plug insulation resistance	Ground F lead wire and measure voltage between 61 terminal and ground.	100V megger	Over 20 MΩ	Over 50 MΩ	Clean or replace
⑨ Starter dynamo generating voltage		Voltmeter (0.5 class), Tachometer		15~16 V at over 1300 rpm	

5-5. Regulation

Check point	Measurement		Adjustment		Remarks
	Process	Total	Standard	Disposition	
1) Regulator no load voltage	Connect starter dynamo and regulator. Connect voltmeter + terminal to regulator 61 terminal and ground - terminal. Start engine and hold at 2000-3000 rpm. Measure voltage.	Voltmeter (0.5 class) Max. Reading 30V Min. Reading 0.1V Tachometer Max. 5000 rpm Min. 50 rpm	15-16 V at over 1500 rpm	See section on Regulator Adjustment.	
2) Regulator resistor load voltage	Insert ammeter and variable resistor between 39 terminal and ground. Turn engine. Apply following currents and check voltage: a) 8A when starter dynamo charge lead wire is connected to 61 terminal. b) 12A when connected to 62 terminal.	Voltmeter Ammeter Tachometer	13.5 V at over 1500 rpm		Adjust at specialized shop.
3) Regulator cut-in voltage	Under condition 2, raise engine rpm gradually. Measure rpm and voltage when ammeter needle begins to fluctuate.	Voltmeter Ammeter Tachometer	13-14 V at under 1300 rpm		Same as 2.

Item	Process	Procedure
1.	Remove regulator cover	Remove cover screws.
2.	Remove 61 terminal lead wire	Remove lead wire. Be careful to keep it from touching scooter body.
3.	Connect 30 V DC voltmeter	Connect + terminal to 61 terminal on regulator and ground - terminal.
4.	No load voltage check	a) Start engine. b) Raise engine rpm and hold at 2000-3000 rpm. Check voltage. Adjust according to section 5 if outside of 15-16 V range c) Turn switch off.
5.	Regulator Adjustment (see Fig. S4)	A. Regulator Adjustment a) Loosen lock nut on voltage adjusting screw. b) Turn adjusting screw. c) Turn right to raise and left to lower voltage. d) 1/4 turn will cause a change of about 0.6 V. e) Tighten lock nut after adjusting.

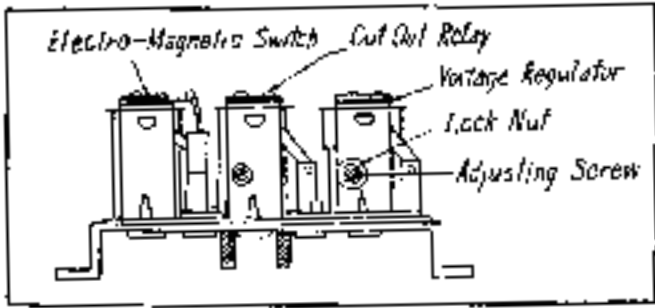
Item	Process	Procedure
		 <p style="text-align: center;">Fig. 34 d</p> <p>B. Engine Starting Start engine.</p> <p>C. No load voltage check</p> <ol style="list-style-type: none"> a) Hold engine at 2000-3000 rpm. b) Check voltage and readjust if necessary. c) Raise engine rpm (max. 5000 rpm) and check ammeter reading. Readjust if excessive. d) After obtaining the desired voltage, stop start and recheck at least twice.
6.	After adjustment	<ol style="list-style-type: none"> a) Stop engine. b) Remove ammeter. c) Apply red paint and mark position of adjusting screw and lock nut. d) Install cover. e) Seal. f) Fix lead wire to 5I terminal with screw.
7.	Cautions	<ol style="list-style-type: none"> a) Always stop engine before adjusting regulator. b) Always adjust under no load condition. (5I terminal lead wire disconnected) c) When rechecking voltage (5-C. Q) and reading is unstable or adjusting screw causes no change, take to service shop for readjustment. e) Do not touch any part except that marked by a circle.

6. REASSEMBLY

With the completion of inspection and adjustments after disassembly, use extreme care in reassembling the engine.

6-1. Engine Proper Subassembly



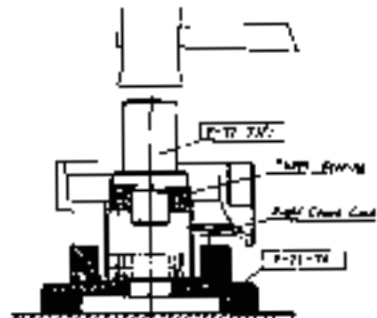

1. 1 Engine Proper Subassembly



SEQ	FIG	PART	PROCESS	PROCEDURE/CARE	SPECIAL TOOL
1		Crankshaft	(a) Force-fitting crank pin into left crankshaft.	(1) Apply engine oil to fitting surfaces and force in straight. (2) Force into outer side surface of crank web.	
			(b) Insertion of connecting rod, roller bearing race and roller side plate into crank pin.	Assemble the connecting rod with the mark toward the crankshaft left side.	
			(c) Force fit right crankshaft into condition after (b).	(1) Apply engine oil to fitting surfaces and force in straight. (2) Force fit so that the side clearance with big end assembled will be 0.2—0.4.	
2	35	Right Crankcase	Force fit ball bearing and right spacer.	(1) Place outer side of crankcase down on the retainer and force fit bearing, spacer, and bearing in this order using special tool.  <p style="text-align: center;">Fig. 35</p> (2) Force fit so that bearing outside surface protrudes 1.075-mm from crankcase end surface. When the bearing is inserted to the full depth of the retainer, this condition will result. (3) Insert spacer with step on the outside. (4) Force fit so that no gap results between bearing and spacer. (5) Apply engine oil to fitting surfaces and force in straight.	Y-72-74 Y-72-73/1
3		Left Crankcase	Force fit bearing, left spacer, oil seal and "O" ring.	(1) Force fit according to 2-(1).	Y-72-73/1

SEQ	FIG	PART	PROCESS	PROCEDURE/CARE	SPECIAL TOOL
	36			 <p>Fig 36</p> <p>(2) Force in until outer bearing surface is level with crankcase surface.</p> <p>(3) Oil seal and "O" ring is a unit with the spacer.</p> <p>(4) Match the spacer oil hole with the crankcase oil hole.</p> <p>(5) Sometimes the "O" ring will tear and clog the oil hole during fitting. Check and remove.</p> <p>(6) Bearing retainer plate.</p>	



6-2. Engine Proper Assembly



SEQ	FIG	PART	PROCESS	PROCEDURE/CARE	SPECIAL TOOL
1	109	Assembly of crankshaft and crankcase	<p>(a) Force fit left crankcase into crankshaft</p> <p>(b) Measure depth of right crankcase bearing surface.</p> <p>(c) Measure side surface of crankshaft</p> <p>(d) Side gap</p> <p>(e) Force fit right crankcase into crankshaft</p>	<p>(1) Force fit until surface of inner side bearing is level with crank web surface.</p>  <p>Fig. 37</p> <p>(2) Apply engine oil to fitting surface and force fit.</p> <p>Measure the depth from the crankcase fitting surface to surface of inner side bearing.</p> <p>Measure the height between the left crankcase fitted surface and the inner ring retaining surface of crankshaft right crankcase bearing.</p> <p>(1) Calculate gap from results of (b) and (c). Insert spacers on starter dynamo side so that side gap will be 0.03—0.12.</p> <p>(2) Three thicknesses of spacers are available, 0.1-mm, 0.2-mm and 0.29-mm.</p> <p>(1) Apply liquid packing to crankcase fitting surface.</p>	Y-72-62





SEQ	FIG	PART	PROCESS	PROCEDURE/CARE	SPECIAL TOOL
	2R			 <p>Right Crankcase</p> <p>Fig. 38</p> <p>(2) Tap in rock pin.</p>	Y-72-63
2	39	Piston pin and cylinder	(a) Piston	 <p>Fig. 39</p> <p>(1) Force fit piston pin with piston ring locking neck on exhaust side.</p> <p>(2) Insert circlip.</p> <p>(3) Install piston rings.</p>	Y-79-713
			(b) Cylinder	<p>(1) Insert packing.</p> <p>(2) Apply clean engine oil to cylinder interior.</p> <p>(3) Compress rings and install with exhaust port to front.</p>  <p>Fig. 40</p> <p>(4) Insert spring washers and fix with 4 nuts.</p> <p>(5) Torque to 2 kg-m (174 in-lbs).</p>	
2	41	Cylinder Head	Cylinder head installation	 <p>Fig. 41</p> <p>(1) Fit the gasket into place.</p> <p>(2) Install the cylinder head with the</p>	

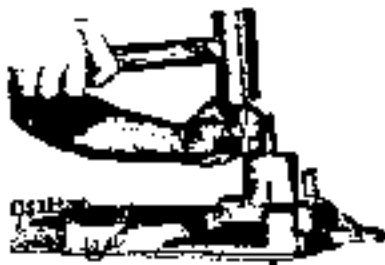

SEQ	FIG	PART	PROCESS	PROCEDURE/CARE	SPECIAL TOOL
	42			<p>spark plug hole on the electric starter side.</p>  <p>Fig. 42</p> <p>(3) Special internal wrenching bolts are used for installation. (4) Torque to 2.6 kg-m (226 in-lbs).</p>	
4	43	Starter base	Stator base installation	<p>Insert the "O" ring in the shoulder portion of the crankcase.</p>  <p>Fig. 43</p>	

6-3. Chaincase Assembly

1	44	Left Chaincase	<p>(a) Force fitting of intermediate sprocket bearing</p> <p>(b) Installation of oil level gage bolt</p>	<p>(1) Apply engine oil to the bearing surfaces and force in straight.</p>  <p>Fig. 44</p> <p>(2) Force in until flush with the oil filler hole level. (1) Insert packing.</p>	Y-72-68
2	45	Right Chaincase	<p>(a) Force fitting of intermediate sprocket bearing</p>	<p>(1) Apply engine oil to the bearing surfaces and force in straight.</p>  <p>Fig. 45</p>	Y-72-68



SEQ	FIG	PART	PROCESS	PROCEDURE/CARE	SPECIAL TOOL
				(2) Force in until flush with top surface of boss.	
			(b) Force fitting of rear wheel shaft bearing (sprocket side)	(1) Apply engine oil to the bearing surface and force in straight.	Y-72-68
46				 <p>Fig. 46</p>	
				(2) Force in until flush with top surface of boss.	
			(c) Installation of bearing retainer plate		
			(d) Force fitting of rear wheel shaft	(1) Apply engine oil to the bearing surfaces and force in straight.	Y-72-88
				 <p>Fig. 47</p>	
				(2) Force in until rear wheel shaft flange contacts bearing.	
			(e) Force fitting of rear wheel shaft bearing (tire side)	(1) Apply engine oil to the bearing surfaces and force in straight.	Y-72-68
				 <p>Fig. 48</p>	
				(2) Force in to the full depth of boss.	
			(f) Force fitting of oil seal	(1) Apply engine oil to the bearing surfaces and force in until flush with boss surface.	Y-72-68

SEQ	FIG	PART	PROCESS	PROCEDURE/CARE	SPECIAL TOOL
	49			 <p>Fig. 49</p> <p>(2) Use a punch and caulk around its circumference.</p>	
		(g) Force fitting of bushing		<p>(1) Apply engine oil to the bearing surfaces and force in fully until it contacts bearing.</p>  <p>Fig. 50</p>	Y-72-68
	50		(h) Installation of brake stop shaft	<p>(1) Insert "O" ring in brake stop shaft groove and fix with nut.</p> <p>(2) Torque nut to 4 kg-m (350 in-lb).</p>	
		(i) Force fitting of intermediate sprocket		<p>(1) Apply engine oil to the bearing surface and force in straight.</p>  <p>Fig. 51</p>	
	51		(j) Installation of rear wheel shaft sprocket	<p>(1) Insert sprocket in rear wheel shaft spline.</p> <p>(2) Insert washer and fix in place with double nut.</p> <p>(3) Models with cotter pin locking nut, insert cotter pin.</p>	
		(k) Installation of free wheel		<p>(1) Insert 1-mm washer between free wheel and casing.</p>  <p>Fig. 52</p>	
	52				

SEQ	FIG	PART	PROCESS	PROCEDURE/CARE	SPECIAL TOOL
	53		(l) Installation of chain	<p>(2) Insert sprocket in oil seal part.</p> <p>(1) Insert primary chain and fix in place with connector link</p>  <p>Fig. 53</p> <p>(2) Insert secondary chain and fix in place with connector link.</p> <p>(3) Insert connector link with opening against chain movement direction.</p>	
			(m) Installation of dust plate		
3	54	Left and Right Chaincase Assembly		<p>(1) Force in the intermediate sprocket shaft installed in the right chaincase into the bearing in the left chaincase.</p>  <p>Fig. 54</p> <p>(2) Fix in place with bolts.</p>	Y-72-62

6-4. Complete Engine Assembly

SEQ	FIG	PART	PROCESS	PROCEDURE/CARE	SPECIAL TOOL
1		Assembly of Engine and Chaincase		<p>(1) Insert packing and 1.8 t washer.</p> <p>(2) Install chaincase matching neck and fix in place with bolts.</p> <p>(3) Torque bolts to 2.7 kg-m (23.4 in lb).</p>	
2		Installation of Starter Base		(1) Install stator base and fix in place with bolts.	
3		Installation of Electric Starter Dynamo	(a) Armature	<p>(1) Insert armature in crankshaft matching key groove.</p> <p>(2) Insert and tighten 10-mm bolt.</p>	Y-79-650

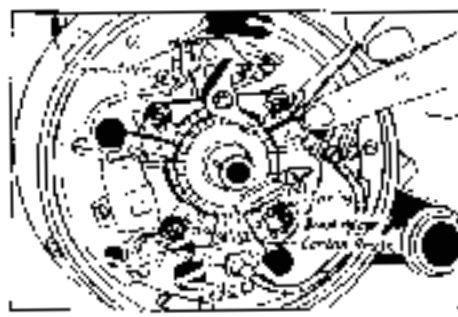
SEQ	PIC	PART	PROCESS	PROCEDURE/CARE	SPECIAL TOOL
55				<p>using special tool.</p>  <p style="text-align: center;">Fig. 55</p> <p>(3) Torque bolt to 3.7 kg-m (325 in lb). (4) Extract the 10-mm bolt.</p>	Torque wrench
56		(b) Stator		<p>(1) Insert stator on the stator base with the top mark (red line) straight up.</p>  <p style="text-align: center;">Fig. 56</p> <p>(2) Fix in place with 4 screws. (3) Hold the lead wires together and pull out together from the outlet hole. (4) Contact the carbon brush to the commutator and press in place with spring.</p>	
57		(c) Fan		 <p style="text-align: center;">Fig. 57</p> <p>(1) Insert fan matching it with key groove in armature taper shaft. (2) Fix in place with 10-mm bolt.</p>	

58



Fig. 58

(3) Torque to 3 kg m (260 in-lb)

Torque Wrench

(d) Adjustment of Contact Breaker Point Gap

- (1) Match the top marks on the fan and stator.
- (2) Check the point gap with a feeler gage.
- (3) Point gap=0.3 to 0.4 mm.
- (4) Adjustment of point gap is performed by loosening the contact breaker plate installation bolt and turning the eccentric screw.

Feeler gage



Fig. 59

59

e) Firing Angle Check

- (1) When the contact breaker point is open, see whether the red line mark without the "T" on the fan coincides with the mark on the stator.
- (2) If the marks do not match, adjust by loosening the installation screws on the adjusting plate on which the contact breaker plate is installed.

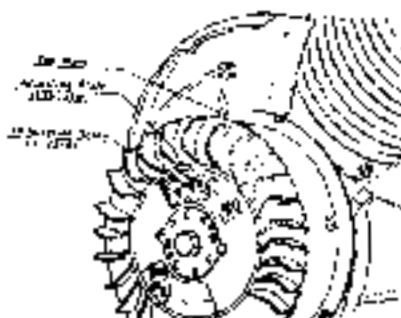



Fig. 60

(3) Firing angle (initial setting) is $5^{\circ} \pm 1.5^{\circ}$.

60

(f) Dust Cover Installation

SEQ	FIG	PART	PROCESS	PROCEDURE/CARE	SPECIAL TOOL
4		Fan Cover		(1) Install fan cover. (2) Install baffles.	
5		Spark Plug		(1) Install spark plug. (2) Install rubber packing inside fan cover.	
6	61	Fluid Torque Converter		(1) Match the protrusions on the free wheel and the torque converter. Fit it into the key groove in the crankshaft and install.  Fig. 61 (2) Fix in place with nut. (3) Torque nut to 6.7 kg-m (500 in-lb)	
7		Carburetor		(1) Assemble the intake pipe on the carburetor. (2) Attach the intake pipe to the cylinder. (3) Be sure to insert packing.	Y 78-236
8		Torque Converter Fluid Reservoir		(1) Loosen the rubber connector on the clip and install reservoir. (2) Attach reservoir base to chaincase.	

6-5. Preparations for Trial Operation

ITEM	PROCEDURE	CAUTION
1) Muffler	Install	
2) Engine	<ol style="list-style-type: none"> 1. Insert spacer into front mounting and attach engine with shaft bolt 2. Attach engine rear part (chaincase) to oil damper and air spring. 3. Attach air cleaner 4. Connect air cleaner and carburetor with rubber duct. 5. Connect regulator and starter dynamo wirings; throttle, starter device and brake cables; and fuel pipe. 	Fix electric wirings securely. Adjust throttle cable to lever play.
3) Chaincase	Remove filler cap and fill with 300-400 cc of SAE #30 motor oil	
4) Torque converter oil	Remove reservoir cap and one of the plugs on casing. Fill with 0.8 liter of torque converter oil.	Bring open plug hole position to top for filling and replace plug when oil overflows from the hole.

ITEM	PROCEDURE	CAUTION
5) Fuel	Add mixed fuel, Gasoline and 2-stroke oil at 25 to 1. 20 to 1 for first 1,000 km (600 mi);	1 Mix fuel thoroughly. 2. Keep fuel clean.
6) Starting	1. Open fuel cock and turn switch on. 2. Open throttle slightly and push starter button. 3. In cold weather, pull choke knob out and press starter button with throttle closed. 4. When excessive fuel intake occurs, push choke knob back and gradually open throttle while pressing starter button.	
7) Adjustment and checks	1. Carburetor 2. Contact breaker point gap 3. Ignition angle if necessary 4. Loose or missing parts 5. Abnormal noise or vibration 6. Mounting grease	

7. TROUBLE SHOOTING

7-1. Starter

PHENOMENA	POSSIBLE CAUSES
<p>(1) Starter main switch is switched on and the starter button pushed but the engine does not turn over (starter motor does not turn over)</p>	<p>A. When no noise can be heard</p> <ol style="list-style-type: none"> 1. Battery: Loose terminals, corrosion, (+) terminal grounded, over discharge, or more battery life. 2. Regulator: Break in internal wiring, grounded, short circuit, (30) (50) (51) terminals grounded or loosened. 3. Main Switch: Starter button damage. 4. Broken or grounded connector wiring.
	<p>B. When a clicking noise is heard</p> <p>(a) Headlight brilliancy does not change when the starter button is pushed</p> <ol style="list-style-type: none"> 1. Regulator: Bad connection between (A) terminal and ground, bad connection in magnetic switch. 2. Starter Dynamo: Poor contact of starter terminal (the terminal connected to the (A) terminal with wiring), poor contact or break in brush part.
	<p>(b) Headlight brilliancy changes (grows darker) when the starter button is pushed</p> <ol style="list-style-type: none"> 1. Battery: Over discharge, no more battery life. 2. Regulator: (A) (51) terminals grounded, poor or grounded internal wiring. 3. Starter Dynamo: Grounded internal wiring, poor connection or short circuit. 4. Connector Wiring: Starter input lead wire (A terminal connection) grounded, dynamo output lead wire (51) terminal connection) grounded. 5. Mechanical Trouble: Dirt between revolving and stationary parts.
<p>(2) When the starter main switch is switched on and the starter button pushed, the engine turns over (starter motor turns over) but does not catch (engine does not start to turn over by itself)</p>	<p>A. When there are fluctuations</p> <ol style="list-style-type: none"> 1. Battery: Over discharge, no more battery life, poor connection of terminals. 2. Regulator: Poor contact at (30) (A) and starter terminals, poor contact in magnetic switch, wiring starting to break. 3. Starter Dynamo: Poor internal connection, break, grounding or short circuit; abnormal friction in rotating part (low rotating speed). 4. Ignition Coil: Grounding of primary circuit. 5. Connection Wires: Break or grounding in starter circuit, (A) (30) (50) terminal wirings. 6. Engine: Improper lubricant (especially in winter), fuel system trouble (there is gasoline flow but throttle opening is improper).

INSPECTION PROCEDURE

ITEM	PROCEDURE	INSTRUMENT	STANDARDS	
Battery	Main Switch OFF	Check terminal voltage Check specific gravity	Tester Hydro- meter	Over 12V Good Over 1.280 calculated to 20°C Good
Regulator	Main Switch OFF	Check resistance between (50) terminal and earth.	Tester	5~15Ω
Regulator	Main switch ON Starter button ON	Check voltage between (A) terminal and ground.	Tester	Over 12V Regulator Good Starter and Regulator connection Bad Starter Bad 0V Regulator Bad
Battery	Main switch Headlight ON	Check battery terminal voltage.	Tester	No voltage drop, battery over 12V Good Gradual drop in voltage Bad
Regulator		Check grounding of (A) (61) terminals and all connecting wirings.		
	Main switch ON Starter button ON	Check voltage between (30) terminal and ground.	Tester	7~8V = Starter dynamo and regulator Good (mechanical trouble) Over 9V, under 6V = Starter dynamo and Regulator Bad
	Release A terminal wiring Main switch ON Starter button ON	Check voltage between (A) terminals and ground.	Tester	At 12V Regulator Good Starter Dynamo Bad
Battery	Main switch ON Starter button ON		Tester	Over 9V Good Under 8V Bad
Regulator	Main switch ON Starter button ON		Tester	Under 0.5V Good Over 1V Bad
Starter dynamo	Main switch ON Starter button ON		Tester	Under 9V Good Over 10V Bad

PHENOMENA	POSSIBLE CAUSES
	R. When rotation is normal See Section 3—STARTING TROUBLE (Excluding Electric Starter)

7-2. Dynamo

PHENOMENA	POSSIBLE CAUSES
(1) The engine catches and revolution exceeds 2000 r.p.m. but charge light does not switch off.	<ol style="list-style-type: none"> 1. Starter Dynamo: Break in field coil or field coil lead wire, poor terminal contact. 2. Wiring Connection: Break in or poor contact of dynamo output wire ((61) terminal connecting wire). 3. Short circuit or overloading of loading circuit (lighting, etc.). 4. Regulator: Damaged cutout relay.
(2) Charge light switches off but lights again at over 2000 r.p.m.	<ol style="list-style-type: none"> 1. Starter Dynamo: Carbon brush is not contacting due to over-wear or damaged spring, commutator is dirty from oil or dirt. 2. Regulator: Damage in cutout relay. 3. Short circuit or over loading in load circuit.
(3) Charge light goes off but the battery keeps discharging (when stopped, the headlight is dark or the horn noise is bad)	<ol style="list-style-type: none"> 1. Battery life has reached its end. 2. Circuit insulation poor. 3. Regulator damaged.
(4) Charge light goes off, but the battery fluid level drops quickly after adding distilled water.	<ol style="list-style-type: none"> 1. Damage in regulator interior. 2. Starter Dynamo: Field coil is grounded or has a short circuit.
(5) Engine starts gasping at high revolution and power output drops	<ol style="list-style-type: none"> 1. Faulty automatic advance angle, faulty contact breaker. 2. Faulty carburetor.

INSPECTION PROCEDURE			
ITEM	PROCEDURE	INSTRUMENT	STANDARDS
Check ignition and fuel system			

INSPECTION PROCEDURE				
WIRING	PROCEDURE		INSTRUMENT	STANDARDS
	ENGINE	CHECK		
Regulator Starter dynamo	Engine running (Lights OFF)	Measure voltage between (51) terminal and ground.	Precision Voltmeter	Over 13V Starter dynamo and Regulator Good Under 13V Starter dynamo and Regulator Bad
	Engine running at 200 rpm and (61) terminal disconnected	Measure voltage between (61) terminal (starter dynamo side, dynamo out- put wire) and ground	Tester	Over 15V Starter dynamo Good Regulator Bad Under 15V (See Section 3)
	Same as above with (F) terminal ground- ed	(Same as above)	Tester	Over 15V Starter dynamo Good Regulator Bad
	(Same as above)	(Same as above)	(Same as above)	(Same as above)
Regulator Starter dynamo	Engine running at 2500rpm for 2~3 minutes (Lights off)	Measure voltage between (51) terminal and ground.	Precision voltmeter	Over 14V Starter dynamo and Regulator Good Under 12.5V Starter dynamo and Regulator Bad
(Use same test procedures as PHENOMENA 1 and 2)				
Starter dynamo	Engine operated at 2500rpm for 2~3 minutes (F) termi- nal is released.	Measure voltage between (61) terminal and ground.	Tester	Under 2V Starter dynamo Good Over 5V Bad

7-3. Starting Difficulties

NO.	CAUSE	COUNTERMEASURE	SPECIAL TOOL	PRECAUTION
1	Excessive fuel intake	Close fuel cock and open throttle fully. Remove spark plug cap and push starter button for 3-4 seconds to discharge excess fuel. Removal of spark plug will make it simpler.		(1) Do not use choke when engine is warmed up. (2) Beware of clogged air cleaner which cause too rich fuel.
2	Faulty Spark plug	(a) If dirty, clean thoroughly in gasoline and dry. (b) Adjust gap to 0.5-0.6mm. (0.02-0.023 in) (c) Insulation may be damaged if spark plug is clean. Check with 1000 V megger. It should be over 50MΩ.	Feeler Gage, Megger (1000V)	(1) Use spark plug of proper heat value. High value spark plug at low speed will cause dirty plug. (2) When adjusting gap, hitting or forcing center pole will damage the insulation. (3) Check and adjust gap every 1000-1500 km (650-1000 miles).
3	Spark plug bridging	(a) Bridging is a short circuit caused by some foreign particle on the terminals. Clean off. (b) Granular substance adhering to the center pole insulation may be causing short circuit. This is difficult to remove.		It is important to keep the air cleaner properly maintained, to use clean fuel and to prevent the induction of dust and other foreign matter. Be very careful during disassembly and reassembly.
4	Poor Sparking performance	(a) The insulation capacity of the secondary coil in the ignition coil will decrease with use which can cause weakened sparking. Replace with new part. (b) Poor contact or faulty insulation of high tension wire. (c) Contact breaker point surface has become uneven from dust, oil and long usage. Adjust surfaces with oilstone until full contact is attained. (d) Improper contact breaker point gap. Gap should be 0.35 ± 0.6 mm. Check from time to time.	Oilstone Feeler Gage	(1) Be careful not to allow water to enter inside ignition coil. (2) Avoid high temperature and high humidity. (3) When testing spark, do not allow direct sparking between high tension wire and engine. (1) Prevent infiltration of dust. (2) Do not overgrease cam surface and breaker shaft. Improper gap will lead to some kind of trouble such as burnt points.
	Poor Compression	(a) Improper installation of intake pipe causing leakage. (b) Faulty crankcase compression due to worn down crankshaft oilseal. (c) Poor compression due to worn down piston and cylinder. (d) Pressure leakage from faulty cylinder head gasket (e) Leakage from spark plug seat.		Keep air cleaner properly serviced to prevent infiltration of dust. Dust will accelerate wear.
6	Faulty Carburetor	(a) When the needle valve and valve seat of float wears down, over-flow of fuel will occur. (b) The fuel mixture is too lean. Fuel mixture becomes lean in winter. Turn air screw 1/2 revolution to adjust.		

NO.	CAUSE	COUNTERMEASURE	SPECIAL TOOL	PRECAUTION
		(c) Clogged holes. The idle air hole and fuel line may be clogged.		(1) When filling fuel, be careful not to allow dust and dirt to enter. (2) Wash fuel tank and strainer with gasoline. Do not use water.

7-4. Trouble at Low Speeds

- (a) Improper firing angle. At the initial setting, the top should be 5° before, and at 1200-1500 rpm with a 21° angular advance, the top should be 26° before. When it becomes earlier than this, low speed troubles will occur.
- (b) The causes for starting trouble can also cause low speed troubles.

7-5. Overheating

- (a) The firing angle is too advanced.
- (b) Compression ratio is too high.
 - (1) The cylinder head gasket packing has worn thin.
 - (2) Residual matter has accumulated in the combustion chamber.
- (c) Heat value of the spark plug is too low. If the heat value is too low, the terminal will become overheated and cause spontaneous sparking which will raise the combustion chamber temperature and lower the power output.
- (d) The fuel mixture is too lean. Major causes are faulty adjustment of carburetor, clogged air holes, and poor compression in intake system.
- (e) Dirty cooling fins. Accumulation of dirt on the cylinder head and cylinder exterior can cause inadequate cooling. Clean every 10,000 km (6,000 miles).

7-6. Power Output Drop

- (a) Poor compression due to worn down cylinder, piston, and piston rings, and faulty cylinder head and spark plug gaskets.
- (b) Worn down crankshaft oil seal (2 each-left and right).
- (c) Faulty carburetor.
- (d) Poor sparking performance.
- (e) Air leakage in intake system.
- (f) Faulty spark plug (gas leak, poor sparking due to faulty insulation).
- (g) Overheating (specially when sudden power drop occurs during climbing and high speed operation).
- (h) Carbon accumulation in exhaust port and muffler.
- (i) Infiltration of air into torque converter from worn oil seal and rubber connector. (This will cause sudden power drop when climbing a hill.)

7-7. Explosion Outside Cylinder

- (a) Faulty contact point gap (specially for misfiring during high speeds).
- (b) Fuel is too rich or too lean.
- (c) Generation of heat point due to dirty combustion chamber and spark plug overheating.
- (d) Firing angle is too late.

7-8. Poor Acceleration

- (a) Faulty adjustment of carburetor. (Fuel is too rich or too lean.)
- (b) Poor sparking performance.
- (c) Air infiltration into torque converter.

7-9. Excessive Vibration

- (a) Excessive wobble of crankshaft.
- (b) Improper balance among starter dynamo rotor, fan and torque converter. (Rotor within 2 gr, fan within 1 gr, torque converter and impeller case within 3 gr, all at outer perimeter.)
- (c) Firing angle too advanced.
- (d) Fuel is too rich or too lean.
- (e) Compression pressure too high.
- (f) Excessive play in crankshaft bearing due to wear in bearing or housing.

7-10. Abnormal Noises

- (a) Excessive piston play.
- (b) Excessive play between piston pin and connecting rod small end.
- (c) Excessive radial and side play in connecting rod big end.
- (d) Worn down crankshaft bearing.
- (e) Improper installation of piston ring. (Gap should be toward exhaust side.)
- (f) Chaincase rattle due to stretching of chain.

ITEM	PROCEDURE	CAUTION
Charging for initial use	<ol style="list-style-type: none"> (1) This is a dry charge battery which is usable after filling fluid. However at initial filling, its capacity is 80 percent, and additional charging must be performed to raise it to its full capacity. (2) Remove wrapping and remove fluid filler plugs at three places. (3) Add diluted sulphuric acid of 1.280 specific gravity at 20°C to the top level line. Let it stand for 2-3 hours and fill again to the top line. (4) After filling fluid, charge for about 10 hours. 	<p>The specific gravity of battery fluid after completion of charging is 1.280 at 20°C.</p>
Check and Adjustment of Fluid Level	<ol style="list-style-type: none"> (1) The battery fluid level should be between the maximum and minimum level lines. (2) If the fluid level falls below the minimum level line, and distilled water up to the top level line. (3) If the fluid level exceeds the maximum level line, extract fluid until it reaches the proper level. (4) The battery fluid level should be checked at least once every month, but make it a point to check the fluid level when a scooter comes in for servicing. 	<p>When adjusting fluid level, always use DISTILLED WATER. Do not use diluted sulphuric acid as it will damage the battery.</p>
Recharging for long Storage	<p>When storing your scooter for an extended length of time, spontaneous discharging will cause fluid level to drop considerably. To prevent this, charge, about 5 hours every month.</p>	
Recharging (Checking the specific gravity and terminal voltage)	<ol style="list-style-type: none"> (1) Charging requirement is determined by the specific gravity of the battery fluid and the terminal voltage. Check these values once every month. (2) Check the specific gravity with the battery fluid at the proper level. However, do not check directly after addition of distilled water as the fluid will not be completely mixed. Check after operating the scooter for a while to mix the fluid thoroughly. (3) Recharge when the specific gravity falls below 1.200 (calculated to 20°C) and the terminal voltage drops below 12V. (4) Recharging may not be necessary due to certain conditions of scooter operation such as when starting frequency is very low, when night operation is hardly done and when travelling over long distance. 	
Wiring Check	<ol style="list-style-type: none"> (1) Do not mistake the (+) and (-) terminals. Tighten securely. (2) Corroded terminals (from battery fluid leaks) will lower performance. Check from time to time. 	

S601B SCHEMATIC LAYOUT OF ELECTRIC WIRING

Note: Dotted lines indicate white colored wiring

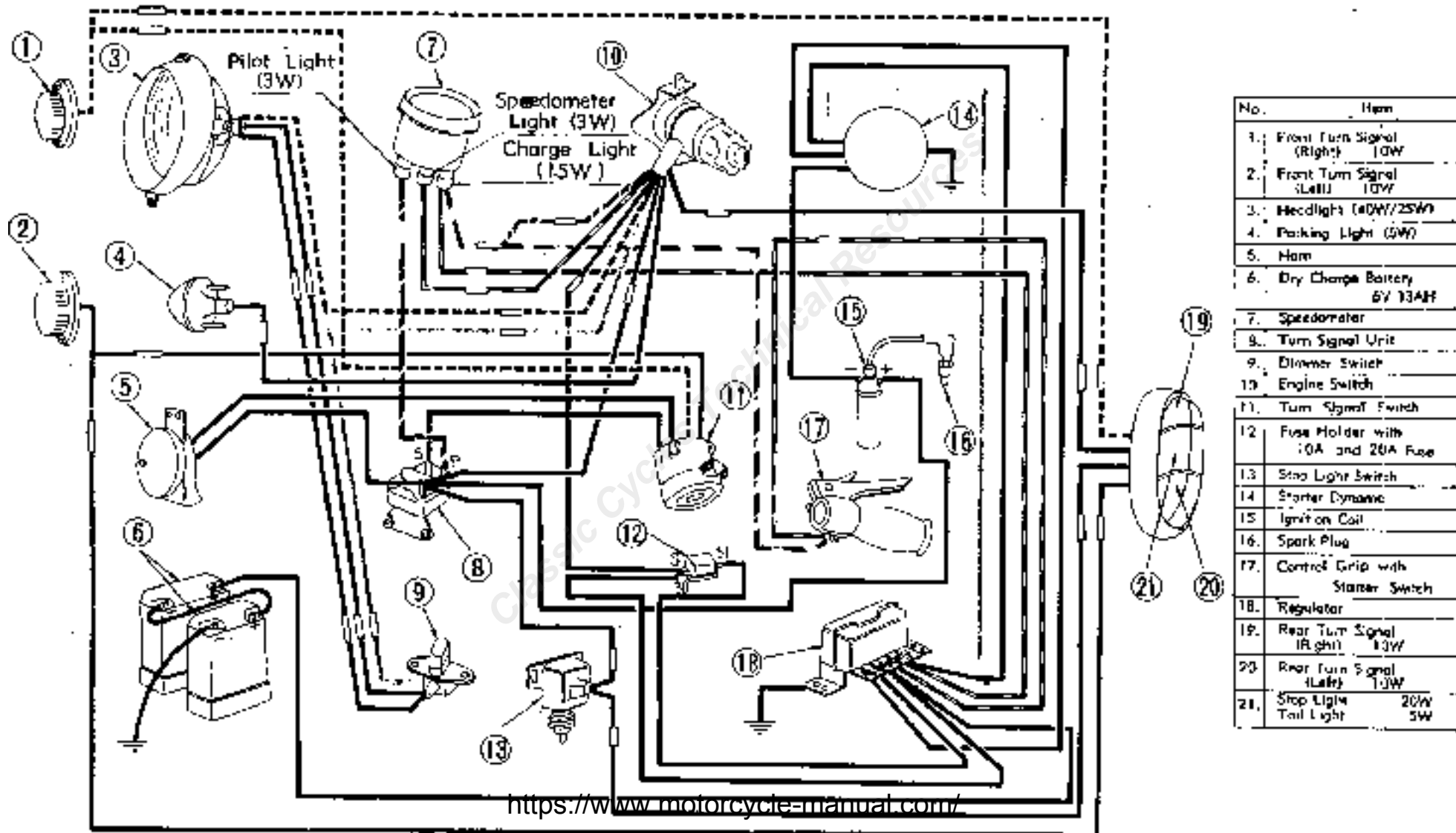

No.	Item
1.	Front Turn Signal (Right) 10W
2.	Front Turn Signal (Left) 10W
3.	Headlights (40W/25W)
4.	Parking Light (5W)
5.	Horn
6.	Dry Charge Battery 6V 13AH
7.	Speedometer
8.	Turn Signal Unit
9.	Dimmer Switch
10.	Engine Switch
11.	Turn Signal Switch
12.	Fuse Holder with 10A and 20A Fuse
13.	Stop Light Switch
14.	Starter Dynamo
15.	Ignition Coil
16.	Spark Plug
17.	Control Grip with Starter Switch
18.	Regulator
19.	Rear Turn Signal (Right) 10W
20.	Rear Turn Signal (Left) 10W
21.	Stop Light Tail Light 20W 5W

MOTORCYCLE PARTS & ACCESSORIES

Click on links below

[Fuji Rabbit Scooter History & Technical Specifications](#)

[Motorcycle Parts & Accessories](#)

[Dirt Bike Parts & Accessories](#)

[Harley Davidson Parts & Accessories](#)

[Motorcycle Helmet Closeout Sale](#)

[Japanese Motorcycle Original Equipment Parts](#)

[Save On All Motorcycle Tires](#)

[Motorcycle Jacket Closeout Sale](#)

[High Visibility Motorcycle Safety Gear](#)

[Cycle Gear – Free Shipping](#)

[Women's Motorcycle Riding Gear](#)

[Free Shipping On All Motorcycles](#)

[Save Up To 80% On All Car Parts](#)



<https://www.motorcycle-manual.com/>

www.ClassicCycles.org