

HEINKEL
Tourist

TOURIST
103 A-1

To all HEINKEL Dealers

This Manual is intended to assist you in carrying out all maintenance and repair work in your HEINKEL workshop.

Detailed drawings make the text easy to understand, so that no motor fitter should have any difficulty in carrying out any repairs quickly and rationally.

Correlation of the illustration references with the text is simplified by figures. For example, 10/2 : 10 is the number of the illustration and the figure 2 after the oblique stroke refers to the part number in the illustration in question.

All repairs, particularly on the engine of the vehicle, should only be carried out with the proper special tools. For repairs, never use any but Original HEINKEL spare parts or Original HEINKEL Exchange Parts, as otherwise our part of the Guarantee becomes invalid.

Our Customers' After-sale Service Department will always welcome any hints and suggestions which you may care to give us for the enlargement and improvement of this Manual.

**ERNST HEINKEL AKTIENGESELLSCHAFT
STUTTGART-ZUFFENHAUSEN**

To all HEINKEL Owners

This Manual is intended to assist you in having carried out all maintenance and repair work in your HEINKEL dealer's workshop. Besides, we believe that many of you are interested in knowing more about your HEINKEL TOURIST motorscooter than we can tell you in the Owner's Manual. Furthermore this Manual might help you when travelling abroad, especially when travelling in countries where on account of importation restrictions or for other reasons no HEINKEL workshops can be found, in case of trouble you might show this copiously illustrated Manual for information to the workshop people and thus save precious time and money.

We draw your attention to the fact that all repairs, particularly on the engine of the vehicle, should always be carried out with the proper special tools. For repairs, never use any but

Original HEINKEL Spare Parts or
Original HEINKEL Exchange Parts,

as otherwise our part of the Guarantee becomes invalid.

Detailed drawings make the text of this Manual easy to understand. Correlation of the illustration references with the text is simplified by figures. For example, 10/2 : 10 is the number of the illustration and the figure 2 after the oblique stroke refers to the part number in the illustration in question.

ERNST HEINKEL AKTIENGESELLSCHAFT
STUTTGART-ZUFFENHAUSEN

Contents

Foreword	1, 1a
Technical Data	3
Exchange Engine	6
Special Tools	7
Miscellaneous	9
Dismantling and reassembling the engine	9
Dismantling the Cylinder Head, Cylinder and Piston	11
Reassembling the Cylinder Head, Cylinder and Piston	12
Adjusting the valves	13
Dismantle, ream but and assemble connecting rod bush	14
Dismantle and assemble cylinder Head, grind in valves	15
Check Piston and Cylinder	17
Table of Measurements and Oversizes (Cylinder and Piston)	18
Dismantling the Clutch	19
Fitting the Clutch	21
Dismantling the Dynamo	23
Assembling the Dynamo	25
Adjusting the Ignition	27
Measuring voltage and current on Dynamo and Governor Switch	28
Measuring Voltage on the Dynamo	28
Measuring charging current	28
Dismantling the Swinging arm	29
Fitting the Swinging Arm	31
Table of Bolts	33
Tightening Torques for Bolts and Nuts	33
Dismantling Crankshaft and Bearing	34
Fitting Crankshaft and Bearing	35
Dismantling the Gears	37
Fitting the Gears	38
Removing, dismantling and refitting of Carburettor	39
Removing, dismantling and refitting of BING Carburettor	39
Removing, dismantling and refitting of PALLAS Carburettor	41
Removing and Fitting the Front Fork	43
Disassembling and Fitting of the Front Fork	44
Removing and Fitting of Frame and Fork Ball Races	44
Removing and Fitting of Front Wheel Hub	45
Removing and Fitting Brake Shoes	45
Adjusting the Gear Shift Arrangement	46
Adjusting the Clutch	46
Adjusting the Headlamp	47
Removing and Fitting of Frame	48
Power Curve	49
Speed Curve	49
Climbing Performance Curve	49
Fuel Consumption Curve	49
Wiring Diagram	50
Table of Loads	51
Drawing of Assembly Jig for Scooter	52
Drawing of Assembly Jig for Scooter Engine	53
Table for Service, Maintenance and Greasing	54

Technical data of motorscooter »HEINKEL-TOURIST«, model 103 A-1

Engine

Engine model	407 A-1	
Engine cycle	Four-stroke	
Number of cylinders	1	
Arrangement of Cylinders	Vertical	
Bore	60 mm. Ø	
Stroke	61.5 mm.	
Swept Capacity	174 cc.	
Clearance volume	27.5 cc.	
Compression ratios	1:7.4	
Output	9.2 h.p. at 5500 r.p.m.	
Compression pressure	130 lbs per sq. inch. (When fuel valve is open and the engine is warm)	
Piston play	0.05–0.06 mm.	
Diameter of gudgeon pin	18 mm. Ø DIN 73121 (watch the identification colours)	
Bore of compression ring	18 mm. Ø	+ 0.025 mm. + 0.040 mm.
Seating of crank assembly	2 × annular groove bearings 6305 C 3	
Seating for clutch shaft	1 × annular groove bearings 6203 C 3	
Valve arrangement	Overhead valves (V-type) in fully enclosed light-metal cylinder head	
Valve clearance	Inlet valve 0.15 mm. Exhaust valve 0.20 mm.	} measured on cold engine
Valve timing	Inlet/Exhaust 18° after t.d.c. Inlet/Inlet 17° after b.d.c. Exhaust/Exhaust 18° before b.d.c. Exhaust/Inlet 19° before t.d.c.	
Diameter of valve stems	Inlet 6.975 mm. Ø — 0,01 mm. Exhaust 6.965 mm. Ø — 0,01 mm.	
Bores of valve guides	Inlet 7 mm. Ø + 0.028 mm. Exhaust 7 mm. Ø + 0.013 mm.	
Valve spring pressure	30.0 kg (valve open) 10.3 kg (valve closed)	
Cooling	Fan-cooling	
Lubricating system	Oil-bath centrifugal lubrication	
Ignition		
Type of ignition	Starter/Generator unit "BOSCH" 12 volt coil ignition with automatic timing, 12 volts, 90 watts (AZ/DAQ 90/12/1700 + 0.2 R 2)	
Spark timing	Retarded ignition 0.6—0.8 mm. before t.d.c, using timing tool (404/W 10) or 8°—10° before t.d.c. (when setting by means of the graduated disc) Advanced ignition 6.5—7 mm. before t.d.c. or 33°—35° before t.d.c. (when setting with the governor fully open)	
Gap between contact breaker points	0.35—0.45 mm.	
Spark plug calorific value	225 *) today: BOSCH W5 AC or NGK B7 HS or Champion L81C	
Spark plug thread	M 14 X 1.25	
Spark gap	0.5—0.6 mm.	

Carburettor

Needle type carburettor with accelerating pump	Pallas Type 20/14 P	Bing Type 1/20/46
Carburettor passage	20 mm.	20 mm.
Main jet	80(85)	85
Slow-running jet	25	35
Needle jet	2701	2.66
Needle setting	3	3
Jet needle, conical		15 x 1.95 Ø number 3
Mixture screw	2½ x turns open	1½ turns open adjust to best idling
Air filter	"Knecht" micronic air filter	

*) see [pteng](http://www.pteng.de) (www.pteng.de)

Clutch

Clutch
Operation of clutch
Clutch spring pressure
Thickness of outer plate
Clutch adjustment

Oil-bath multiple-disc clutch
By hand on left handlebar
60—70 kg.
max. 5.0 mm. min. 4.0 mm.
2—3 mm. on the clutch lever (on handlebars)

Gearbox

Gearbox
Method of engagement
Power Transmission
Engine-Gearbox
Power transmission
Gearbox-Rear wheel
Reduction Engine-Gearbox
Gear reduction ratios

Four-speed type
dogs
Single enclosed chain, $\frac{3}{8}$ " x $\frac{3}{8}$ " (56 links endless) , fully enclosed and oil-bath immersed.
Single roller chain, $\frac{1}{2}$ " x $\frac{5}{16}$ " reinforced, (70 links endless), fully enclosed and oil-bath immersed.
1.882:1
1st Gear 3,51 : 1
2nd Gear 2,07 : 1
3rd Gear 1.38 : 1
4th Gear 1 : 1

Solo

Reduction ratio
Gearbox-Rear wheel 2.727:1

With Sidecar

Reduction ratio
Gearbox-Rear wheel 3.10 :1

Chain Wheels

Gearbox 11 teeth
Rear wheel 30 teeth

Chain Wheels

Gearbox 10 teeth
Rear wheel 31 teeth

Total reduction

1st gear	18.05:1
2nd gear	10.60:1
3rd gear	7.10:1
4th gear	5.13:1

Total reduction

1st gear	20.50:1
2nd gear	12.02:1
3rd gear	8.06:1
4th gear	5.83:1

Chassis

Frame
Engine suspension
Front wheel suspension
Rear wheel suspension

Offset of front axle
Caster action
Handlebar steering range
Steering (vertical) angle

Torsion-free tubular steel frame
Rubber-Insulated 3-point-suspension
Telescopic form with hydraulic shock-absorber
Fully-enclosed swinging arm, with telescopic, hydraulically damped suspension unit
92 mm. (unchanging)
18—20 mm.
50 degrees to left and right-hand sides
25°

Toe-in of sidecar wheel

18—20 mm.
(please respect any special stipulations of the sidecar manufacturers)

Camber of the machine

Up to 4 degrees (inclining towards sidecar) (please respect any special stipulations of sidecar manufacturers)

Handlebars

Pressed-steel handlebars with built-in speedometer (calibrated either in kilometers or in miles) and with twist -grip gear shift.

Brakes

Mechanical internally-expanding brakes, drum 140 mm. diam, width 25 mm.

Operation of brakes

Hand-lever for front-wheel brake,
Foot-operated pedal for rear wheel

Wheels

All interchangeable

Rims

Flat-base rims s. 50X10"

Tyres

4.00 x 10"

Tyre pressure
driver only
driver and passenger
driver with sidecar passenger
driver with pillion passenger
and sidecar passenger

Front wheel	Rear wheel	Sidecar
18 psi	26 psi	
18 psi	29 psi	
22 psi	29 psi	22 psi
22 psi	36 psi	29 psi

Dimensions and Weights

Wheelbase	1375 mm.
Overall length	2085 mm. (without rear luggage carrier)
Maximum width	710 mm.
Maximum height	1000 mm.
Height of seat	735 mm.
Ground clearance	approx. 145 mm.
Weight of vehicle, ready to be driven	150 kg.
Total weight admissible	350 kg.
Total weight admissible with sidecar	450 kg.

Fuel and lubricants

Fuel	Use a proprietary brand At least 82 octane (ROZ)
Fuel tank	Holds 11.3 litres, of which approx. 1 litre forms a reserve.
Lubricant	Use a proprietary brand, such as MOBIL OIL SPECIAL, for the whole year round. *)
Oil in the engine	Approx. 1.5 litres (to the mark on the dipstick)
Oil in the swinging arm	Approx. 0.15—0.20 litres
Fuel consumption, to DIN 70030 standards	3 litres per 100 km
Maximum speed	Approx. 92 km/h

*) Hint in year 2004: because of difficulties with the clutch, never use modern HD-oil or synthetic oil. Only use classic oil for the engine. See [pteng](http://www.pteng.de) (www.pteng.de)

In the interests of technical development, we reserve the right to make modifications.

Engine » HEINKEL - TOURIST «, model 407 A-1

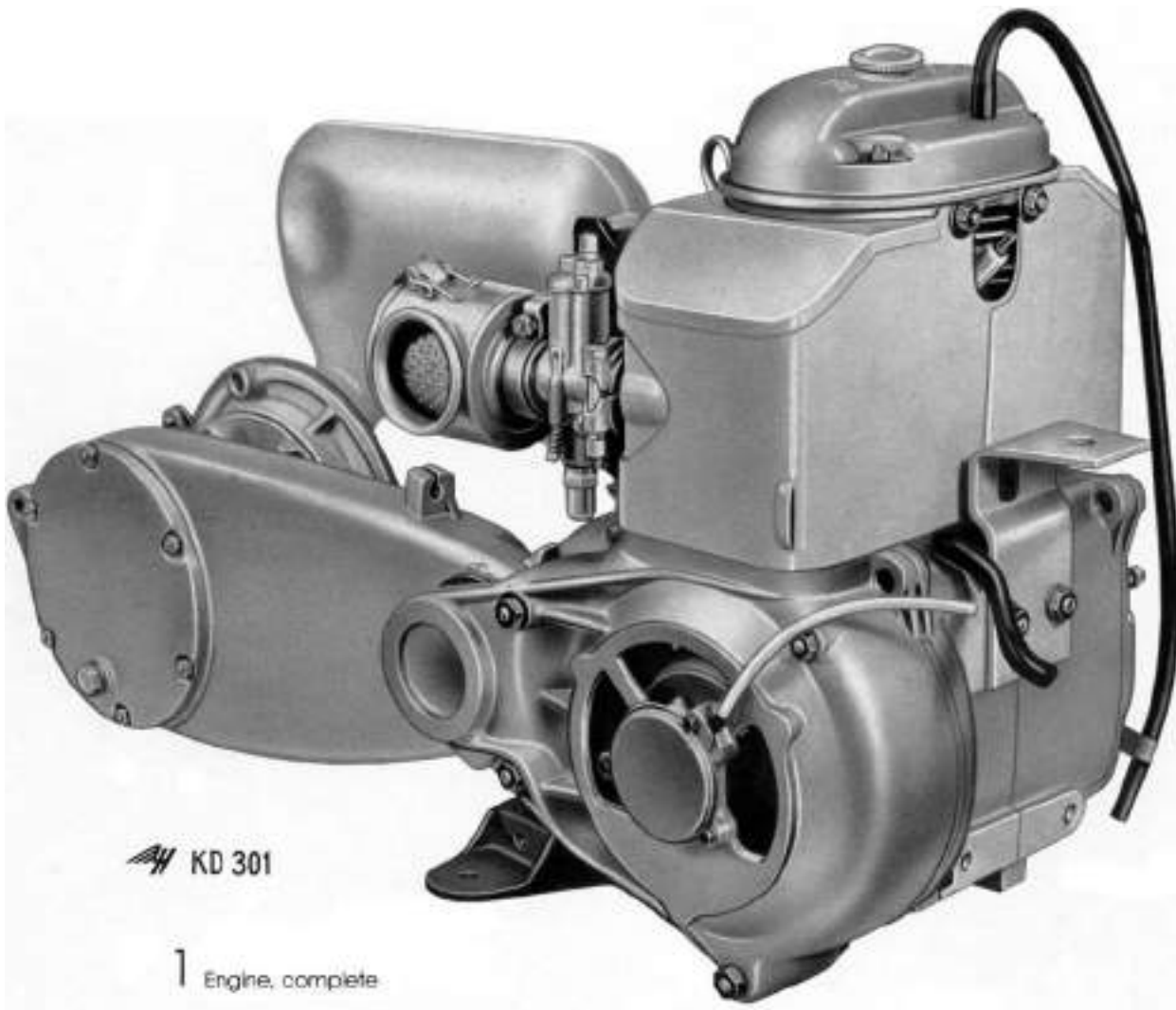

Exchange engine:

Engines to be returned to the factory under the exchange scheme must be as follows:

with swinging arm, complete, carburettor, exhaustmanifold, cooling baffles, dip stick, magneto, complete, with spark plug, clutch lever with traction spring and retainer plate, rear wheel hub with brake lever, all nuts, bolts and discs, and the support for the mounting of the exhaust silencer,

without air filter, exhaust silencer, air outlet tube, guiding piece for the Bowden cable operating the rear wheel brakes, support with sleeve for Carburettor Bowden cable.

Note: Owing to import restrictions, import duties and for other reasons it has not, unfortunately, been possible for the Factory to apply the German Engine Exchange Scheme to foreign countries.

Special Tools for »HEINKEL-TOURIST«

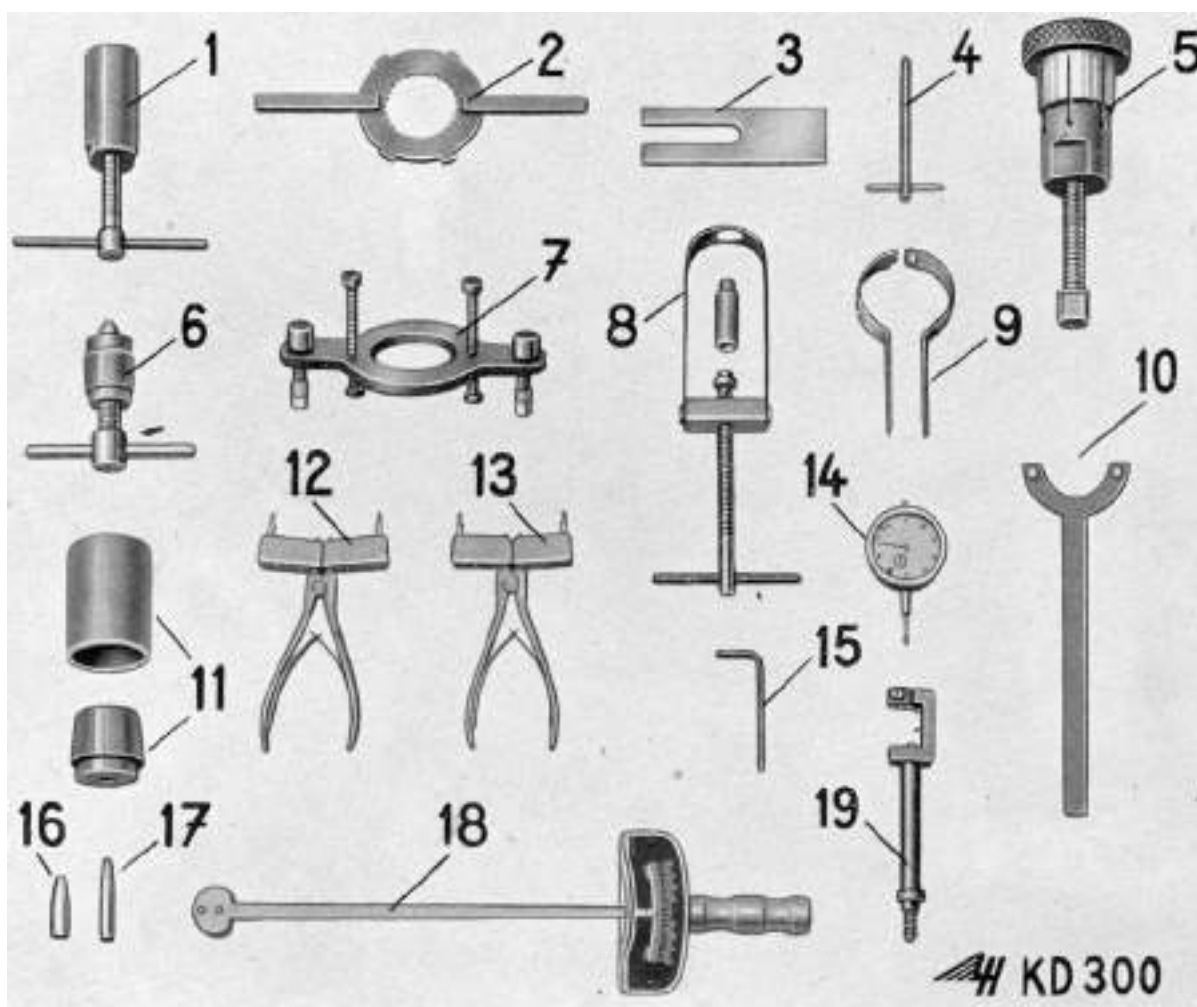

2 Special Tools

Key to illustration above:

No	Drawing No.	Description
1	401/W 22	Extractor for driven pinion
2	408/W 14	Clutch retainer
3	401/W 20	Retainer plate for piston
4	401/W 19	Guide pin for rocker arm axle
5	407.201/W 5	Ball-bearing extractor, Type 6305
6	404/W 7	Extractor for starter dynamo
7	401/W 25	Clutch compressor
8	401/W 26	Gudgeon pin extractor
9	407/W 20	Piston ring clamp
10	407/W 21	Retainer for starter dynamo
11	401 /W 21	Snap ring opener
12	401/W 8	Assembly pliers for brake shoes
13	401/W 10	Assembly pliers for brake shoes
14	commercial type	Meter for use with ignition timer
15	commercial type	5 mm. key for starter dynamo
16	407/W 30	Assembly sleeve for radial gasket
17	407/W 29	Assembly sleeve for sealing cap
18	commercial type	Tension wrench (Torque-metering spanner) 0-6 mkg.
19	404/W 10	Ignition timer

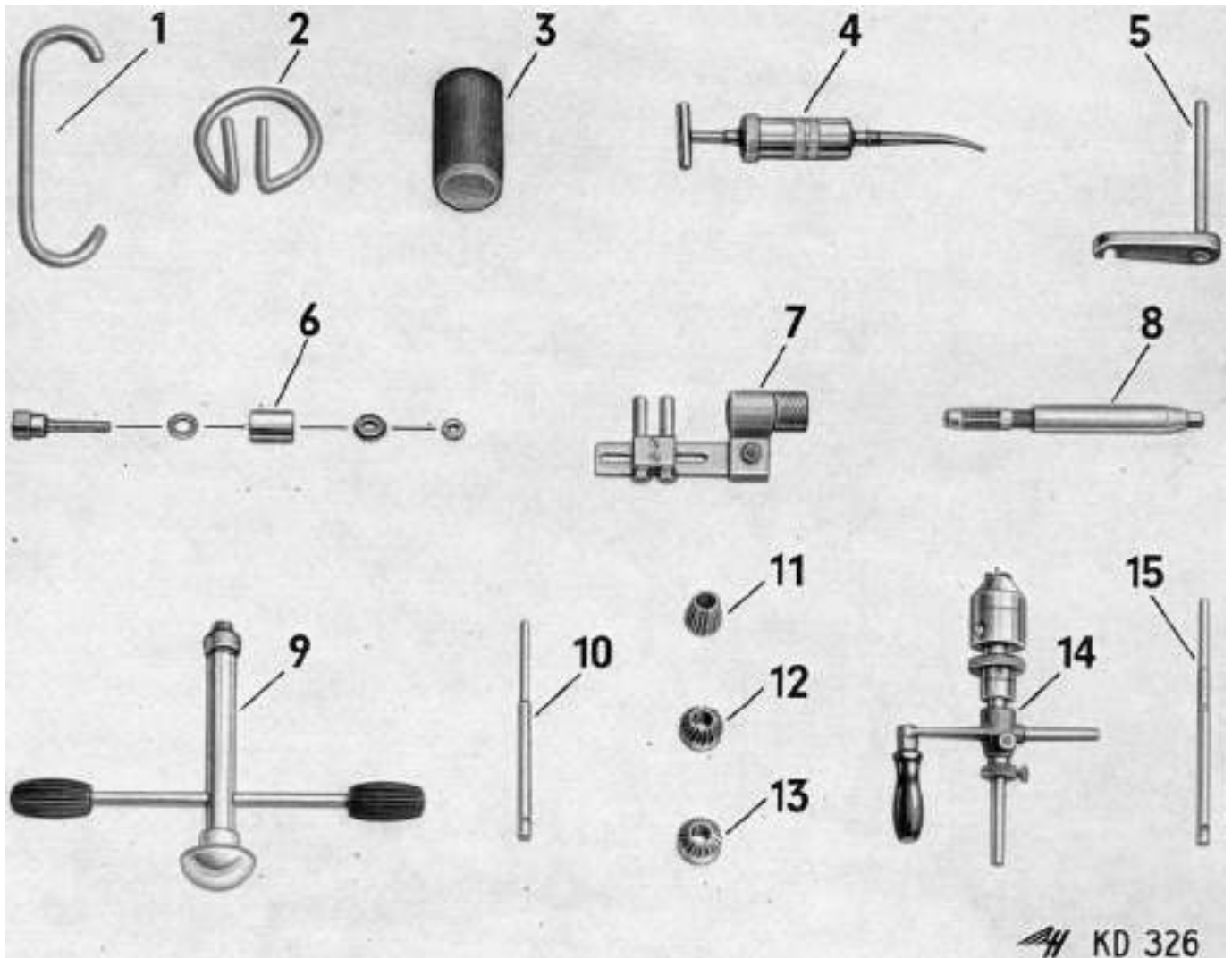

3 Special Tools

Key to illustration above:

No.	Drawing No.	Description
1	self-made	Retainer for exhaust silencer
2	self-made	Retainer for Engine
3	self-made	Wooden punch for frame ball-races
4	commercial type	Grease gun
5	407/W 37	Retainer for brake plate
6	self-made	Extractor and refitter for connecting rod bushes
7	commercial type	Reamer guide
8	commercial type	Reamer for connecting rod bushes
9	commercial type	Holder for hand milling cutter
10	commercial type	Pilot for hand milling cutter
11	commercial type	Milling cutter 29 mm diam. 77.5°
12	commercial type	Milling cutter 32 mm diam. 45.0°
13	commercial type	Milling cutter 32 mm diam. 30.0°
14	commercial type	Cutter for adjusting valve seating
15	commercial type	Guide for cutter for adjusting valve seating

General Data

In order to facilitate repair work on the scooter frame we recommend using an assembly jig (fig. 4, drawing on page 52) which can be made by the dealer in his own workshop. The same applies to the assembly jig for the engine (fig. 5, drawing on page 53).

When carrying out any major overhaul and/or fitting work on the engine such an assembly jig and corresponding special tools should in all cases be used.

Prior to carrying out repair work the vehicle should be cleaned most thoroughly. After having been cleaned, the removed components should be checked, for wear and tear, and, if necessary, be replaced. Worn and damaged components should be exchanged for

Genuine HEINKEL Exchange Parts or

Genuine HEINKEL Spare Parts.

In order to fit correctly all moving parts, such as ball bearings, shafts, axles, bushings, radial gaskets, pistons etc. should be lubricated. To obviate leakage renew all gaskets, cleanse face surfaces of the housings (housing halves) and seal with securing lacquer all threads on parts that are in contact with oil.

All HEINKEL-Spares should be ordered by HEINKEL-Owners from the HEINKEL-dealers and/or distributors, and not direct from the HEINKEL factory. Overseas HEINKEL dealers order HEINKEL spares from the distributors or from the importers. Only the importer may order the spares direct from the HEINKEL factory in Western Germany, or distributors direct, with the importer's authorization.

When ordering, the order should specify

1. name and address of ordering firm
2. mode of despatch requested
3. frame and engine number of vehicle involved
4. correct specification (nomenclature) of spare parts requested and drawing number.
5. Quantity ordered.

Dismantling and reassembling the engine

Raise the vehicle and, with the central stand set up, place it on the jig. Place the two pegs of the cross-member into the two middle holes provided on the gusset plate of the scooter frame, fix frame tube on jig cross-member by means of screwing clamp, fix central stand of scooter by means of clamping clip.

1. Remove spare wheel and spare wheel carrier. Raise the seat cushion from the middle section. Take out the leads to the braking and licence plate light at the socket plug. Undo two hex. bolts for the pipe clamps, open the side flap and remove the rear coachwok.
2. Undo and disconnect battery cable. Remove the battery.
3. Undo and remove the leads which lead to the engine at the governor and at the ignition coil. Remove the governor switch.
4. Close the fuel cock, disconnect the fuel line at the carburettor; remove fuel tank. (Also remove rubber cushions beneath fuel tank.)
5. Undo air filter locking screw and remove air filter, take off carburettor.

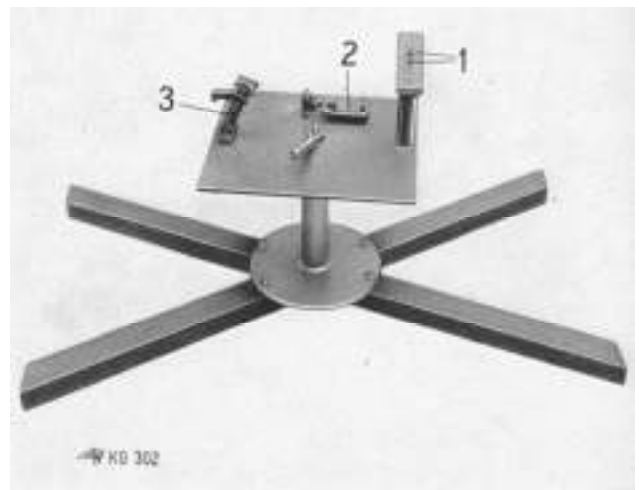

4 Scooter frame assembly jig

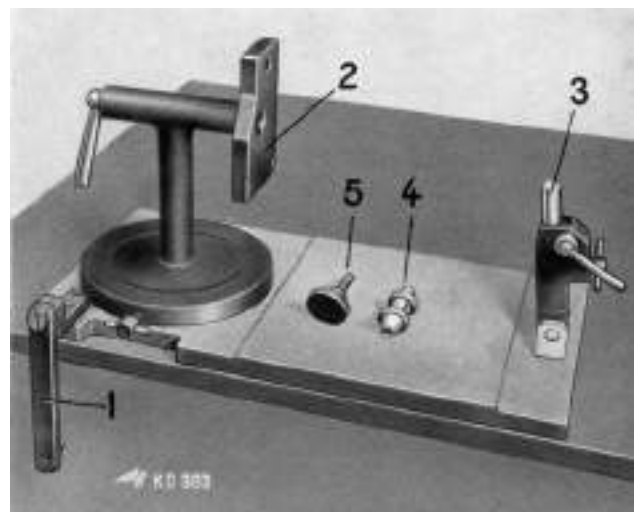

5 Assembly jig for scooter engine

6. Remove exhaust silencer and air outlet pipe.

Please note:

Avoid stress when fitting exhaust silencer as otherwise exhaust manifold might break!

7. Undo four nuts on the rear wheel and remove the rear wheel. Undo fixing bolts and nuts on the spring leg and remove spring leg.

Please note:

When fitting the rear wheel, tighten wheel nuts at 6.0 mkg. Insert upper fixing bolt of spring leg from inside!

8. Disengage rear wheel brake cable from the brake lever and unscrew the brake cable set-screw from the support on the swinging arm.
9. Disconnect the clutch control cable from the clutch lever. Unscrew adjusting screw.
10. Undo cylinder screw on the shift lever and push lever off gear selector. (Do not damage rubber ring!) Remove adjusting screw for the clutch cable from the support on the clutch cover.

Please note:

When fitting the shift lever, the marks on the gear selector and the shift lever have to correspond. Grease both rubber sleeves on the switch cable by grease gun.

11. Undo the hex. nuts of the rubber elements for engine suspension with a box spanner, push back hex. bolts (Box spanner SW 17.)
12. Loosen hex. bolt (SW 17) of clamp (right-hand side) (this makes engine removal easier).
13. Lift the engine with swinging arm out to the rear, as shown on fig. 6. It would be advantageous to use retaining jig 6/1

If further repair work is to be carried out on the engine, undo two hex. nuts with box spanner (SW 15), remove internal toothed disc and clamp for engine suspension. Fix engine on flange 5/2 of engine assembly jig by means of knurled screw 5/5 and special nut 5/4. When engine in horizontal position, use piece 5/3 for support and fix fan wheel and armature by means of retaining jig 5/1.

Reverse the procedure when reassembling.

Please note:

For connecting electric cables, proceed in accordance with wiring diagram, page 50.

When fitting Genuine HEINKEL Exchange Engine, check oil level. If necessary, fill in oil of well-known brand, such as e.g. Mobil Oil Special.

Prior to operating, change Micronic filter insert.



6 Lifting the engine out

Engine

Dismantling of cylinder head, cylinder and piston

Please note:

If you wish to carry out the above mentioned repair work, do not remove the engine; just proceed as per page 9, "Dismantling and Reassembling of Engine", paragraphs 1, 4, 5 and 6. (However, please bear in mind that this applies **only** to the above repair work!):

1. Undo the nuts on the cylinder head cover with box spanner (SW 10), remove air-vent hose and cylinder head cover. Remove cooling baffles, dismantle induction and exhaust manifolds.
2. Unscrew and remove spark plug. Place piston at t.d.c. with valves closed and loosen clamp nuts 7/1 and nuts for rocker arm shafts-Cover push rod channel with clean rag. Undo two nuts (SW 10) on rocker arm and slightly loosen the ball-shaped screw for valve setting, so that the rocker arm shafts 7/2 can be pushed out of their Journals with a pin without forcing. Take off rockers 7/3 (and the spacing washers) and remove push rods.
3. Using box spanner (SW 14), undo cylinder head fixing nuts 7/4 and take off cylinder head and cylinder. (Watch out for the soft-iron washers, since these have to be used again when re-assembling).
4. For better dismantling of the piston, use the forked retainer plate (401/W 20) 8/1. Cover crank case with a piece of clean rag. With a pair of pointed pliers, remove both wire snap rings from the piston. Push out the piston gudgeon pin with gudgeon pin extractor (401/W 26) 8/2 and remove piston.

Please note:

To avoid bending the connecting rod, on no account knock the gudgeon pin out.

5. To strip the engine completely, undo nuts 7/5 and take off the bracket.

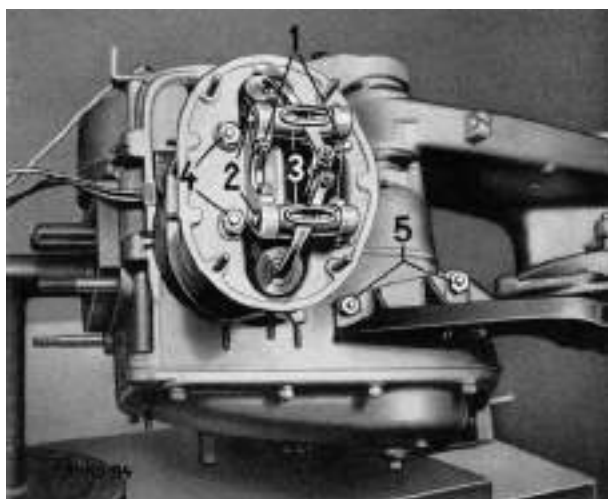

7 Cylinder head with rocker arms

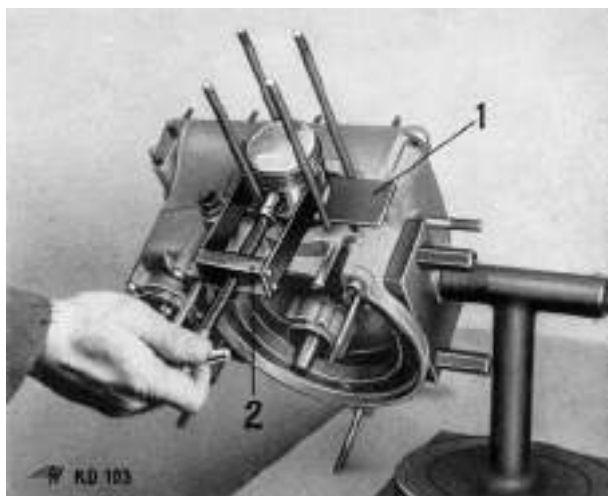

8 Dismantling the piston

Reassembling piston, cylinder and cylinder head

1. Tighten tie rod for cylinder (3 mkg). To obtain safe sealing, wipe tie rod on crank case with sealing lacquer.
2. Lay on to the crankcase the cylinder foot gasket (dry) and the forked retaining piece (401/W 20) 9/1.
3. Fit the wire snap ring for the piston gudgeon pin in the piston. Place the piston on connecting rod, insert the gudgeon pin into piston and connecting rod bush as far as the wire snap ring, holding the piston tightly with the left hand. Cover crank case with a clean rag.
4. Insert the wire snap ring with a pair of pointed pliers. Make sure, by twisting them, that the snap rings are properly seated.
5. Oil the working surfaces of the cylinder and also the piston. Twist the piston rings, so that the gaps are not all facing in the same direction.
6. Using the piston ring tightener (407/W 20) 9/2, squeeze the piston rings together, fit the cylinder and lower carefully over the piston. Remove piston ring tightener and forked retaining piece (401/W 20).

Please note:

When using oversize cylinder and piston, the corresponding measurements will be found listed on Genuine HEINKEL Exchange Cylinders. (See Page 18.)

7. Lay on cylinder head gasket (dry) and fit cylinder head. Lay on washers 12/3 and wipe stay bolts with sealing lacquer. Using the tension wrench, secure cylinder head by alternately tightening diagonally-opposite bolts. (3 mkg). Once nuts 10/4 have been tightened, seal with sealing lacquer.
8. Move crankshaft by rotating fan wheel and set piston at its top dead center. Fit push rods and make sure that they are all set at the same height. Fit rocker arms 10/3. To center rocker arms, insert guide pin (401/W 19) 11/1 into bearing blocks and rocker arms. If there should happen to be a relatively large lateral play between rocker arm and bearing blocks, eliminate it by fitting spacing shims, drawing number 408.300-014 (0.4 mm.), 408.300-015 (0.3 mm.), 408.300-016 (0.2 mm.).

Please note:

If a lateral play of rocker arms of up to 0.4 mm. is found, those spacing shims are to be inserted on the pressure side (i.e. on the side opposite to the push rods). If said play exceeds 0.4 mm., those spacing shims are to be inserted on both sides of the rocker arm.

9. Fit shaft 11/2, tighten clamping screws 10/1 for rocker arm shafts.
10. Adjust the valves (see page 13).
11. Screw in sparking plug. Fit induction and exhaust manifolds and gaskets.
12. Lay on cylinder head cover gasket and fit cylinder head cover. Fit cooling baffles and air outlet hose.
13. For further assembly, reverse the procedure as outlined, under "Dismantling the Engine - Reassembling the Engine", page 9, paragraphs 6, 5,4 and 1.



9 Fitting the cylinder

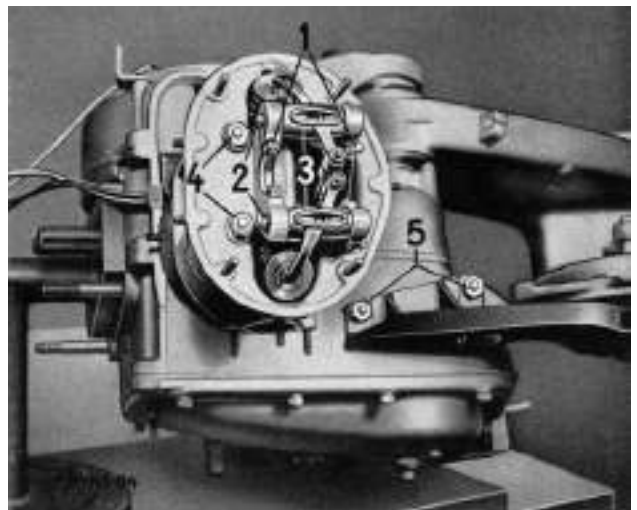

10 Cylinder head with rocker arms

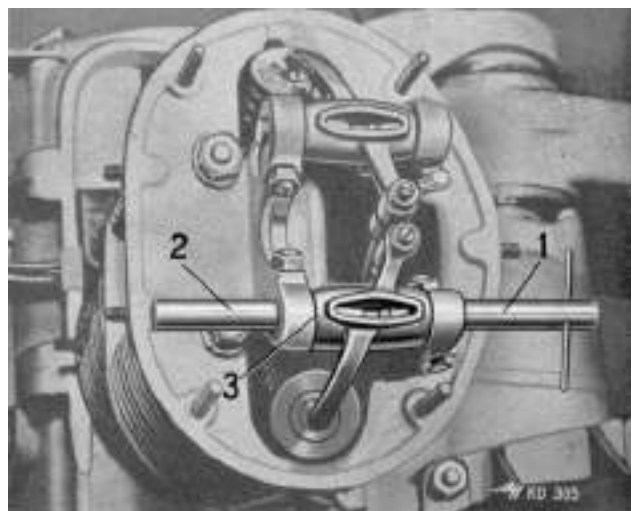

11 Fitting rocker arm shafts

Adjusting the valves

Please note:

Remove spare wheel and spare wheel carrier. Raise seat cushion on middle section of rear cowling. Disconnect at plug the cables for braking and rear licence plate light. Undo two hex. nuts for pipe clamp. Remove rear cowling. The valves should only be adjusted while the engine is cold.

1. Undo the nuts on cylinder head cover by using box spanner (SW 10). Remove air-outlet hose and cylinder head cover.
2. Set piston at top dead center position. Both valves must be closed.
3. Adjust the valves. (See fig. 12).
The valve tappet clearances are:
Inlet valve 12/1 0.15 mm.
Exhaust valve 12/2 0.20 mm.
4. Once adjusted, lock the setscrews with nuts.
5. For assembly, the reverse procedure is to be applied.

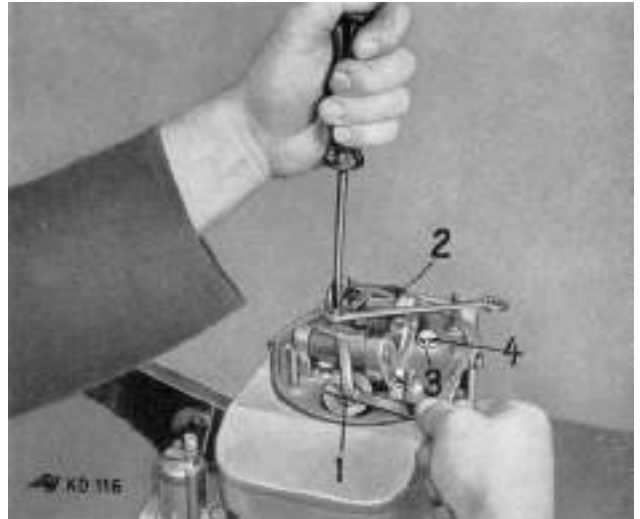

12 Adjusting the valves

Removing and fitting connecting rod bush, reaming out the bush

Please note:

Proceed as outlined on page 11, "dismantling cylinder head, cylinder and piston". Cover crankcase with clean rag.

1. Place and fix retaining jig with guide bush 13/1 on crankcase.
2. Turn both eccentric pins 14/3 on jig against connecting rod and tighten nuts 14/4.
3. Place extractor with spacing pipe. By using two fork spanners (SW 17), screw on nut and extract bush.
4. Mark lubrication hole on new bush. Drill lubrication hole with twist drill 4.5 mm. + 0.5 mm. diam. (at an angle of 90 degrees to bore of connecting rod bush.) Remove burr from inside and outside of bush.
5. Place thus prepared bush on guide pin 13/3.
6. Center bush on top end of connecting rod. Put on guide pin of guide jig and fit nut 13/4.
Insert bush 13/2 by screwing on nut, using two fork spanners (SW 17).

Please note:

Lubrication holes of bush and top end of connecting rod must correspond. Check alignment by using wire or needle.

7. Remove retaining jig with guide bush, undo nuts and turn both eccentric pins away from connecting rod.
8. Center connecting rod 14/5 by using conical part 14/2 of the reamer.
9. Turn both eccentric pins on jig against connecting rod and tighten nuts.

Please note:

Prior to tightening, make sure by feel that the connecting rod has not been tilted.

10. Loosen both adjusting nuts (SW 16) 14/6 on the reamer. Adjust the cutters 14/7 to required diameter and then tighten adjusting nuts again.
11. Insert reamer into connecting rod bush and slowly but continuously ream out the bush, constantly pressing forward. (Use tap wrench or spanner.)



13 Inserting connecting rod bush

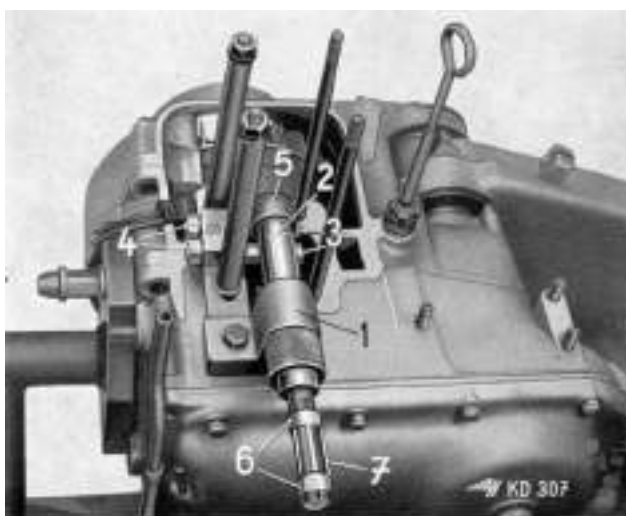

14 Centering connecting rod bush

Permissible tolerances

Colour marks	Ø mm	hole for piston gudgeon	piston gudgeon	connecting rod bush
White	18	+ 0.003 + 0.0005	0 - 0.0025	+ 0.0425
Black	18	+ 0.0005 - 0.002	- 0.0025 - 0.005	+ 0.0275 + 0.0450

Dismantle and assemble cylinder head, grind in valves

Please note:

Proceed first as per page 11, "Dismantling the Cylinder head, cylinder and piston, paragraphs 1, 2 and 3 (without removing cylinder).

1. Place cylinder head onto jig (see fig. 15). Push lever and thus compress valve springs, remove the conical valve cotters. Remove upper and lower spring plates, also remove external and internal valve springs.
2. Clean cylinder head and remove oil carbon deposits.
3. Place cylinder head onto jig (see fig. 16) and fix by means of retaining bolt 16/5.
4. Using a hand-milling cutter 16/4 mill inserted valve seats. Use
guide pin 7 mm. \varnothing + 0,013 mm.
+ 0,028 mm.
 - a) mill the channel, using cutter 29 mm. \varnothing . 77.5°, 16/2.
 - b) mill the inserted valve seat, using cutter 32 mm. \varnothing 45.0°, 16/3.
 - c) mill the valve-bearing section of the inserted valve seat, using cutter 32 mm. \varnothing , 30.0°, 16/1.

Inserted valve seats can also be milled by means of the "HUNGER"-Milling Tool for Inserted Valve Seats.

5. Place cylinder head 17/2 onto jig 17/1 and fix.
6. Firmly insert guide pin 17/3, using no lubricant, into the cleaned valve guide.
7. Using hand-milling cutter, 29 mm. \varnothing , 77,5°, 16/2, mill the channel.
8. Place on guide pin 17/3 the Milling Tool for Inserted Valve Seats (slightly lubricate the top section of guide pin before). Loosen fixing screw 17/5, while maintaining in position the Milling Tool to prevent the cutter tip 17/6 damaging the valve seat.
9. Using fork spanner (SW 7), loosen lock nut 17/7 and adjust the Rapid-Action Regulator 17/8 so that the cutter tip is positioned in the middle of the valve seat.
10. Tighten set-screw 17/5.
11. Turn rapid-action regulator 17/8 anti-clockwise until cutter tip 17/6 is positioned at approx. 1 mm distance from the internal edge of the valve seat.
12. Tighten lock nut 17/7.
13. Maintain annular support 17/9 in position while turning the crank 17/4 in direction indicated by arrow in fig. 17 until all of the valve-bearing section is being milled until the cutter will run idle.

Please note:

If by the above procedure the valve seat has not been smoothly milled (smooth surface!), proceed as follows:

14. Loosen lock nut 17/7, turn anti-clockwise rapid-action regulator 17/8 so that the cutter tip is positioned at approx. 1 mm. distance from the internal edge of the valve seat. Tighten lock nut.
15. Loosen knurled screw 17/10 and turn milling regulator 17/11 to the left (as indicated by arrow on fig. 17) by one line mark. Tighten knurled screw again.

Please note:

1 line mark of the calibration about equals 0.1 mm.

16. Proceed as outlined under paragraph 13 above.
17. As after carrying out the above procedure the valve seat has been milled smoothly (smooth surface!), proceed to finish-mill. For this purpose, leave milling operator in same position. Only operate rapid-action regulator 17/7 and 17/8 (see paragraph 14) and repeat procedure as outlined in paragraph 13.



15 Dismantling cylinder head

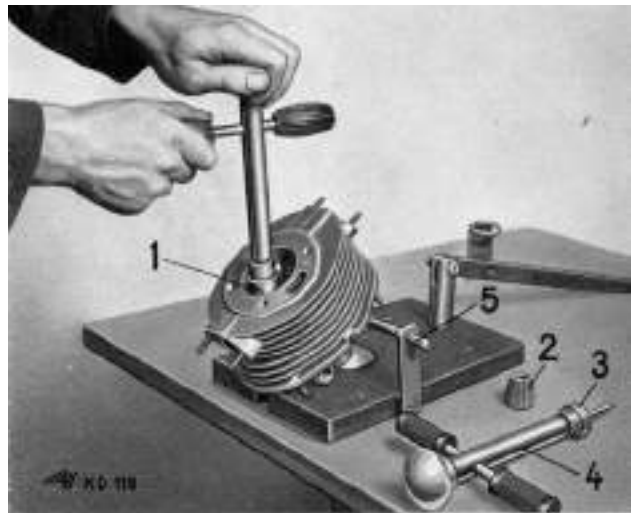

16 Hand-milling valve seats

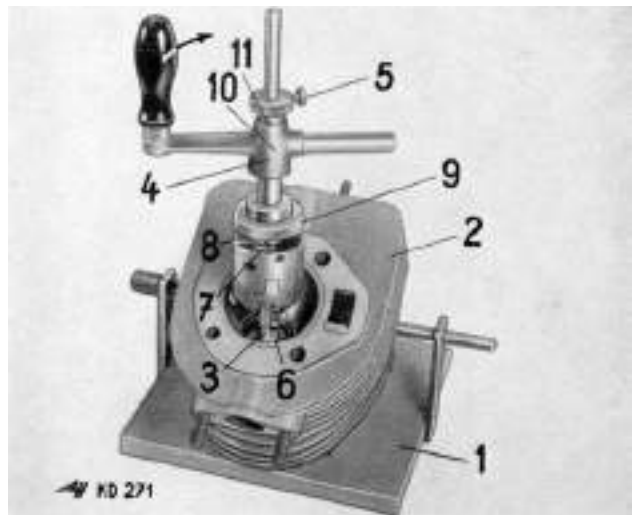

17 Milling valve seats, using special milling tool

18. Remove Milling Tool for Inserted Valve Seats.
19. Using hand-milling tool 32 mm Ø 30.0° 16/1, mill the valve-bearing section of the valve seat. Remove guide pin.

Please note:

Widths of the valve-bearing sections of the valve seats
 Inlet valve 1.1-1.2 mm
 Exhaust valve 1.5 mm

20. Using a fine-grade grinding paste, grind the valves until all of the bearing sections of valves and valve seats (on cylinder head and valves) show a uniformly grey shine without any bright grooves.
21. After grinding, clean valves and cylinder head.
22. Check that valve-seats have been thoroughly finished by using engineers' marking blue.
23. Insert valves in cylinder head. Using depthmeter 18/1, measure distance between top surface of the valve stem 18/2 and the milled surface 18/3. (Support of lower spring plate.)

Please note:

This distance - for pre-tension of the spring - has to be:
 for inlet valve 31.0-31.8 mm.
 for exhaust valve 31.5-32.3 mm.

24. Compensate possible tolerances by using spacing discs (shims), drawing number 404.300-005 (0.2 mm), 404.300-006 (0.5 mm.), 404.300-007 (1.0 mm.). Those spacing shims are to be placed beneath the lower spring plate.
25. Insert valves and place cylinder head onto jig (see fig. 15).
26. Lay on lower spring plate (if necessary, also lay on spacing shims), internal and external valve springs and the top spring plate. Compress lever of jig and thus compress valve springs; insert conical valve cotters.

Please note:

The external valve spring, when in released position, has a total length of 30.5 mm. Under 6.9 kg. pressure its length has to be 27.0 mm., under 20.0 kg. pressure 20.3 mm.

The internal valve spring, when in released position, has a total length of 26.5 mm.. Under 3.4 kg. pressure its length has to be 23.0 mm., under 10.0 kg. pressure 16.3 mm.

Having fitted the valves, it is recommended to apply a few tap hammer strokes on the end of the valve stem, using a plastic or a rubber hammer, thus smoothening the valve seat sections and obtaining perfect seating.

It is recommended, besides, to pour some petrol into the valve ports to ascertain, by having a look at the bottom side of the cylinder head, that the valves are a perfect fit.

Use an Exchange Cylinder Head if valve guides are so worn as

to exceed 7 mm. Ø + 0.013 mm.
 + 0.028 mm.

and/or if valve seat rings are very worn.

27. For further assembly, reverse the procedure as explained under "Reassembling the Cylinder Head, Cylinder and Piston", page 12, paragraphs 7, 8 etc.

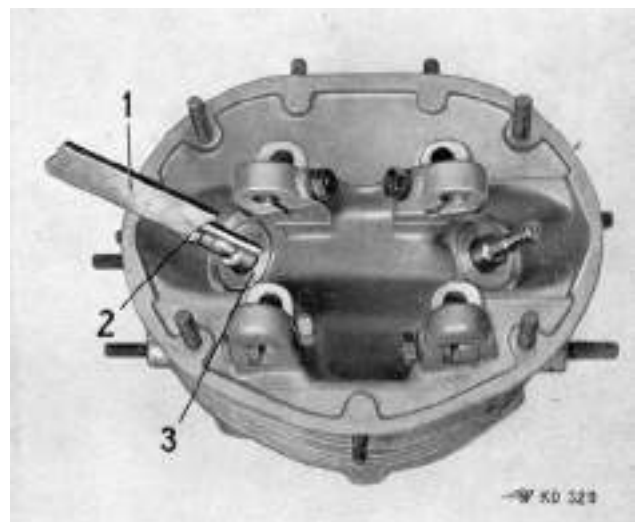

18 Measuring spring pre-tension

Check piston and cylinder

Please note:

Proceed as explained on page 11, "Dismantling Cylinder Head, Cylinder and Piston".

Cover the crankcase with a clean rag.

When refitting a used piston, remove all traces of oil carbon from the piston head and the cylinder, take care that the piston is fitted in the same direction as before (i.e. front to front).

1. Check piston (i.e. surface of contact) for grooves, traces of piston seizures, worn spots (light grey surface!); check piston rings for burns.
2. Using a feeler gauge 19/1, check the height play of the piston rings, the permissible tolerance between the piston ring and the ring groove being:

Ring Groove	Piston Ring	Minimum	Maximum
I	Compression ring (chromium)	0.060 mm.	0.090 mm.
II	Compression ring	0.035 mm.	0.070 mm.
III	Oil scraper ring	0.025 mm.	0.060 mm.

3. To check piston rings for gap, singly place one ring 20/1 at a time in the foot of the cylinder and press flat with the skirt of the piston. Check gap of each individual ring by using feeler gauge 20/2. Said play is not to exceed 0.40 mm.

Please note:

If the wear of the cylinder bore (ovality!) still lies within permissible tolerances (0.10 mm.), new piston rings may be fitted to the piston. If not, the cylinder and the piston have to be exchanged.

4. By using a commercial-type cleaning tool or a section of the piston ring, thoroughly and cautiously clean the ring grooves; the grooves are, however, not to be enlarged thereby.
5. Fit the piston rings, taking care that the manufacturers' markings are turned towards the piston head. The rings must be easily turnable in their grooves.

Please note:

If fitting a new piston and gudgeon, take care that the colour markings coincide. (See page 14). Those coloured dots are to be found a) on the inside of the gudgeon pin boss on the piston, b) on the end face of the gudgeon pin.

6. Clean the cylinder, remove all traces of oil carbon.
7. Check cylinder bore for grooves and spots of seizure.
8. Assess exact amount of wear on the cylinder; Insert cylinder meter 21/1 in the bore of the cylinder, so that the feeler and the guide pin 21/2 slide on the bearing surfaces of the cylinder. Measure the cylinder bearing surface at at least 3 different spots: at top dead centre, in the middle, at approx. 10 mm. from the foot of the cylinder.

Please note:

The internal measuring gauge is to be adjusted, prior to its application, to the "ORIGINAL" diameter, this adjustment being carried out with the aid of a gauge ring or a micrometer. (See Table of Original and Oversize groups on page 18). Should the wear exceed the adjusted ORIGINAL size by 0.15 mm. or more, the cylinder and the piston have to be exchanged.



19 Testing the height play

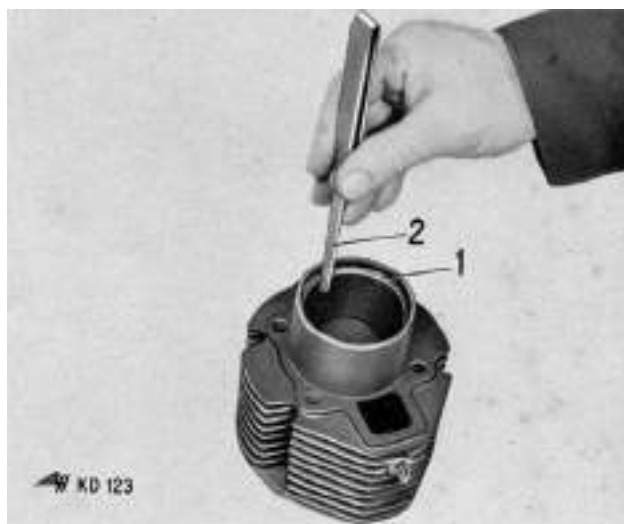

20 Testing the gap

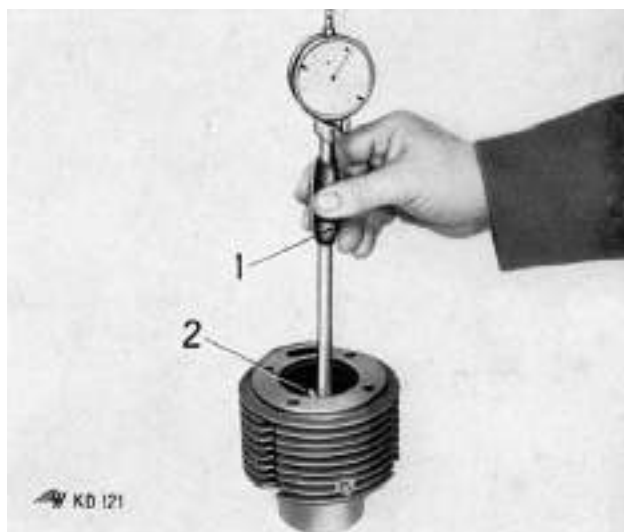

21 Measuring the cylinder

Please note:

Size groups are marked on the cylinders of new HEINKEL vehicles, these marks are to be found opposite to the push rod channel.

Size groups of new vehicles are marked opposite to the push rod channel, size groups of oversize cylinders on the left- and/or right-hand side of the cylinder top.

9. For further assembly proceed as explained under "Reassembling of Piston, Cylinder and Cylinder Head", page 12, paragraphs 1-12.

Table for original and oversize groups

Cylinder				Piston			
normal	New vehicles		Oversize		Size Groups	Tolerance	
	Y	X	W				
60.0 Ø				0	0 - 0.010	59.94 Ø	
				1	0 + 0.010	59.95 Ø	
				2	+ 0.010 + 0.020	59.96 Ø	
				3	+ 0.020 + 0.030	59.97 Ø	
	60.1 Ø			0	0 - 0.010	60.04 Ø	
				1	0 + 0.010	60.05 Ø	
				2	+ 0.010 + 0.020	60.06 Ø	
				3	+ 0.020 + 0.030	60.07 Ø	
		60.5 Ø		0	0 - 0.010	60.44 Ø	
				1	0 + 0.010	60.45 Ø	
				2	+ 0.010 + 0.020	60.46 Ø	
				3	+ 0.020 + 0.030	60.47 Ø	
			61.0 Ø	0	0 - 0.010	60.94 Ø	
				1	0 + 0.010	60.95 Ø	
				2	+ 0.010 + 0.020	60.96 Ø	
				3	+ 0.020 + 0.030	60.97 Ø	

Dismantling the clutch

Please note:

Repairs to the clutch can be carried out without the engine being removed. The procedure is set out on Page 9, paragraphs 1, 9 and 10. ("Dismantling the Engine, Reassembling the engine").

1. Undo hex. screw (SE 10) 22/1 for pipe clip, turn cooling air exhaust pipe upwards by 90 degrees.
2. Undo hex. screw (SW 17) for bracket and remove bracket 23/1.
3. Drain off the engine oil at the oil drain plug (SW 17) 23/2.
4. Disconnect gear control cable and remove rubber hoses. Unscrew the set-screws for gear control cable from its support on the clutch cover.
5. Undo clamping screw 23/3 on the shift-lever 23/7 and remove the gear lever. (Watch for the rubber ring!)
6. Remove rubber ring.
Undo nut (SW 14) 23/4, disconnect spring, remove clutch lever. Turn the clutch pin screw 23/5 to the right so that the clutch worm 31/2 screws out.
7. Undo lock-nuts 23/6 from the clutch cover and remove clutch cover. Remove spring retaining bracket. (Watch out for the soft-iron washers, these can be used again).
8. Apply the clutch compressor (401/W 25) 24/1 and compress the clutch. Remove the wire snap-ring 24/3 with a screwdriver (watch out!!), loosen the compressor tool. Take off annular spring support, remove springs and clutch plates (for assembly watch for proper sequence of individual plates). Remove clutch pin, lift-off ring with ball race.
Remove wire snap ring from clutch insert by applying screw driver (watch out!) and take off end separator clutch plate. Remove control segment 24/2.

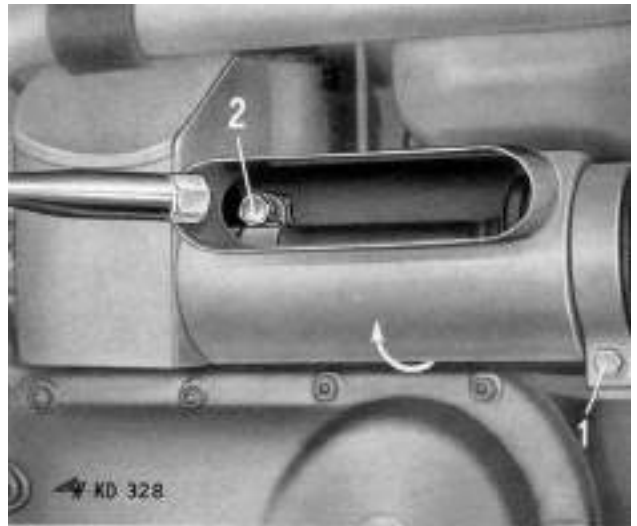

22 Remove cooling air exhaust pipe and exhaust silencer

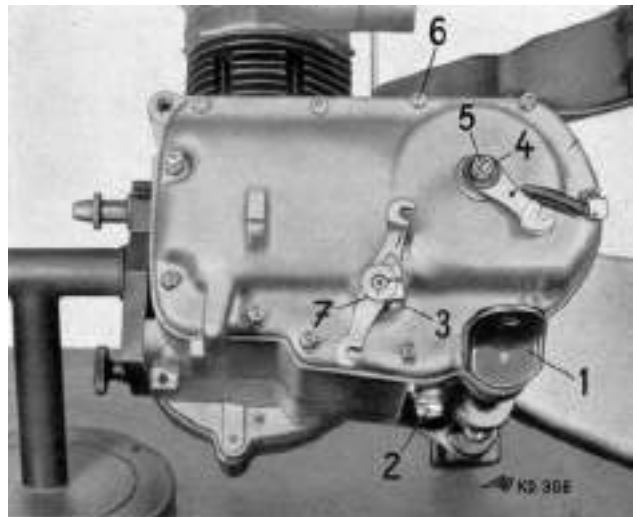

23 Clutch cover with gear and clutch levers

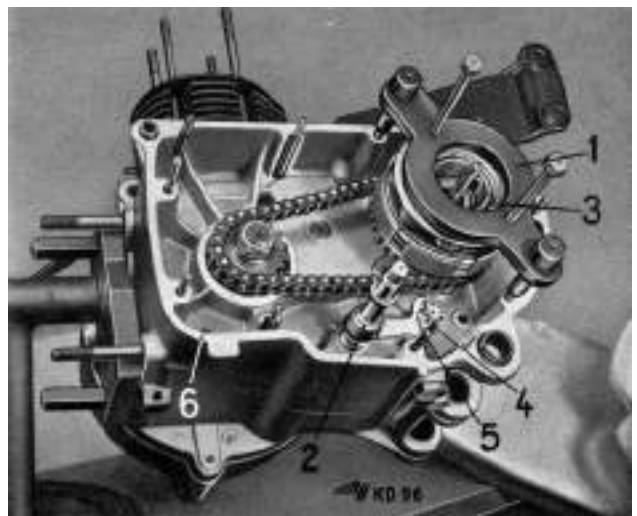

24 Removing clutch by using compression tool

9. Insert Clutch Retaining Jig (408/W 14) 25/1 into the recesses of the clutch housing. (Bolt in the housing serving as fixing point). Using socket spanner 25/2 (SW 22), undo hex. nut on clutch insert, using socket spanner (SW 24) undo hex. nut for left-hand crankshaft end 25/4. Remove the small chain wheel and clutch basket with chain.
10. Remove the backing washer (clutch) from clutch spindle and the spacing washer from the left-hand crankshaft end.

To be noted:

Between the small chain wheel and the ball-bearing there might in addition to the spacer ring of the crankshaft, be shims to compensate the play of the chain.

(For reassembly, if re-using former chain, take care that same retains former direction of course; if using a replacement chain, watch for chain to bear colour marking coinciding with marking of former one.)

If, when the engine is dismantled, it is desired to dismantle the rear wheel brake, then proceed as follows: Remove rubber cap 25/3, take out the cotter pin. Insert the retaining jig (407/W 37) 25/5 into the bore (fixing for spring leg) on the swinging arm. Fasten rear wheel hub by fixing jig claw to bolt. Using socket spanner (SW 24), undo castle nut and remove hub.

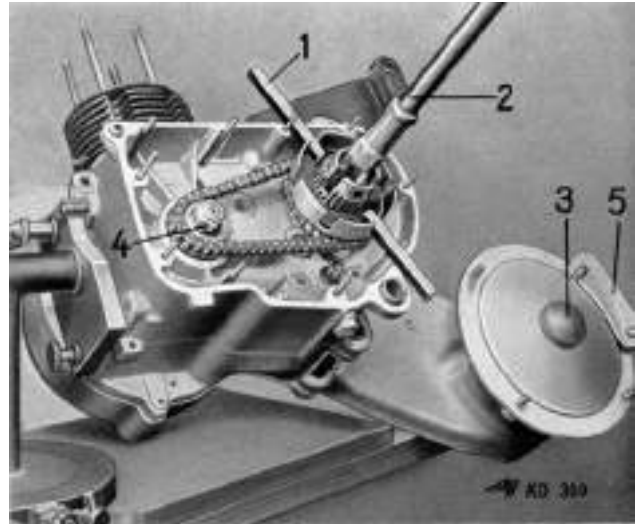

25 Removing clutch insert, clutch basket and chain

Fitting the clutch

1. Place one backing washer on the clutch spindle and one spacer on the left-hand crankshaft end.
2. Place small chain wheel on left-hand crankshaft end. (Collar facing towards spacer).
3. Lubricate clutch interior, insert into clutch basket 26/2 and together put on clutch spindle. The alignment of the chain can be tested with a square 26/1.

Please note:

Any possible tolerances can be compensated by the insertion of shims 26/3 (drawing number 407.400-009) between the chain wheel on the left-hand crankshaft end and the spacer (butting ring).

The difference in alignment between small chain wheel and chain wheel of the clutch basket may not exceed 0.2 mm.

4. After having properly aligned the chain, remove chain wheel and clutch basket.
5. Place chain on small chain wheel and chain wheel of clutch basket and refit together with clutch interior. (Take care that colour markings coincide and chain retains former direction of course.)
6. Fit spring washer over clutch spindle to clutch interior, fit bevelled disc over left-hand crankshaft end to small chain wheel.
7. Apply clutch retainer (408/W 14) 27/1 by inserting it into the recesses of the clutch basket. (Bolt on housing serving for fixing; using torque-metering spanner 27/2, tighten nut (SW 22) and lock nut (SW 24) 27/4. (10 mkg. [98 Nm] each.)
8. Fit the clutch discs, in proper sequence, as follows: end disc, wire snap ring, outer disc, inner disc, outer disc, inner disc, outer disc, lift-off ring with thrust-bearing and clutch pin, end disc, spring seat with springs.

Please note:

When in released position, the compression spring has an overall length of 28.0 mm. At 7,5 kg. pressure spring overall length must still be 20.0 mm. If springs are weaker, this can be compensated by insertion of shims (8.4 mm. diam.) between spring and spring base.

9. Apply Clutch Compression Jig (401/W 25) 28/1 and compress clutch.
10. To fix the retaining ring 28/2, apply the conical lower portion of the fitting tool (401/W 21) 28/3, place the wire snap ring 28/2 in position and, by applying a blow to the upper portion 28/4, force the ring into the groove on the clutch interior. Remove fitting tool and compression jig.
11. Fit the shift segment 30/2. See that the mark 30/5 conforms to the two lines on the control roller 30/4.

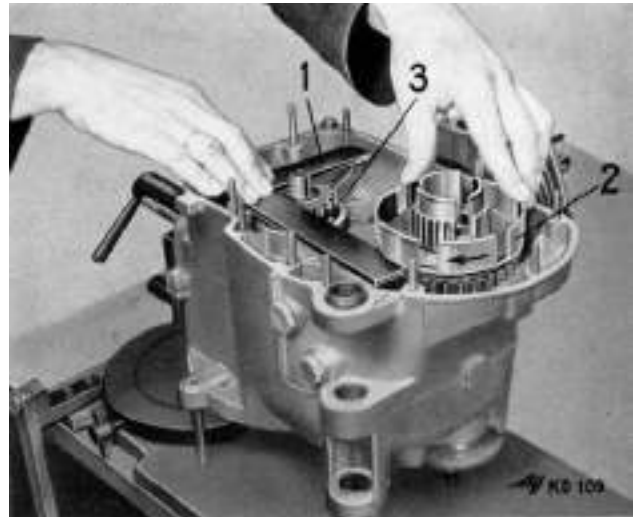

26 Measuring chain alignment

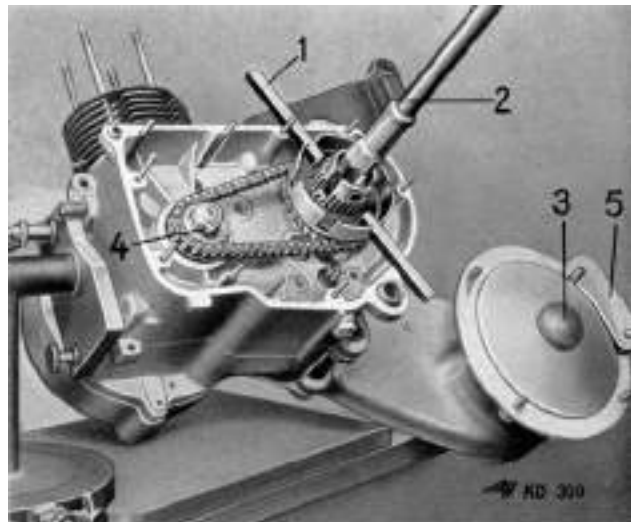

27 Fitting of clutch interior, clutch basket and chain



28 Fitting the clutch

12. Clean the face surface of the crankcase, smear it with grease to encourage better adhesion of the gasket for the clutch cover, then fit gasket. 29/3.
13. Fit assembly sleeve (407/W 29) 29/1 over the clutch pin, and assembly sleeve (407/W 30) 29/2 over the shift segment, fit the clutch cover with built-in radial gasket for shift segment, and rubber cap fitted for clutch pin.
14. Put sealing lacquer on grub screws. Lay on soft-iron washers and clutch spring support. Tighten lock nuts 31/1 crosswise with but 0,8 mkg. tension, as otherwise damage to the clutch cover might result.
15. Check lateral play on the spindle of the shift segment 30/2; there must be a discernible lateral play of 0.2 mm.
16. Insert clutch worm 31/2, the surfaces for the clutch lever being vertical 31/3 and the start of the threaded portion of the clutch worm agreeing with the start of the threaded portion of the clutch cover.
17. Screw the clutch pin 32/5 to the left, turning the worm 29/3 sufficiently far in for the threaded portion of the clutch worm to finish flush with the clutch cover.
18. Fit the clutch lever, disc and spring ring. Tighten nut 32/4, connect return spring with clutch lever and spring support.

Please note:

With this setting, the clutch lever, as shown on Fig. 32, can be easily moved in the direction of lock nut 31/1, then, however, shows resistance. To adjust lever, loosen nut 32/4 and then turn clutch pin 32/5 toward left- or right-hand side.

19. Place rubber ring over spindle of shift segment as far as to clutch cover. Press the shift lever 31/4 perpendicularly on to the toothed portion. Markings 31/5 on shift lever and shift segment must conform. Secure the shift lever by fillister-head screw (31/6).
20. Screw in oil drain plug (with magnetic plug) (SW 17) 32/2.
21. Remove lid (oil filler plug) on cylinder head cover and fill in 1.5 litres of engine oil, such as "Mobiloil Special". Fit and screw plug again.
22. Connect gear control cable, see page 46.
23. Adjust gear control, see page 46.
24. Connect clutch control cable and adjust, see page 46.
25. Fit bracket with hex. screw (SW 17).
26. Turn cooling air exhaust pipe by 90 degrees toward the ground and fit hex. screw (SW 10) 22/1 for pipe clamp bracket.
27. For further assembly, reverse procedure as explained on page 9, "Dismantling the engine, Reassembling the engine", paragraph 1.

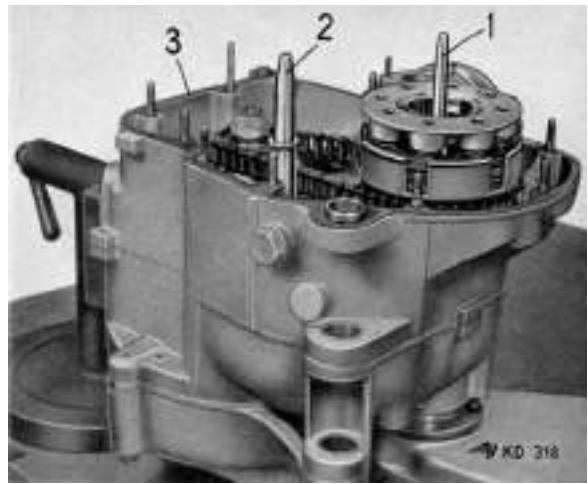

29 Assembly sleeves for clutch pin and shift segment

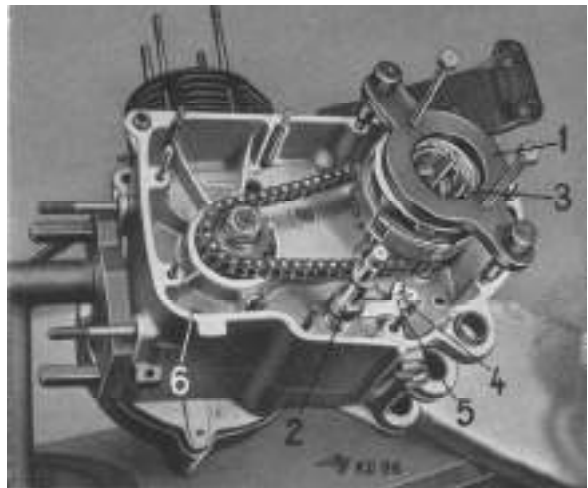

30 Adjusting the shift segment

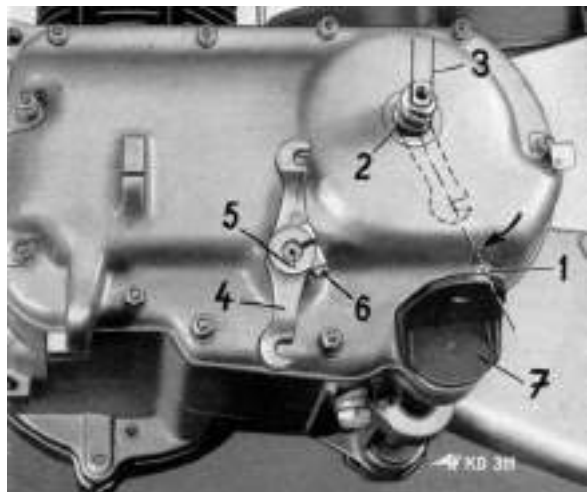

31 Inserting the clutch worm

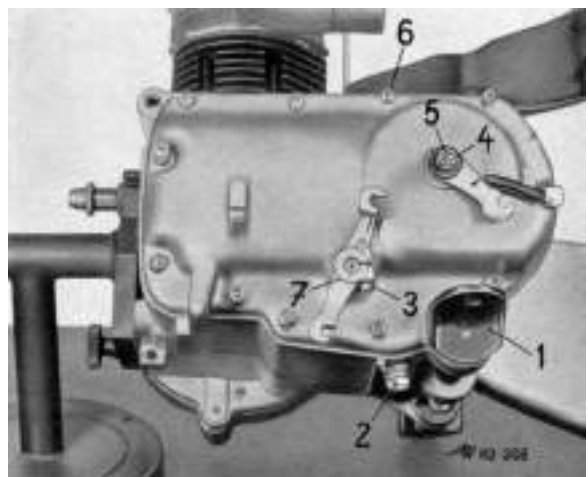

32 Fitting the clutch cover

Dismantling the Dynamo

Please note:

When repairing the dynamo, remove the engine. Proceed as explained on page 9, "Dismantling the engine, Reassembling the engine", paragraphs 1 to 13.

1. Undo hex. screw (SW 17) for bracket clamp (right-hand side) and remove clamp.
2. Take off the contact breaker cover plate. (Watch out for the gasket, as this can be used again). Undo the two slot-headed screws; take off the contact breaker plate.
3. Using socket spanner (SW 10), screw off nuts 33/1, 33/3 and the three nuts 33/2 (SW 14), remove fan housing.
4. Apply the retaining arm of the jig (401/W 9) to the fan wheel and lock the latter. Take off the four cheese-head screws 34/2, remove cover plate and fan wheel.
5. Screw off two fillister-head screws 35/1 and remove the centrifugal governor.

Please note:

To change the contact breaker cam, remove the disc. Lift off spacer and Novotex (plastic) disc and take off cam.

6. Apply the retaining arm of jig (401/W 9) 34/1 or jig (407/W 21) 2/10 (using the two bores on the armature) and undo screw (SW17)39/3.
Remove disc and spring washer.

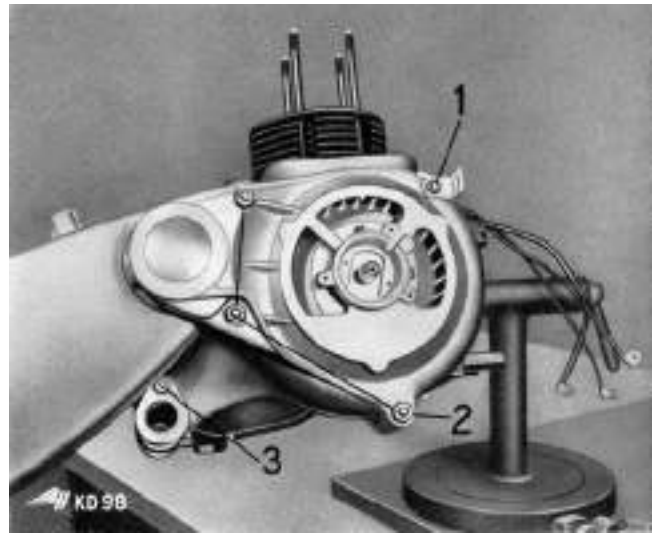

33 Removing the fan houses

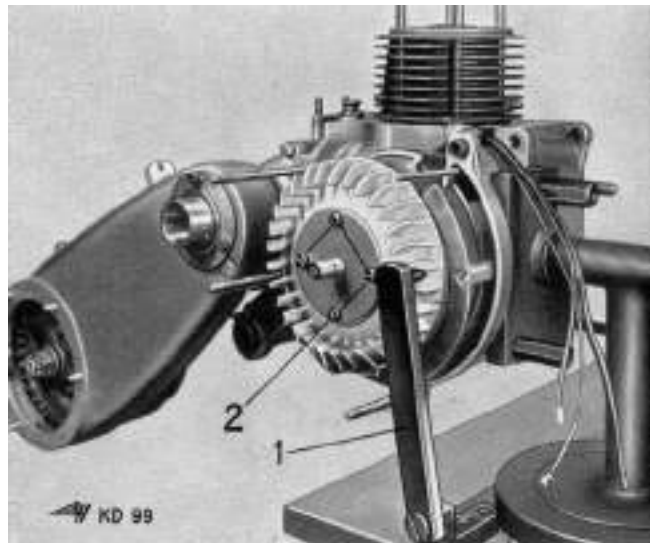

34 Locking the fan wheel

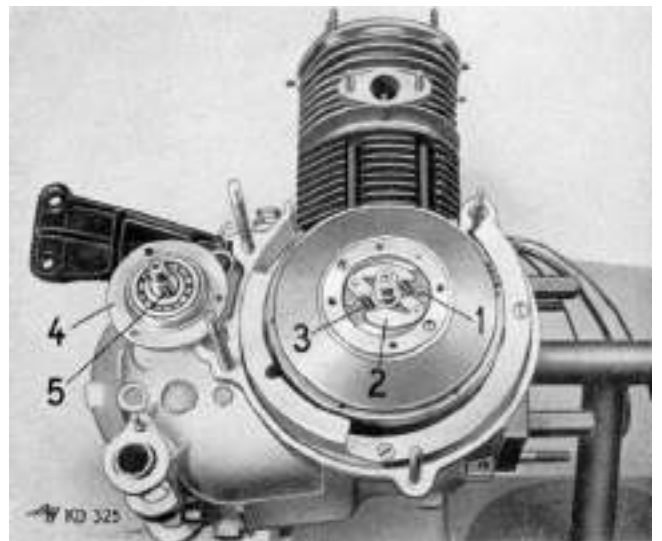

35 Centrifugal governor

7. Replace (without tightening) screw 39/3. Screw in the extractor tool (404/W 7) 36/1 and, using forked spanner SW 27 36/2 as a counterholder, push off the armature. Remove screw 39/3, withdraw armature.
8. Undo the three hollow-headed screws (SW 6) 38/1 holding the magneto system. Remove this latter, watching out for the radial gasket.
9. Take out the three countersunk screws 37/1 and remove the spiral.
10. Remove spring from shaft.

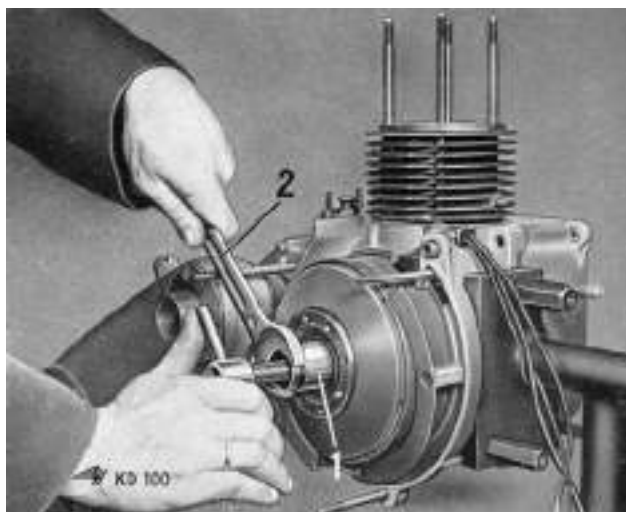

36 Taking off the armature

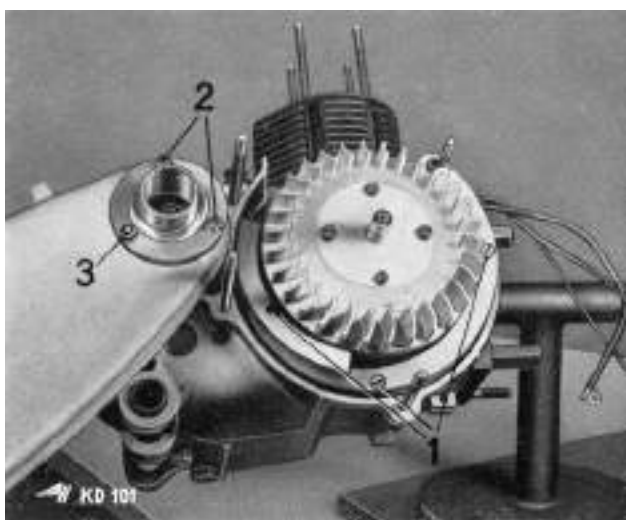

37 Removing the spiral

Assembling the Dynamo

Please note:

First clean magneto system and armature by applying jet of compressed air, remove residues of carbon brushes. Cleanse by rinsing in washing petrol and dry at once. Do not leave parts for too long a time in petrol rinsing bath as otherwise same might soak and burn when later on in operation. When fitting the magneto system, the cable passages (rubber) 38/4 of the dynamo cables must be perfectly fitted in the recesses provided therefore on the crankcase. (Danger of short-circuits).

1. Using three hollow-headed screws, fix the magneto system.
2. Insert the carbon brushes 38/2 (free from grease) and tighten up three slot-headed screws 38/3.
3. Place plate spring in right-hand crankshaft end.
4. Rinse crankshaft axle (taper) with Tri or some other de-greasing liquid.
5. Fit armature (taper free from grease) screw in hex. screw with spring washer and disc.
6. Using torque wrench (SW 17), tighten hex. screw 39/3 (10 K). By alternately applying gentle taps (with plastic or rubber hammer) to the armature and repeatedly tightening, increase torque to 6.5 mm.
7. Insert centrifugal governor in the groove of the armature and secure with two slot-headed screws 40/1. Connect the two springs 40/3.
8. Using three countersunk screws 37/1, fit spiral, place fan wheel and cover plate. Using 4 fillister-headed screws 34/2, secure fan wheel and cover plate. Use jig (401/W 9) 34/1 as counterholder.
9. Insert the rubber sealing ring with grease in the swing arm mounting.
10. Fit fan housing, secure it with three screws (SW 14) 41/2 and spring washers, nut (SW 10) 41/1 and spring washers, lock nut 41/3 with sealing ring (smear threads with sealing compound).

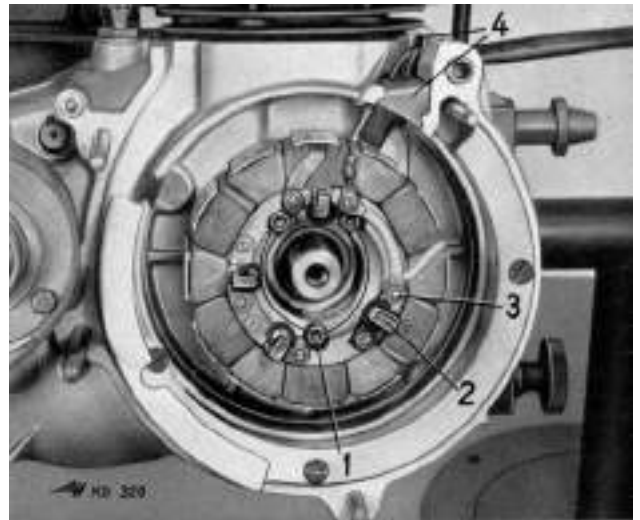

38 Magneto system

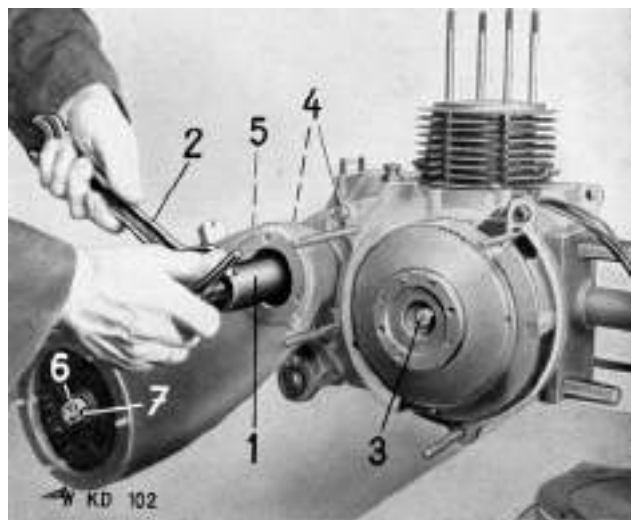

39 Armature, Screw 10 K

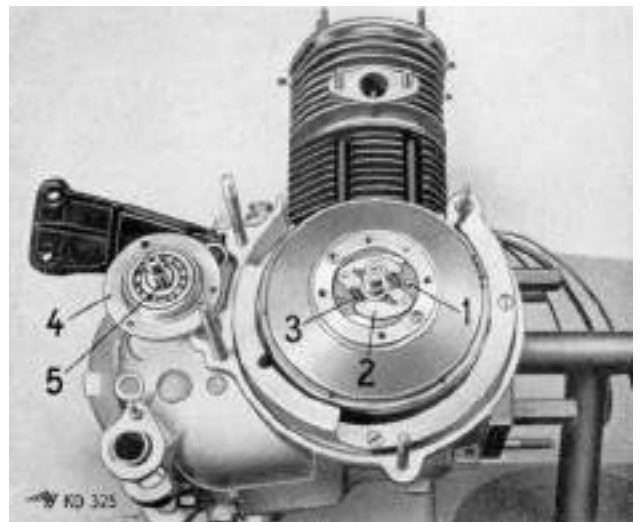

40 Centrifugal governor

11. Insert gasket, felt holder and felt washer.
12. Check for wear the contact breaker plate 42/1 (contacts and plastic transmitter), check contact breaker cam axle 42/2 for tight fit, check contact breaker spring 43/3 for spring tension.

Please note:

If contacts worn, exchange contact breaker lever and contact supports.

13. Using screw-driver, unscrew fillister-head screw 42/4 and remove contact supports.
14. Undo nut (SW 7) for connection lead and spring.
15. Take off spring clip 42/5 and buffer disc, remove contact breaker lever. For refitting, reverse above procedure.

Please note:

When closed, the contacts have to make contact with all of their face surfaces. If necessary, readjust contacts. Should lateral play be found on the contact breaker lever, adjust same by inserting shims. Grease lubricating felt 42/6 with high-viscosity grease such as BOSCH FT 1 v 4.

16. Check contact breaker for short-circuit to earth.

Please note:

For this test, use a BOSCH Tester 43/1:

17. Insulate contacts with insulating matter (Pertinax, Mica, Press-board and the like) and close the circuit of the Tester over the Contacts.
18. Apply one test prod 43/3 to the bottom plate (earth) while applying a second prod 43/4 to the soldered spot (connection lead). If now the glow lamp 43/5 of the Tester "lights up", this is proof of a short-circuit to earth.
19. Fit contact breaker plate and connection lead, secure with two slot-headed screws 42/7.
20. Adjust ignition (see page 27).
21. Fit covering plate with three slot-headed screws.
22. Fit clamp bracket with hex. screw (SW 17).
23. For further assembly, reverse procedure as explained on page 9 "Dismantling engine - Reassembling engine", paragraphs 1 to 13.

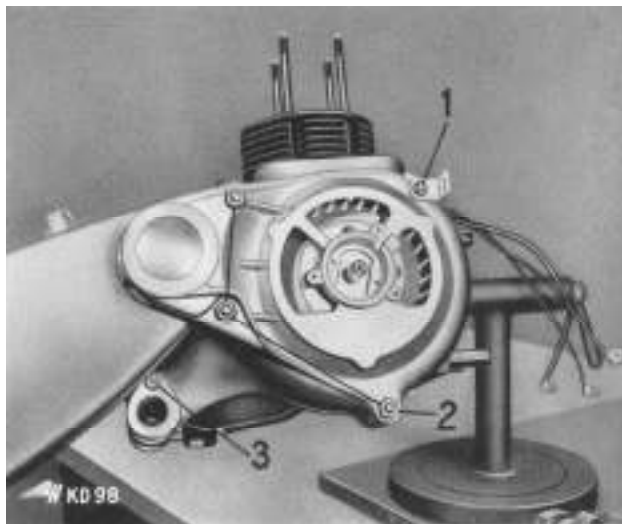

41 Fitting of fan housing

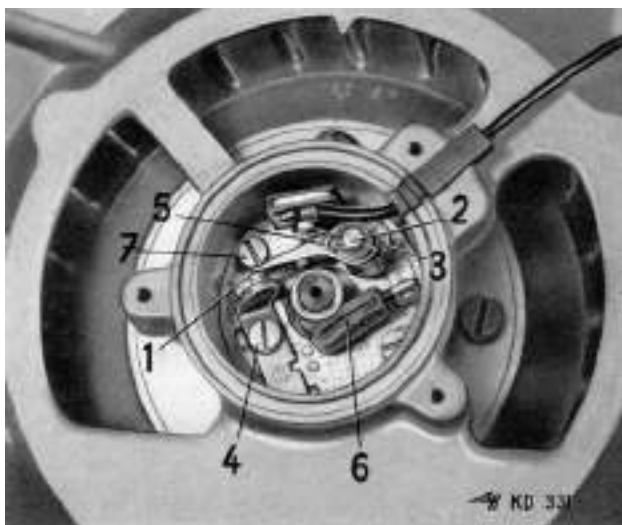

42 Contact breaker

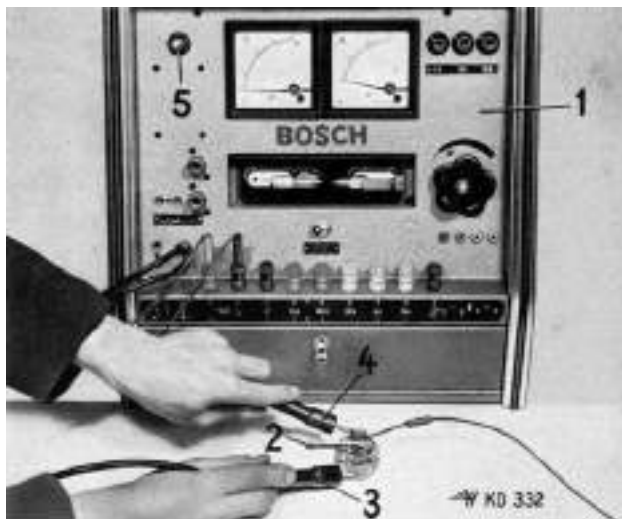

43 Check contact breaker for short-circuit to earth

Adjusting the Ignition

Please note:

Proceed as explained on page 9 "Dismantling the engine - Re-assembling the Engine", paragraph 1.

Before screwing in the Ignition Timer (404/W 10) 2/19, by using a blunt object, clean the oil carbon from the piston top because carbon deposits of this nature can lead to inaccurate measurements being taken.

1. Unscrew the spark plug, and into spark plug thread screw the Ignition Timing Tool (404/W 10) with its meter.
2. Set the contact breaker gap 42/5 to 0.4 mm. when the contact breaker cam is in its uppermost position.
3. Turn the fan wheel right round (see arrow) in the direction of rotation of the engine, marking the top dead centre position with the figure "0" on the meter dial. (Valves closed, maximum pointer deflection.)
4. Turn the fan wheel against the direction of rotation of the engine. Connect pilot light to terminal 1 of the ignition coil and to earth; switch on the ignition.
5. Turn the fan wheel in the direction of rotation of the engine. If the ignition is properly set, the pilot light will "light up" when the piston position is 0.7 mm. before top dead centre.
6. If this adjustment is not attained, bring the piston into a position 0.7 mm. before top dead centre.
7. Undo 2 screws and turn contact breaker plate until light will "light up".
8. Turning the contact breaker plate **against** the direction of rotation of the engine gives **advanced** ignition, while turning it in the direction of rotation of the engine gives **retarded ignition**.

Please note:

Always make sure that the position 0.6—0.8 mm. before t.d.c. is reached when turning in the direction of rotation of the engine, as otherwise the bearing clearances can cause inaccuracies of measurement.

The gap between contact breaker points should be between 0.40 and 0.45 mm.

Adjust ignition timing only whilst on retarded ignition (fly weights not swung out). It amounts to:

0.6—0.8 mm. before t.d.c. measured with timing tool (404/W 10) or 8° —10° before t.d.c.

Advanced ignition takes place with the following setting: 6.5—7.0 mm. before t.d.c. or 33° —35° before t.d.c. (Automatically, owing to the centrifugal governor).

For coarse adjustment purposes, there are three lines marked on the fan wheel and an integrally cast arrow on the fan housing.

Mark: OT 44/1 = Top dead centre

SP 44/2 = retarded ignition

FP 44/3 = advanced ignition

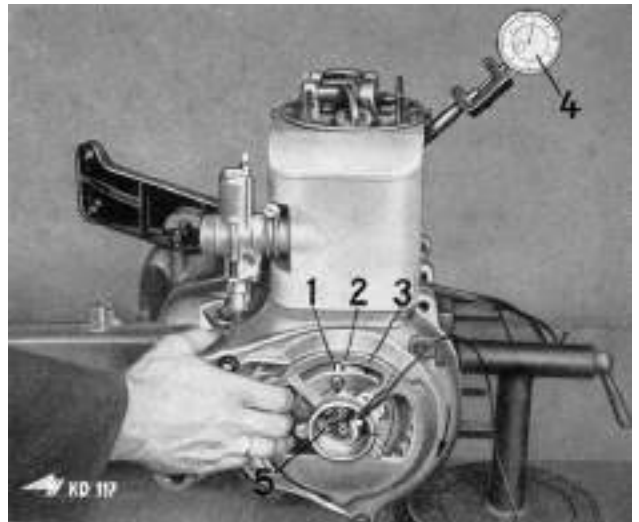

44 Adjusting the ignition

Checking Dynamo and Regulator

Please note:

Proceed as per page 9, "Dismantling the Engine, Reassembling the Engine", paragraph 1.
When working on the electrical equipment, avoid Causing sparks.

Checking the unregulated voltage at the dynamo

Please note:

Use a voltmeter 45/1 (d.c.) with a dial ranging from 0 to 50 volts.
Remove battery screen.

1. Undo leads D + / 61 45/2 (black) and DF 45/3 (black) at the regulator. (Control box.)
2. Connect voltmeter, connecting the positive pole of the instrument with cable D + / 61 and the negative pole with cable DF.
3. Connect lead DF to earth 45/4 (if the pointer deflects in the wrong direction, the polarity should be reversed).
4. Start engine and increase number of revolutions.
5. The pointer of the measuring instrument 45/1 has to rise to 50 volts.
6. The test being completed, refit battery screen and reconnect leads. For further assembly, reverse procedure as explained under "Dismantling the Engine, Reassembling the Engine", page 9, Par. 1.

Checking the regulated voltage at the control box (regulator)

Please note:

Use a voltmeter 46/1 (d.c.) with a dial ranging from 0 to 20 volts.
Do not disconnect any leads. Remove battery screen.

1. Clamp on voltmeter, connecting the positive pole of the instrument with clamping spot D + / 61 46/2 of the regulator and the negative pole with earth 46/3.
2. Start engine, increase number of revolutions and check open circuit voltage as indicated on the instrument dial.
3. The voltage has to be 14—15 volts, with no load (all lamps etc. switched off).
4. Refit battery screen. Then proceed as per "Dismantling the Engine, Reassembling the Engine", page 9, paragraph 1.

Checking the charging current

Please note:

Use an ammeter 47/1 (d.c.) with a dial ranging from 0 to 10 A.

1. Disconnect battery lead 30/51 at the positive pole of the battery.
2. For the sole purpose of starting the engine, the battery cable 30/51 has to be reconnected with the positive pole of the battery, (thus closing the starting circuit).
3. Connect up ammeter, connecting the positive pole of the instrument to the battery lead 30/51 47/2 and the negative pole to the battery clamp 47/3.30/51 47/2.
4. Switch on load (headlamp and rear light).
5. The charging current of the dynamo has to be at least 1 A. (If the pointer deflects in the wrong direction, the polarity should be reversed.)

Attention:

The ammeter must not be connected in the starter circuit while the engine is being started!

If the above mentioned voltage and/or current figures are not attained, the defective parts should be repaired or replaced. It is recommended to have this work carried out by a local BOSCH Service station having at its disposal all the necessary spare parts.

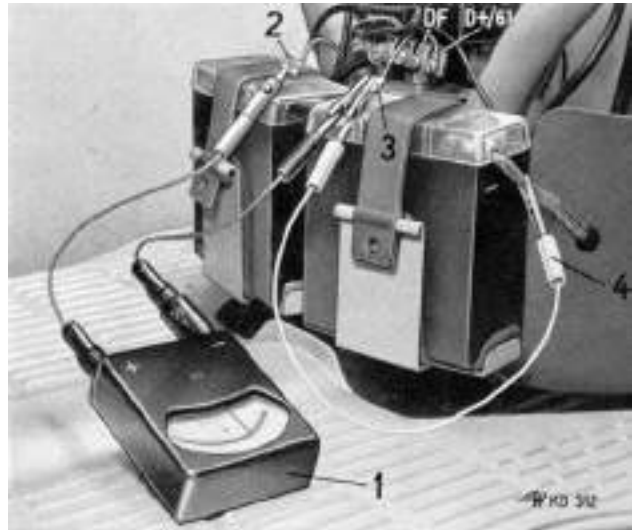

45 Measuring the unregulated voltage of the dynamo

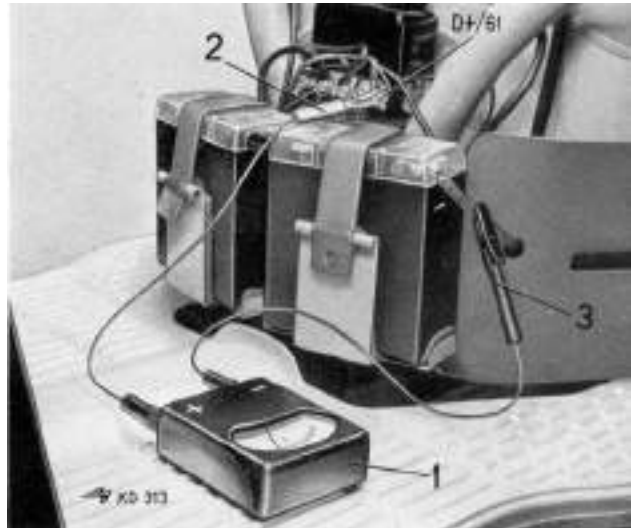

46 Measuring of the regulated voltage

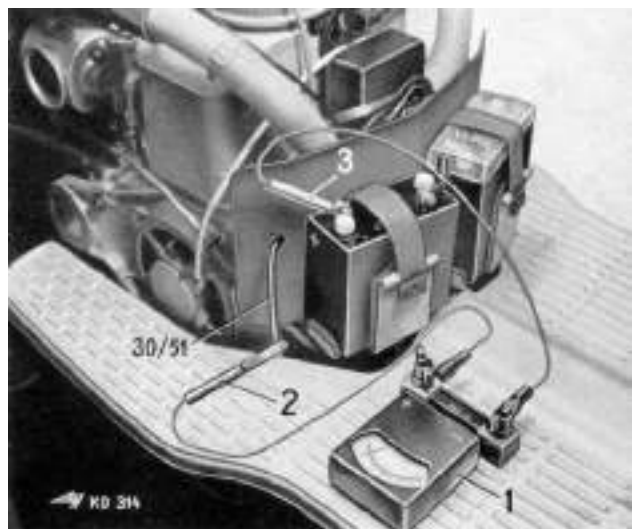

47 Checking the charging current

Dismantling The Swinging Arm

Please note:

For repairs to the swinging arm, please proceed as explained under "Dismantling the Dynamo", page 23, paragraphs 1, 2, 3.

1. Remove 6 hex. nuts (SW 10) with discs, take off swinging arm cover. Remove gasket.
2. Remove rubber protecting cap on brake disc. Take off clips on both sides of rear axle.
3. Insert retainer arm of jig (407/W 37) 27/5 into bore on swinging arm (fixing for spring leg). Lock retainer arm claw on bolt of brake disc; using socket spanner (SW 24), undo both crown nuts and remove brake disc.
4. Using socket spanner (SW 10), undo 2 hex. screws 48/2 and nut 48/3. Remove outer collar bearing.
5. Remove retaining plate for nut 49/4 on small chain wheel.
6. Using socket spanner (SW 19), undo nut 49/4 (left-hand thread!).
7. Apply the extractor tool (401/W 22) 50/1, use the forked spanner (SW 32) 50/2 as a counter holder, and withdraw the chain wheel.
8. Using forked spanner (SW 10), undo the nut 50/5 between the swinging arm mounting and the crank-housing whilst the swinging arm is simultaneously taken off.
9. Remove swinging arm, take off small chain wheel.

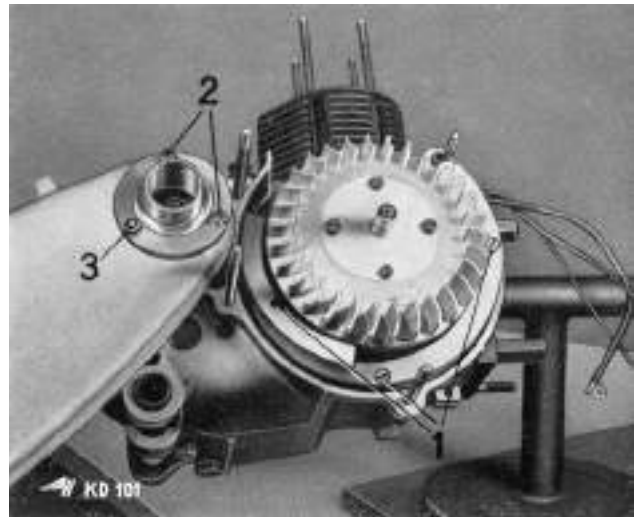

48 Swinging arm mounting

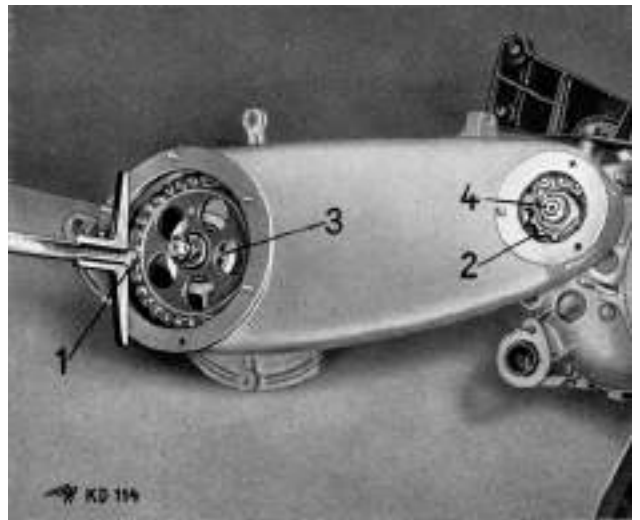

49 Small chain wheel with retaining plate and nut

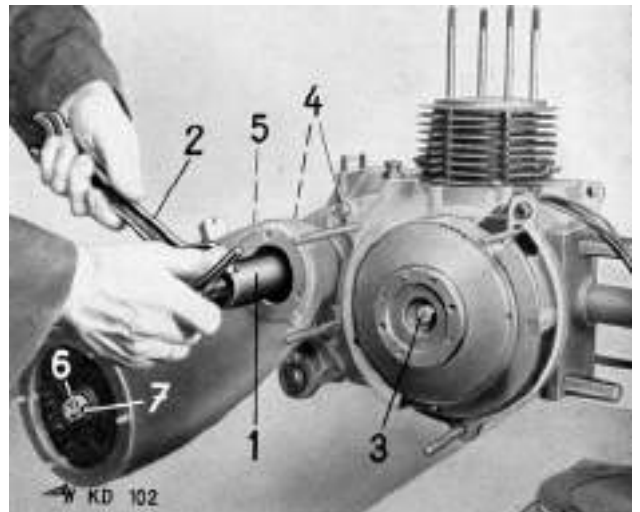

50 Removing the chain wheel

10. Tap the rear wheel axle back (on chain wheel side) until the threaded portion finishes flush with the ball-bearing.
11. Unwind the chain on the large chain wheel and remove the latter with chain.

Please note:

When removing rear wheel, knock out rear axle in direction of brake hub side.

12. Remove radial gasket, Seeger ring, and ball bearing.
13. Knock out ball bearing on large chain wheel side, remove collar bearing.
14. Remove Woodruff key 51/5 from driven shaft.
15. Take off rear collar bearing 51/4 with ball bearing 6303 and radial gasket (oil seal).
16. Remove rubber ring.

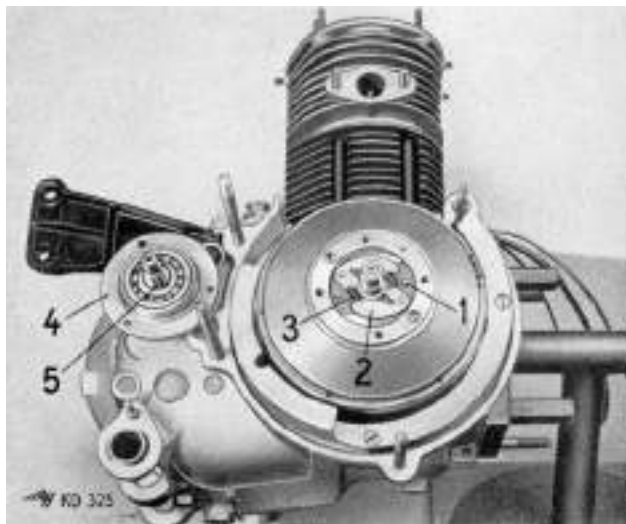

51 Swinging arm mounting, rear collar bearing

Fitting the Swinging Arm

1. Into the groove in the rear swinging arm mounting on the engine housing fit the rubber sealing ring with grease.
2. Lay on rear collar bearing 53/4 with ball bearing 6303 and radial gasket 25x35x7.

Please note:

Packing lug of radial gasket 52/1 must face in the direction of ball bearing 6303, see Fig. 52.

3. Insert plate spring into driven shaft 53/5.
4. Place gasket in position on collar bearing 53/4 (for better adhesion, use grease).
5. Insert Seeger ring on swinging arm (on rear hub side), press in ball bearing 6304, and secure by means of Seeger ring. Press in radial gasket (oil seal) 30x52x 10.
6. Tap the rear axle back (on the brake disc side).
7. Fit Collar bearing on chain wheel side over rear axle as far as ball bearing.
8. Fit ball bearing 6304.
9. Fit chain into swinging arm. (Watch for appropriate running direction of and colour markings on chain!)
10. Fit large chain wheel, fit chain.
11. Place chain wheel with chain mounted onto the toothed portion of rear wheel axle.
12. Screw on crown nut 54/7. Tap the rear axle back in the direction of the brake disc as far as the shoulder of the chain wheel.
13. Fit small chain wheel in the swinging arm fitted with the large chain wheel and the chain.
14. Place the whole swinging arm on rear collar bearing 53/4 and place small chain wheel on driven shaft.
15. Fix nut 54/5 (SW 10) in position between swinging arm and crankcase. Put sealing compound on gasket and nut.
16. Lock fan wheel by means of retaining jig (401/W 9); Put in gear.

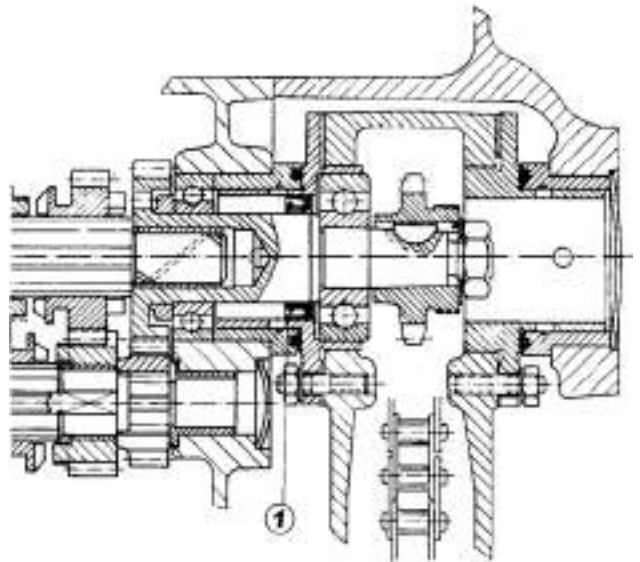

52 Radial gasket for driven shaft

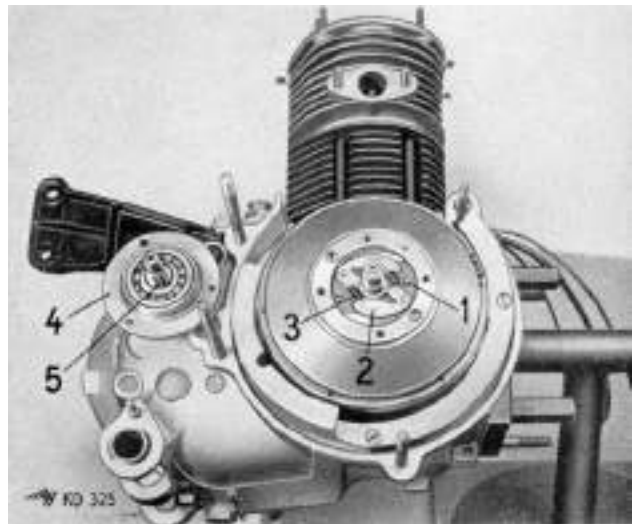

53 Swinging arm mounting, rear collar bearing

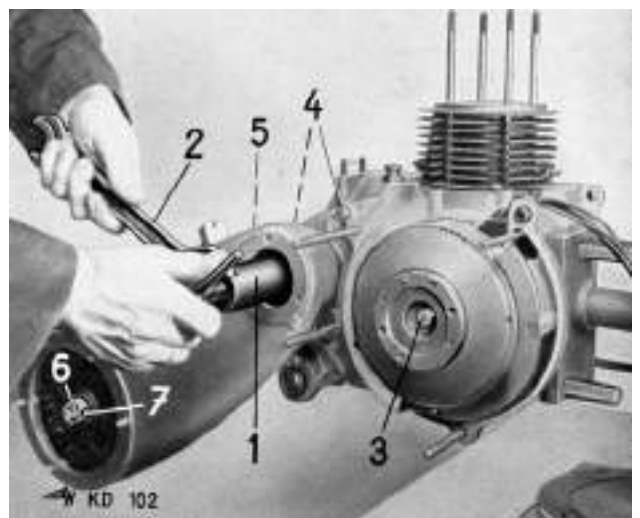

54 Fitting swinging arm

17. Fit Locking washer on small chain wheel 55/2. Using torque wrench (SW. 19), tighten nut 55/4 (left-hand thread!) at 8 mkg [78Nm].
18. Bend Locking washer.
19. Pull out small chain wheel with driven shaft.
20. Measure chain alignment with depth gauge 55/1.

Please note:

The chain alignment should be measured from the machined face for swinging arm cover (without sealing ring) to the milled face of the large chain wheel. Repeat same measuring procedure on small chain wheel.

Any tolerances found can be compensated by shims 55/3 (20x28x0.5) interposed between large chain wheel and ball bearing. The difference in alignment between small chain wheel and large chain wheel should not exceed 0.2 mm.

21. Fit sealing ring (for better adhesion, coat with grease) (small chain-wheel side, on face for outer collar bearing).
22. Using 2 hex. bolts 56/2 (sealing rings) and 1 nut 56/3 (sealing ring), fit outer collar bearing.
23. Into the groove in the rear swinging arm journal housing fit the rubber sealing ring with grease.
24. Fit fan housing and secure with 3 nuts (SW 14) 57/2, spring discs, nut (SW 10) 57/1 and spring disc. Fix in place with locking nut 57/3 (threaded portion to be coated with sealing compound) and sealing ring.
25. Insert spacer and fit brake disc.

Please note:

Insert retaining jig (407/W 37) into the bore on swinging arm (spring leg Fixing!) and lock retainer arm on bolt. Tighten crown nut.

First tighten crown nut 54/7 on large chain wheel and secure by clip 54/6 — then tighten crown nut for brake disc (16 mkg [157 Nm]) and secure by clip.

26. Fit rubber protecting cap.
27. For further assembly, proceed as explained on page 25, "Assembling the Dynamo", paragraphs 10, 20, 21, 22 and 23.

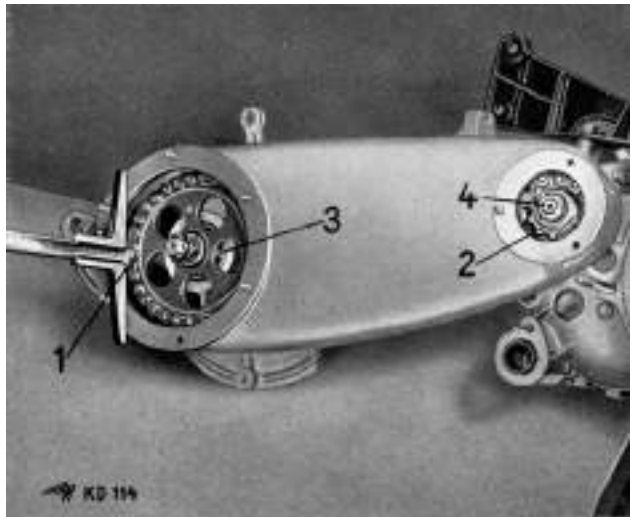

55 Measuring chain alignment

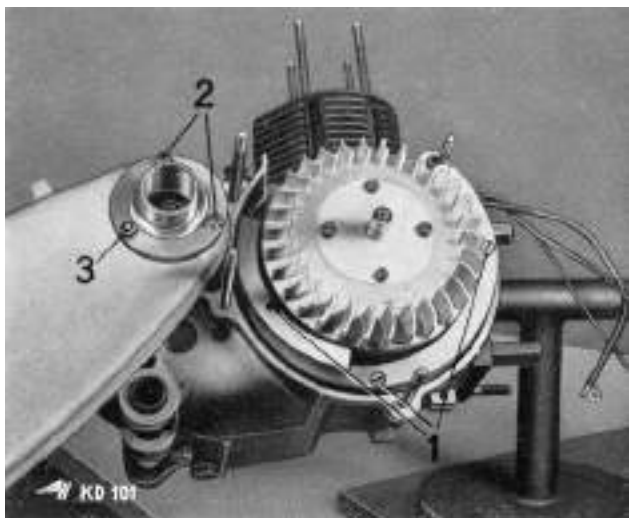

56 Swinging arm mounting



57 Fitting fan housing

Table of Bolts

Fig. 58

Figure	Quantity	Measurements
1	3	M 8x20
2	4	404.100-003
3	1	M 6 X 150
4	1	M 8x70
5	1	M 8 X 100
6	1	M 8x92
7	1	M 6 X 105
8	2	M 6x90

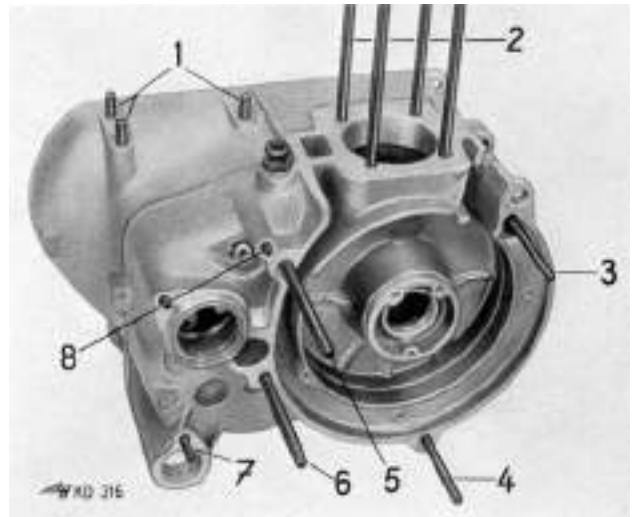
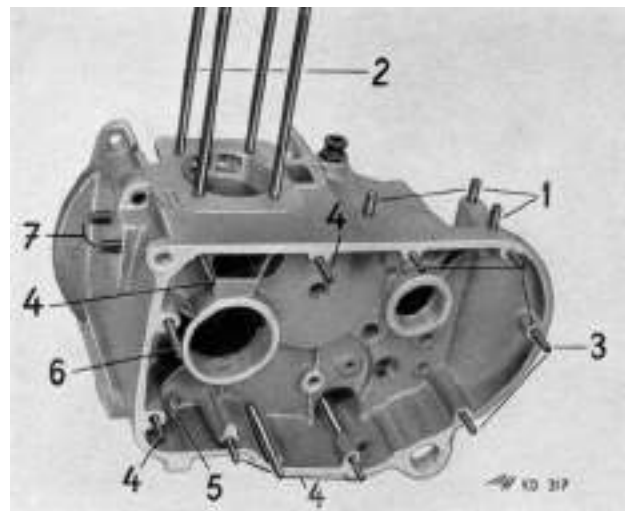

Fig. 59

Figure	Quantity	Measurements
1	3	M 8x20
2	4	404.100-003
3	4	M 6x25
4	6	M 6x115
5	1	M 6x60
6	1	404.100-013
7	2	M 10 X 18

58 Position of bolts, on fan side



59 Position of bolts, on clutch side

Tightening Torques For Bolts and Nuts

	mkg	Nm	lb-ft
crankshaft			
on dynamo side	6.5	64	47
on clutch side	10.0	98	72
cylinder head	3.0	29	22
clutch spindle	10.0	98	72
driven shaft	8.0	78	58
clutch cover	0.8	8	6
rear axle	16.0	157	116
wheel nut			
front	5.5	54	40
rear	6.0	59	43

Kilogram-meter (mkg) : 1 mkg = 9.807 Nm. Kilogram-meter (mkg) : 1 mkg = 7.246 lb-ft.
 Newton meter (Nm) : 1 Nm = 0.738 lb-ft. Pound-foot (lb-ft): 1 lb-ft = 1.356 Nm.

Dismantling Crankshaft And Bearing

Please note:

When carrying out this repair work, proceed as explained on page 9, "Dismantling the Engine, Reassembling the Engine", paragraphs 1 to 13; page 11 "Dismantling the Cylinder Head, Cylinder and Piston", paragraphs 1 to 5; page 19 "Dismantling the clutch", paragraphs 1 to 10; page 23 "Dismantling the Dynamo", paragraphs 1 to 10.

1. Undo the two lock nuts (SW 10) 54/4 with disc on right-hand side of crank-case (dynamo side) and the hex. nut (SW 10) 60/6 with disc on the left-hand side of crankcase.
2. Separate the two halves of the crankcase by gently tapping them with a rubber or plastic hammer.

Please note:

On no account strike the crankshaft. Do not damage faces by using screw driver and the like.

3. Remove small timing sprocket wheel 61/2 and timing sprocket wheel with camshaft.
4. Heat the right-hand half of the crankcase with a hot-plate (do not use a welding torch or any naked flame) to about 175/195° F. Remove crankshaft 61/1.
5. Using ball bearing extractor (407.201/W 5) 62/1 remove ball race 6305 62/2 from crankshaft. If exchanging crankshaft, leave race on crankshaft.
6. If damaged, the radial gasket 25x35x7 of the crankcase half (on dynamo side) is to be pushed out into crank case by means of a punch or a prod.
7. Remove two Seeger rings on left-hand side crankcase half (on clutch side), using special pair of forceps for Seeger ring removal (see Fig. 63).
8. Heat the left-hand side crankcase half on a hot plate to about 80 to 90° C (do not use a welding torch or any naked flame); remove ball bearing 6305.

Please note:

To avoid damaging the crankshaft, use only the necessary special tools, thus safeguarding the exchangeability of the former. Do not place crankshaft into a vice.

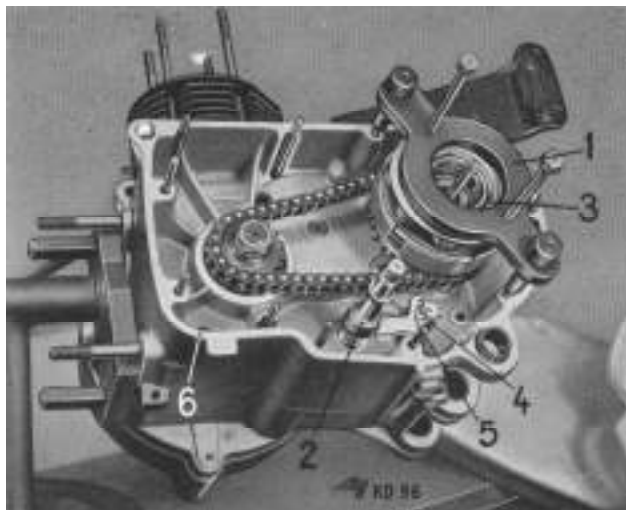

60 Left hand side crankcase half

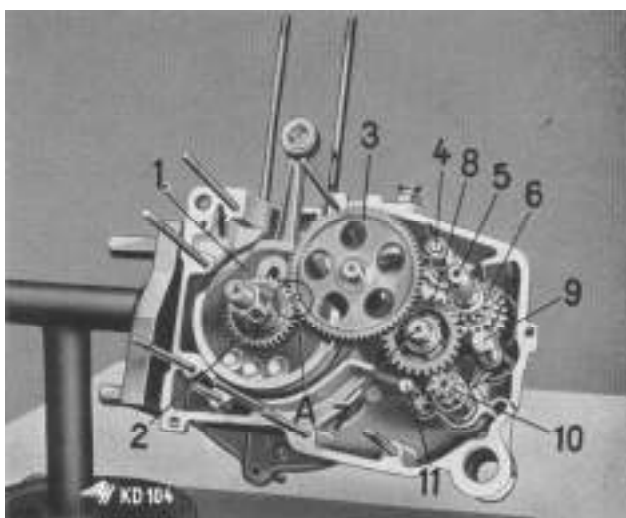

61 Removing timing sprocket wheels and crankshaft

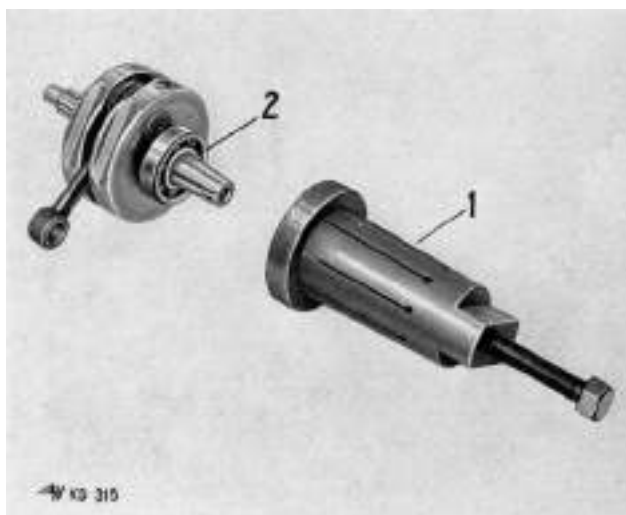

62 Extracting ball bearing

Fitting Crankshaft and bearing

1. Fit Seeger ring 63/1, using special pair of forceps 63/2, into left-hand crankcase housing (clutch side).
2. Heat left-hand housing half on a hot plate (do not use a welding torch or any naked flame) to about 175/195° F.
3. Fit ball bearing 6305 C 3. (Take care not to damage race seat in housing.)
4. Secure ball bearing with Seeger ring.
5. Lay the right-hand crank disc (dynamo side) on the U-shaped plate (recess for the big end) and press in ball bearing 6305 C 3. Original HEINKEL Exchange Crankshafts are supplied with bearings already in pressed-in position.
6. Heat half of crankcase housing (dynamo side!) on a hot-plate to about 175/195° F. (Do not use welding torch or any naked flame.)
7. Using a fitting prod, punch in the radial sealing ring from the dynamo side.
8. Fix the heated crankcase half on the flange of the assembly jig, resting it on the support 24/1.
9. On the inside of the crankcase half, above the bore for the bearing, insert a metal strip 65/1 (180x25x0.3 mm).
10. Fit crankshaft 65/1.

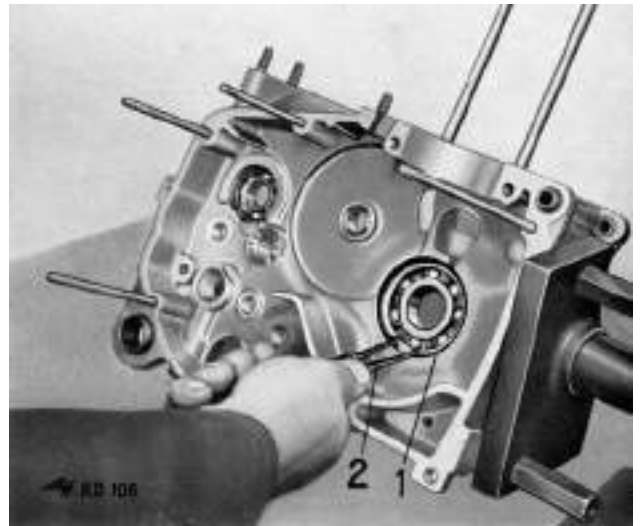

63 Fitting the Seeger rings

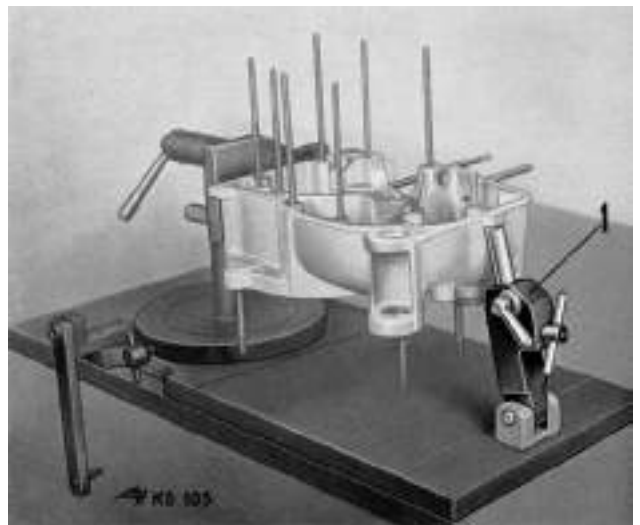

64 Assembly jig with crankcase half



65 Fitting the crankshaft

11. Take out the metal strip so that, whilst the left hand half of the casing is being screwed on, the crank assembly can adjust itself to the proper spacing.
12. Insert small timing sprocket wheel 66/2. The cylindrical pin must mesh with the guiding groove of the sprocket wheel without any play.
13. Fit large timing sprocket wheel 66/3 with camshaft.

Please note:

To ensure perfect sprocket wheel timing, the marked tooth of the small sprocket wheel 66/2 must mesh with the two marked teeth of the large timing sprocket wheel. (See figure 66/A.)

14. Put packing compound on the separating faces of the crankcase halves.
15. Fit left-hand housing half (Clutch side).
16. Screw together both crankcase housing halves, using hex. nut (SW 10) 60/6 and disc on the clutch side, two lock nuts (5 W 10) 67/4 with discs on the dynamo side.
17. For further assembly work, see page 25 "Assembling the Dynamo", paragraphs 1 to 10, 21 and 22; page 27 "Adjusting the ignition", paragraphs 1 to 8; page 21 "Fitting the clutch", paragraphs 1 to 26; page 12, "Reassembling the Cylinder Head, Cylinder and Piston", paragraphs 1 to 12.
Reverse procedure of "Dismantling the engine - reassembling the engine" page 9, paragraphs 1 to 13.

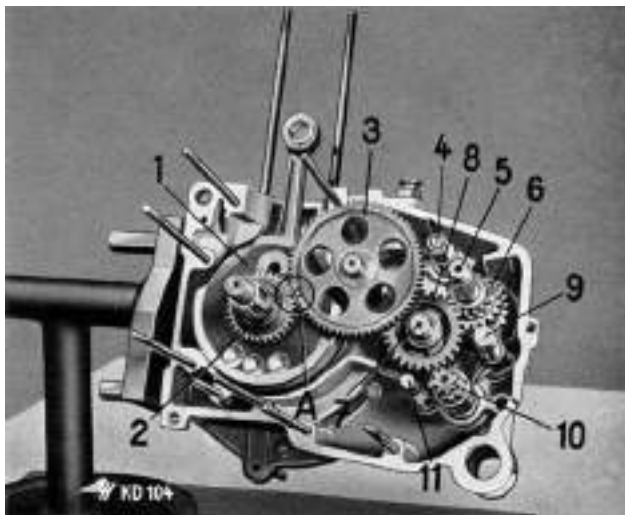

66 Adjusting the timing sprocket wheels

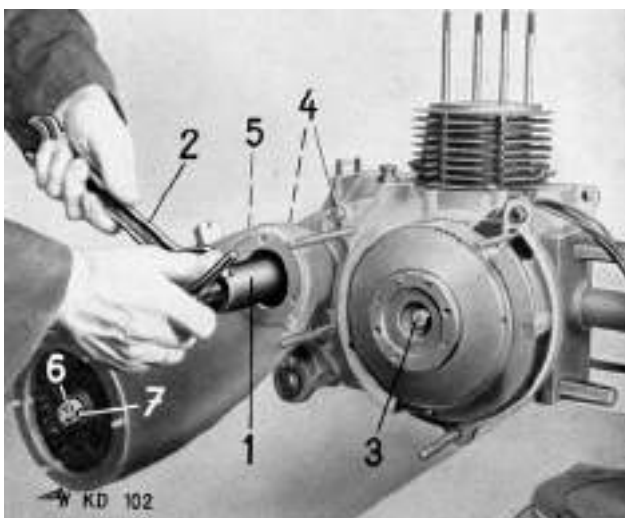

67 Right hand half of crankcase housing

Dismantling the Gears

Please note:

To carry out this repair work, proceed as explained on page 9, "Dismantling the engine- reassembling the engine", paragraphs 1 to 13; page 11 "Dismantling the Cylinder Head, Piston and Cylinder" paragraphs 1 to 5; page 19 "Dismantling the Clutch", paragraphs 1 to 10; page 34 "Dismantling crankshaft and bearing", paragraphs 1 and 2, to be followed by:

1. Lift the control fork spindle 68/11 (10 mm. Ø) out of its guide. Twist the gear shift fork to the left and withdraw it.
2. Lift the control fork spindle 68/9 (14 mm. Ø) out of its guide. Twist the gear control fork to the right and withdraw it.
3. Lift off the shift roller 68/10, looking out for the butting ring. (Only for shift roller with stop notches.)
4. Lift off transmission shaft 68/7 with its toothed wheels and also clutch shaft 68/5 with its toothed wheels 68/6.

Please note:

When removing driven shaft, also proceed as explained on page 23 "Dismantling the Dynamo", paragraphs 1 to 10, and on page 29 "Dismantling the Swinging Arm", paragraphs 4 to 9.

5. Remove the driven shaft 65/2 with ball bearing 6005 by tapping it slightly with a rubber or plastic hammer. (Remove in the direction of gears.)
6. Remove bearing from driven shaft.
7. If drag levers or drag arm cross shaft are to be exchanged, with a screw driver force the retaining disc off the cross shaft 68/4.
8. Remove the drag levers. An abutting disc is interposed between the two drag levers.
9. Before removing the drag arm cross shaft, remove the Seeger ring on the outside of the right-hand half of the crankcase.

Please note:

To remove drag arm cross shaft, heat crankcase half.

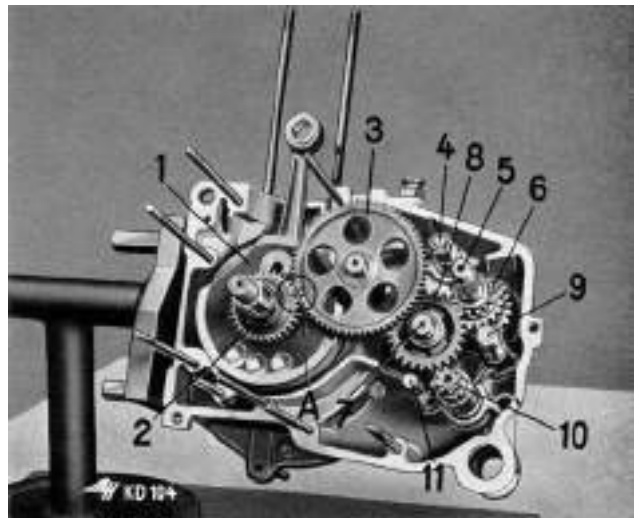

68 Removing the gears

Fitting The Gears

Please note:

To fit the driven shaft and the drag arm cross shaft, heat the crankcase half.

1. Insert driven shaft with bearing from the gears side.
2. Insert drag arm cross shaft and secure with Seeger ring.
3. Insert drag levers. Insert the interposed abutting disc. Secure drag levers with disc and circlip. (Afterwards test for easy movement.)

Clutch Spindle

4. Coat the needle bearing (two parts) with ballbearing grease and place on clutch spindle 69/1.
5. Push the sleeve ring 69/3 with snap ring 69/4 on to 2nd gear drive pinion, the strongly chamfered inner side of the sleeve ring points towards the toothed part of the 2nd gear drive pinion.
6. Push the 2nd gear drive pinion 69/5 over the needle bearing as far as to the shoulder of the clutch spindle.
7. Insert the segment key in the recess of the 2nd gear drive pinion.
8. Push sleeve ring 69/3 over the segment key and press snap ring 69/4 into place between sleeve ring and 2nd gear drive pinion.
9. Fit gear pinion for 2nd and 4th gear onto the clutch spindle in such a way that the figure 4 is pointing towards the driven shaft.
10. Insert clutch spindle 69/1 with gear pinions mounted on to driven shaft 69/7.

Transmission Shaft

11. Push pressure ring over short key shaft section of the lay shaft 69/8 as far as to the shoulder.
12. Fit the 3rd gear drive pinion 69/11 so that the 4 dogs point towards the large key shaft section 69/8 of the lay shaft 69/8.
13. Fit gear pinion for 1st and 3rd gear 69/10. Fit the 2nd gear pinion 69/12 (with spline shaft section). The collar points to the 3rd gear pinion 69/11.
14. Fit 1st gear drive pinion 69/9 to transmission shaft 69/8, the shoulder turned to gear pinion for 1st and 3rd gear.
15. Fit transmission shaft 69/8 (with gear pinions mounted) into the bearing bush.
16. Fit gear change control cylinder 69/13.
17. Fit ring washer 69/14 to gear change control cylinder.

Please note:

If the gear change control cylinder carries no notches (latest model!) no ring washer is required.

18. Insert the gear shift fork for 2nd and 4th gear with its gear shift spindle (14 mm. Ø) in the recess on the gear pinion for 2nd and 4th gear.
19. Twist the gear shift fork to the left, so that the guide bolt engages in the guide groove "A" on the gear change control cylinder (control roller).
20. Insert the gear shift spindle (14 mm. Ø!) in its mounting in the crankcase housing.
21. Fit the gear shift fork 69/16 (for 1st and 3rd gear) with its spindle (10 mm. Ø) in the recess on gear drive pinion for 1st and 3rd gear 69/2.
22. Twist the gear shift fork to the right, so that the guide bolt engages in the guide groove "B" on the gear change control cylinder (control roller).
23. Fit the gear shift spindle (10 mm. Ø) in its mounting in the crankcase housing.
24. Fit spacing bush 69/2 on to clutch spindle 69/1.
25. For further assembly work, proceed as explained on page 36 "Fitting crankshaft and bearing", paragraphs 13 to 16, and page 31 "Fitting the swinging arm", paragraphs 14 to 19, 22 to 24, and page 27 "Adjusting the ignition", paragraphs 1 to 8, and page 21 "Fitting the clutch", paragraphs 1 to 26, and page 12 "Reassembling the Cylinder Head, Cylinder and Piston", paragraphs 1 to 12.

Reverse procedure as per "Dismantling the engine; Reassembling the engine", page 9, paragraphs 1 to 13.

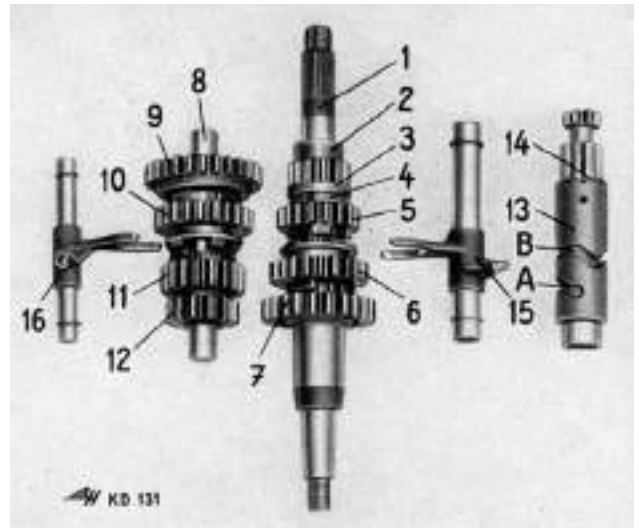

69 Gears

Disassembling and Fitting of Carburettor

1. Open lateral inspection lid, turn off fuel tap, undo air filter clamping screw and remove air filter.

Please note:

Do not drive scooter without air filter (otherwise abrasive dust-oil mixture will result in high cylinder and bearing wear).

2. Remove fuel lead, undo clamping screw on carburettor. Take off carburettor.
3. Remove carburettor housing cover. Remove gas piston, gas piston spring and pump jet needle from carburettor housing.
4. Disconnect Bowden cable on gas piston.
For reassembly, reverse procedure.

Disassembling and Fitting of BING Carburettor

1. Undo cover screw 70/B 1 and remove cover plate 70/B. Remove gas piston 70/C with gas piston spring 70/C 2 and pump jet needle 70/G from carburettor housing 70/A.
2. Unscrew float chamber cover 70/U 1 from float chamber.
3. Unscrew hollow screw (SW 12) and banjo connection 70/Y 1 (watch for fuel filter and gaskets).
4. Push float needle 70/X downwards, remove float 70/W.
5. Unscrew fixing screw 70/H 2 (SW 19), take off float chamber (watch for gasket).
6. Using a socket wrench, remove pump stop screw, at the same time unscrew the pump needle jet 70/F 2 (gasket!)

Please note:

To avoid damages to high precision-made accelerator pump when dismantling, remove needle jet complete i.e. with pump stop screw still in its position; fit complete jet as well.

Sequence:

Pump stop screw, main jet 70/H, spring and pump piston.

(When reassembling, take care that front face of pump piston 70/F 3 with its 4 holes is turned toward pump jet needle 70/G).

Disassemble pump piston.

Using a screw driver, take out pump valve screw.

Take care not to lose pump valve plate.

7. Undo screw (SW 9) 70/J 1 (gasket!). Unscrew idling jet.
8. Unscrew and remove air adjusting screw with spring 70/K 3.
9. Remove mixing chamber insert 70/E.
10. Using clean petrol, clean all components, then check for wear.

Please note:

The jets may not be reamed out or cleaned with a hard instrument. If necessary, replace very worn parts e.g. carburettor housing, pump needle jet, needle seat bush, gas piston, pump jet needle and float needle, as those parts, when worn, would adversely affect fuel consumption, performance and slow running adjustment.

11. Replace defective gaskets. For reassembly, reverse above procedure.

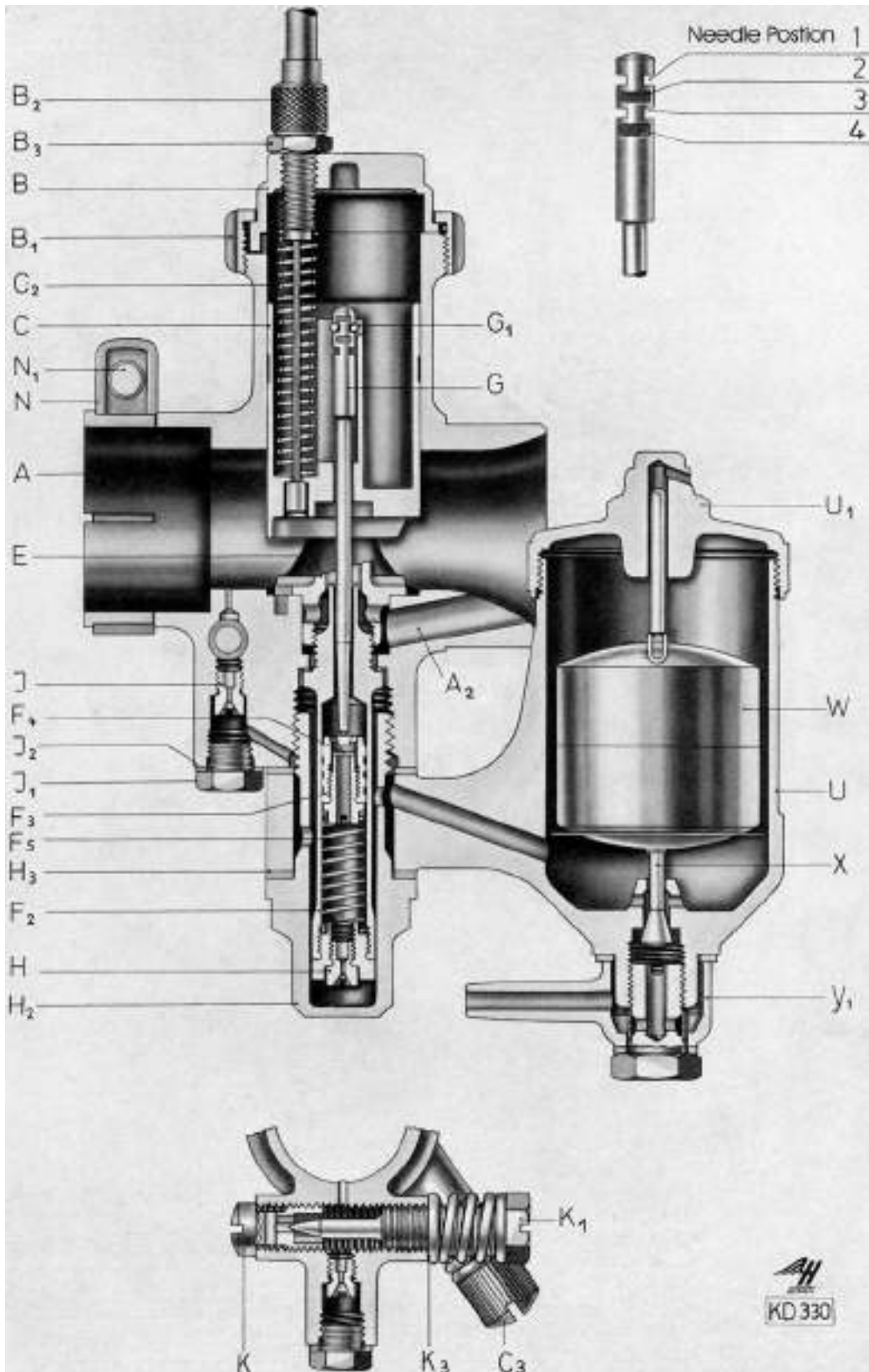

70

BING-Carburettor 1/20/46

A	Carburettor Housing	C 3	Adjusting screw	H	Main jet	N	Clamp ring
A 2	Evaporator air bore	E	Mixing chamber insert	H 2	Screw	N 1	Clamp screw
B	Cover plate	F 2	Pump needle jet	J	Idling jet	U	Float chamber
B 1	Cover Thread	F 3	Pump piston	J 1	Screw	U 1	Float chamber cover
B 2	Adjusting screw	F 4	Valve plate	J 2	Sealing disk	W	Float
B 3	Nut	F 5	Spring	K	Idling jet	X	Float needle
C	Gas piston	G	Pump jet needle	K 1	Air adjusting screw	Y 1	Banjo connection
C 2	Gas piston spring	G 1	Clamp bracket	K 3	Spring		

Disassembling and Fitting of Pallas Carburettor

1. Remove 2 countersunk screws 71/7 on cover plate. Take off gas piston 71/2, gas piston spring 71/3 and pump jet needle 71/8 from carburettor housing 71/1 (watch for gasket 71/44).
2. Remove 2 countersunk screws 71/26 on float chamber, remove cover 71/25 (gasket 71/43!).
3. Unscrew hollow screw 71/36 (SW 12) and remove banjo connection 71/33. (Watch for fuel filter 71/34 and gaskets 71/35 and 71/32).
4. Undo collar nut 71/31 (SW 17), push needle seating bush 71/29 with float needle 71/28 and float 71/27 toward the side of float chamber housing, (gaskets 71/30).
Remove float needle.
5. Remove pump locking screw 71/23 (SW 19). (Watch for gasket 71/24).
6. Using socket wrench (SW 10), undo pump stop screw 71/15, at the same time removing the pump needle jet 71/10.

Please note:

To avoid damage to high-precision made accelerator pump when dismantling, only remove complete needle jet, i.e. with pump lock screw still in its position; for reassembly fit complete needle jet as well.

Sequence:

Pump lock screw 71/15, main jet 71/16, spring 71/14 and pump piston.

(When assembling, take care that front face of pump piston 71/11 with its 4 holes is turned toward pump jet needle 71/10.)

Dismantle pump piston 71/11.

Using a screw driver, remove pump valve screw 71/13. Be careful not to lose valve plate.

7. Undo screw 71/18, remove idling jet 71/17.
8. Undo counter nut 71/20 (SW 9), remove air adjusting screw 71/19.
9. Using clean petrol, clean all parts. Then check for wear.

Please note:

The jets may not be reamed out or cleaned with a hard instrument. If necessary, replace very worn parts e.g. carburettor housing, pump needle jet, needle seat bush, gas piston, pump jet needle and float needle, as those parts, when worn, would adversely affect fuel consumption, performance and slow running adjustment.

10. Remove defective gaskets.
For reassembly, reverse above procedure.

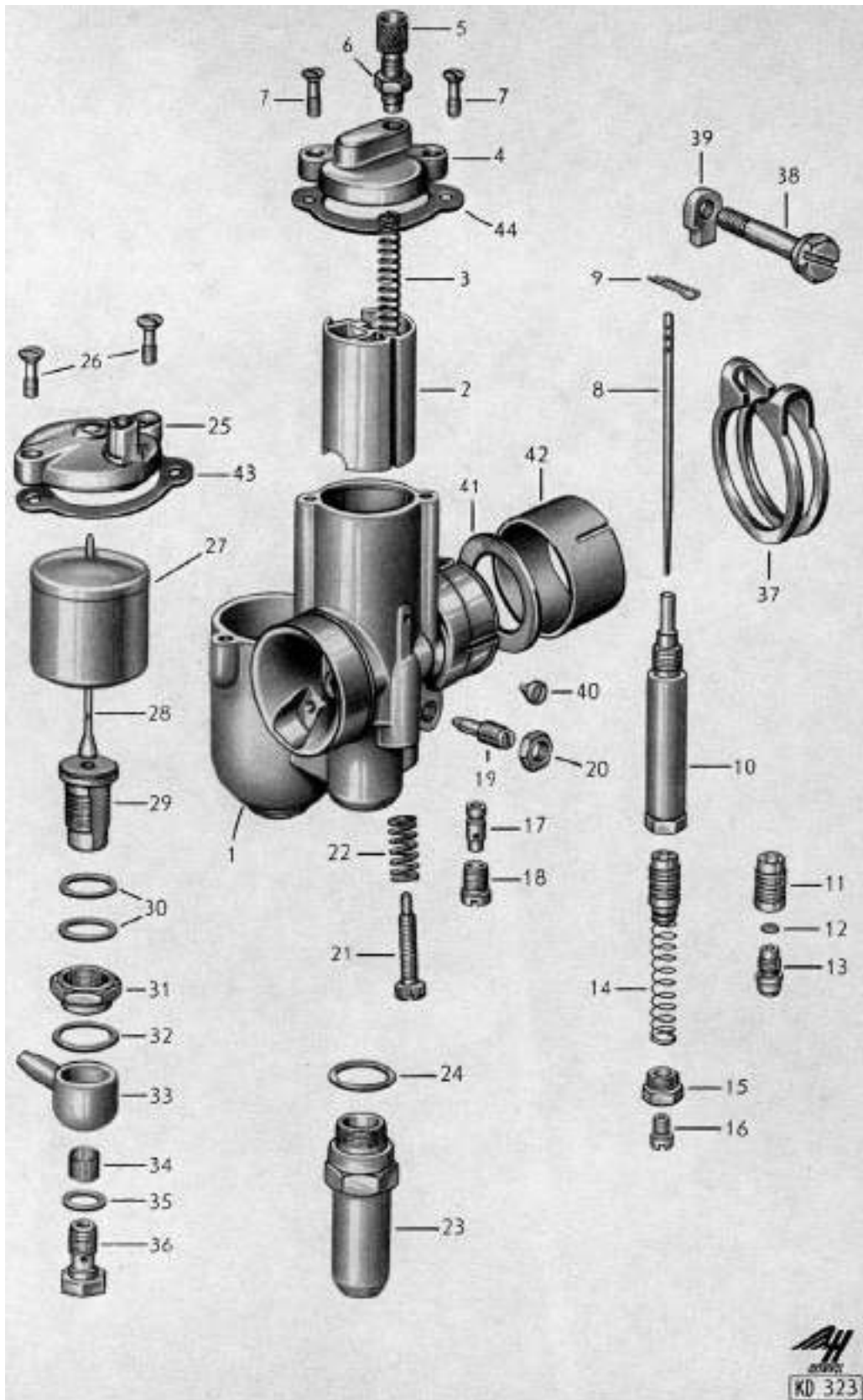

71

Pallas-Carburettor 20/14P

Chassis

Removing and Refitting the Front Fork

1. Remove headlamp with headlamp ring, disconnect cables.
2. Undo 6 countersunk screws and remove front wheel cowling.
3. Undo clamp screw for speedometer spiral and remove spiral.
4. Undo hex. nut (SW 10) on front brake control cable. Disconnect control cable from the brake lever, remove brake control cable.
5. Undo both front wheel axle nuts and remove the wheel.
6. Unscrew front wheel mudguard.
7. Undo hex. nut 72/1 (SW 14) on clamping-ring.
8. Remove handle bar, complete. (Put a clean rag between front guard and steering to avoid scratches on the enamel.)
9. Undo both safety screws on ring nut 72/2. Remove ring nut.
10. Remove rubber disc 72/3.
11. Pull front fork 72/4 downward and out.
Important: Watch but for any balls falling out. (There are 33 5 mm. Ø, balls at the top and another 33 at the bottom.)
12. Take off rubber ring 72/3.
13. Remove the balls.
14. For reassembly, reverse above procedure.

Please note:

When fitting the front fork, tighten ring nut only so that the fork has no play left, but remains easily movable.

When fitting the front wheel, the recess on the rear wheel hub must be engaged in the cam of the right-hand front wheel leg, as otherwise when the brake is sharply applied for the first time after assembly, the wheel will lock and the driver fall. Adjust the front wheel brake so that the wheel will run smoothly. The brake lever on the handlebar must show resistance when the first quarter of its overall movement has been travelled.



72 Chassis with front fork

Dismantling and Fitting of Front Fork

Please note:

When carrying out repair work on the front fork, proceed as explained on page 43 "Removing and Refitting the front fork", paragraphs 1 to 14, being followed by:

1. Remove shock-absorbers from front fork.
2. Unscrew and remove oil drain screw (SW 14) 73/4 and take off outer tube 73/3.
3. Take off bellows portion.
4. Unscrew and undo oil filler screw 73/1 (SW 17) and remove pressure springs 73/2.
5. Screw outer pressure springs 73/2 off spring holder; take out interior pressure spring.
6. For reassembly, reverse above procedure.

Please note:

When fitting the bellows portion, make sure that the smaller diameter is pulled over the outer tube.

The oil filling in the front fork amounts to 30 cc. per leg of good engine oil such as Mobiloil A (SAE 30).

When released, the outer pressure spring has an overall length of 328 ± 2 mm. At a pretension of 50 mm the spring must show a load of $P = 35.5$ kg.

When released, the inner pressure spring has an overall length of 302 ± 2 mm. At a pretension of 50 mm the Spring must show a load of $P = 12.0$ kg.

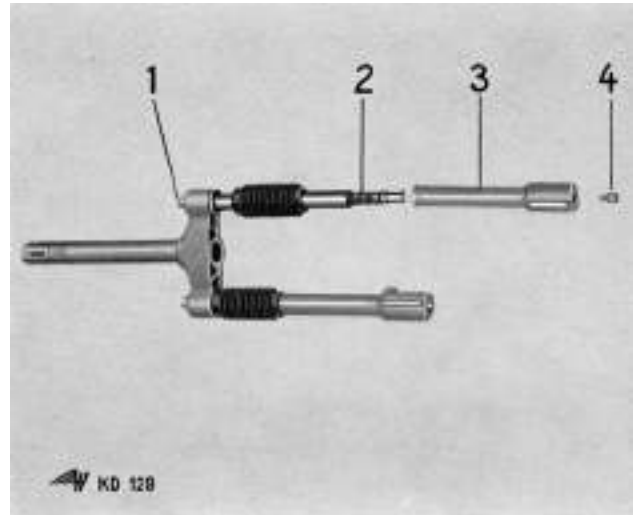

73 Front fork, xploded view

Removing and Fitting of Frame and Fork Ball Races

Please note:

If frame and fork ball races are to be changed, remove front fork, as explained on page 43, paragraphs 1 to 13.

1. Using a punch 74/2, remove frame races 74/1 by tapping from top and bottom respectively.

Please note:

Remove the races by tapping uniformly on the whole circumference of the races. By tapping on but one spot, the resulting tilting effect might deform the tube and, when refitting the races, they might no longer be a perfect fit.

2. Clean the frame tube. Press the frame races into the frame tube, perhaps also by using a wooden punch and a light hammer.
3. Remove fork race on front fork by using a special chisel and a light hammer. Apply chisel alternately to both grooves.
4. If necessary, remove burr from front piece (race support).
5. Using a tube, press fork race onto front fork, or use a light hammer.
6. Fit front fork as explained on page 43, paragraph 14.

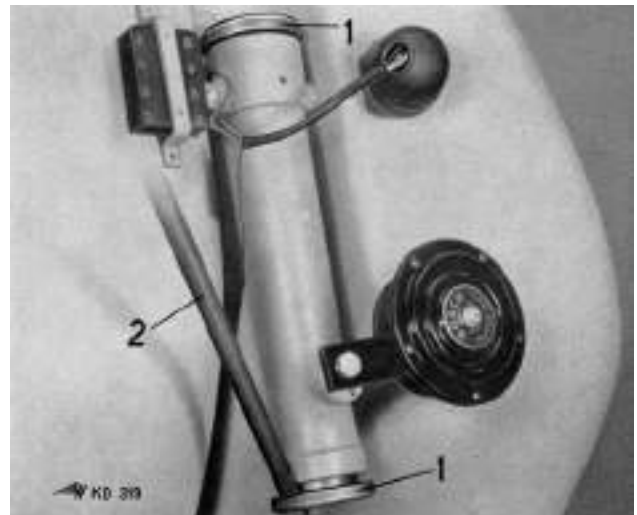

74 Removing frame race

Removing and Fitting of Front Wheel Hub

1. Using socket spanner (SW 17), undo wheel nuts.
2. Undo clamp screw for speedometer spiral, remove spiral.
3. Undo hex. nut on front wheel brake control cable. Disconnect cable on brake lever, take off control cable.
4. Take off both front wheel axle nuts, remove front wheel.
5. Remove rim with tyre from hub.
6. Take off the brake disc with brake shoes. (Watch out for spacing washer 75/2.)
7. Remove speedometer drive 75/5 and gasket 75/4.
8. Remove bush 75/7 and front wheel axle.
9. Push aside spacing sleeve and, using a punch and a light hammer, remove ball bearing 6202 toward "brake side". Take off spacing sleeve.
10. Remove inner Seeger ring, bearing 6202 and outer Seeger ring (in direction of "brake side").
11. Remove radial gasket (in speedometer direction).
12. For reassembly, reverse above procedure.

Please note:

When fitting speedometer drive 75/5 and gasket 75/4, the guide pins 75/5 a must be engaged in catch 75/3 a, and recess 75/5 b in catch 75/3 b.

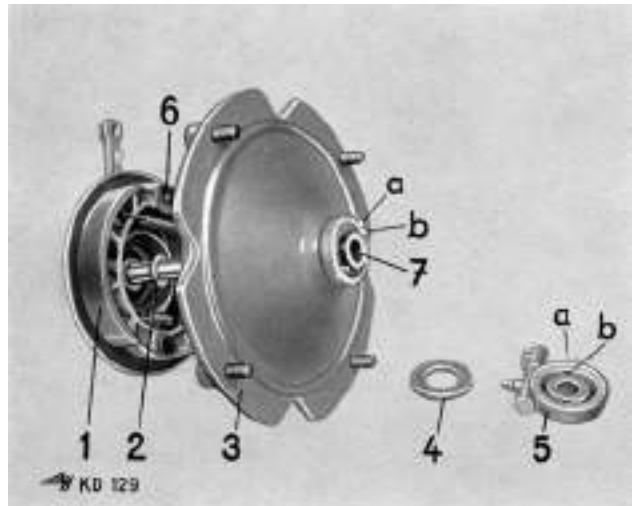

75 Front wheel hub

Removing and Fitting the Brake Shoes

Please note:

Brake shoes should always be changed in pairs. If the "old" shoes are used again, mark them before removal so that they can be replaced in the same position as before. Do not try to make worn-out brake linings good by rivetting on new linings, but use Exchange Brake Shoes.

Front Wheel

Please note:

When replacing the front wheel hub into the front fork, make sure that the recess in the brake disc engages with the dog on the right-hand fork leg as otherwise, when the brake is first applied sharply, the wheel will lock and the driver may fall.

To remove the brake shoes, proceed as explained on page 45 "Removing and Fitting of Front Wheel Hub", paragraphs 1 to 6.

1. Apply a pair of special pliers for brake shoes (401/W 8) 76/2 and (401/W 10) 76/1, lift off brake shoes 75/1.
2. For reassembly, reverse above procedure.
3. When changing the brake key 75/6, make sure that the long dog of the brake key (notch) is pointing downwards, as otherwise the performance of the brakes will be impaired.

When fitting, the brake lever on the brake disc must be displaced by 3 teeth, (measured with brake key at 90 degrees to driving direction). (This also applies to all new brake shoes.)

4. Adjust the front wheel brake so that the wheel still turns smoothly. The brake lever on the handle bar must offer some resistance after having travelled first quarter of its overall path.

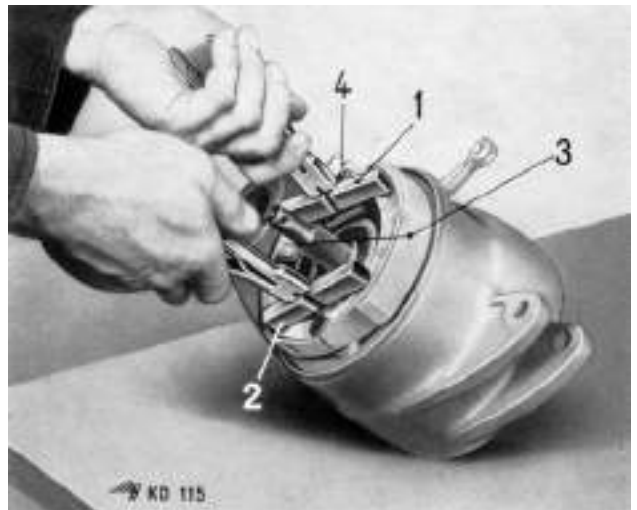

76 Removing and fitting brake shoes

Rear Wheel

1. Undo 4 wheel nuts and remove rear wheel.
2. Remove protective rubber cap and cotter pin.
3. Using socket spanner (SW 24), undo crown nut (with a counter-holder) and take off brake disc.
4. Apply pliers for brake shoes (401/W 8) 76/2 and (401/W 10) 76/1 and lift off brake shoes 76/3.
5. For fitting, reverse above procedure.
6. When changing the brake key 76/4, make sure that the long dog of the brake key 76/4 is pointing upwards, as otherwise the performance of the brakes will be impaired.
7. Adjust the rear wheel brake so that the rear wheel still runs smoothly. The foot brake lever on the foot plate must show resistance after having travelled one/fifth of its total movement.

Adjusting The Control Cables

Please note:

First proceed as explained on page 9, "Dismantling and re-assembling the engine", paragraph 1.

When exchanging the gear control cable bear in mind that:

When gears are engaged in third, the setting mark on the cable roller on gear cable handlebar twist grip must conform with the mark on the housing. The long cable leads from front side, of twist grip to the top pivot on the clutch cable. The short cable leads from rear of twist grip to the bottom pivot on clutch cover.

1. Place, twist grip on left hand handlebar side in position 0 (neutral; idling run).
2. Check sleeves on cable ends at setting screws for play.

Please note:

At the setting screws 77/2 the Control cables must be easily movable without any play.

3. Turn twist grip to 1st or 4th gear.
4. By progressively screwing in or out the setting screws 77/2 on clutch cover, adjust the control cables 77/1 so that when the rear wheel turns any gear switched into by twist grip will be engaged.
5. After the above adjusting, by turning twist grip check that all 4 gears engage precisely.
6. If necessary, adjust on the setting screws, subsequently tightening counter nut 77/3.
7. Check rubber hoses for damages and, if necessary, grease them (grease-gun 3/4).
8. For further work, reverse procedure as explained on page 9 "Dismantling and reassembling engine", paragraph 1.

Adjusting the clutch play

Please note:

First proceed as explained on page 9 "Dismantling the engine - reassembling the engine", paragraph 1.

1. Loosen counter nut 77/6 of setting screw 77/5.
2. Screw in or screw off respectively the setting screw 77/5 on the clutch cover until the clutch lever on the handlebar can be moved by about 20 mm (outer tip of lever), with the clutch being fully engaged.

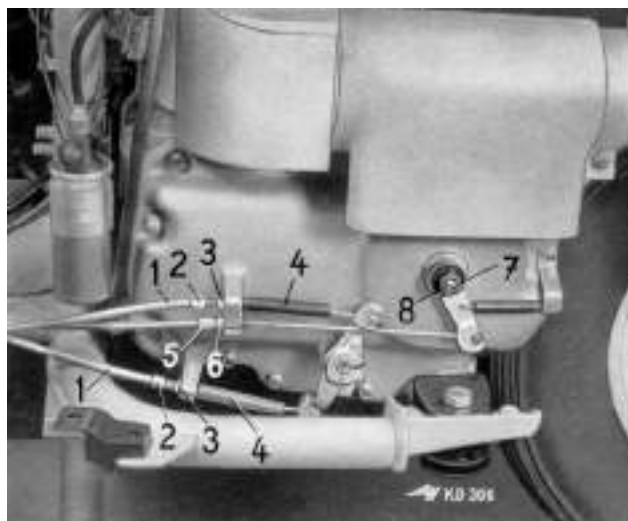

77 Adjusting controls and clutch

- Tighten counter nut on setting screw.

Please note:

When setting screw cannot be further adjusted, screw in setting screw 77/5 fully into clutch cover. Loosen hex. nut 77/7 on clutch lever. Turn clutch pin 77/8 to the left and again tighten hex. nut 77/7.

Carry out final adjusting on setting screw on clutch cover.

Adjusting the Headlamp

Please note:

The headlamp should be adjusted before a bright workshop wall, upon a level surface, the vehicle has to be under load at the following tyre pressures:

	Front wheel	Rear wheel	Sidecar wheel
Driver only	18 psi	26 psi	
Driver with pillion passenger	18 psi	29 psi	
Driver with sidecar passenger	22 psi	29 psi	22 psi
Driver with pillion and sidecar passengers	22 psi	36 psi	29 psi

- Place vehicle at 10 m distance from wall to middle of front-wheel.
- Mark a cross on the wall at 640 mm from foot of wall (=distance from floor to centre of headlamp).
- Switch on the "far" beam. If the headlamp is correctly adjusted, the beam centre must coincide with the middle of the cross.
- Switch on dip light. The separating line between lower brighter and upper darker beam sections should lie at 10 cm below the cross centre.
- If headlamp setting is to be adjusted, loosen the countersunk fillister-head screws on the support ring of the headlamp.
- Adjust headlamp and check again as explained in paragraphs 3 and 4. Tighten the countersunk screws again.

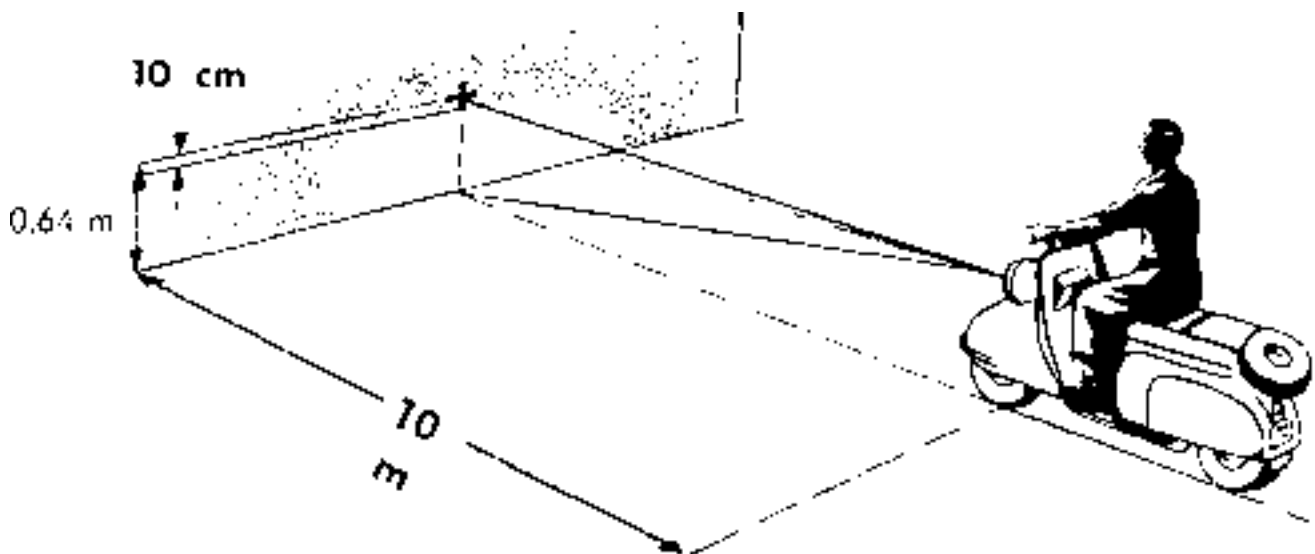

Removing and Fitting of Frame

Please note:

After carrying out the following operations, the frame can be removed. The following sequence is only suggested:

1. Remove the engine (see page 9, paragraphs 1 to 4 and 7 to 13).
2. Remove the battery-holder.
3. Take off the foot board with rubber journals.
4. Remove front fork (see page 43, paragraphs 1 to 5 and 7 to 13).
5. Remove the front shield with starting unit, fuse box and brake light switch.
6. Remove horn.
7. Remove engine suspension and ignition coil.
8. Take off foot brake lever with control cable.
9. Remove centre prop stand.
10. Withdraw steering lock.
11. Take out frame ball races (page 44, paragraph 1).
12. Check frame.
13. For reassembly, reverse above procedure.

Please note:

Crash-damaged frames can be checked at the HEINKEL factory by means of a special jig. Slightly bent frames (i.e. when the frame tube has not been flattened and thus correct stability is still ensured) can be straightened out. When fitting the control cables 79/1 and electric leads, these have to be placed on both sides of the frame as shown in figure 79, and secured with cable strings 72/2.

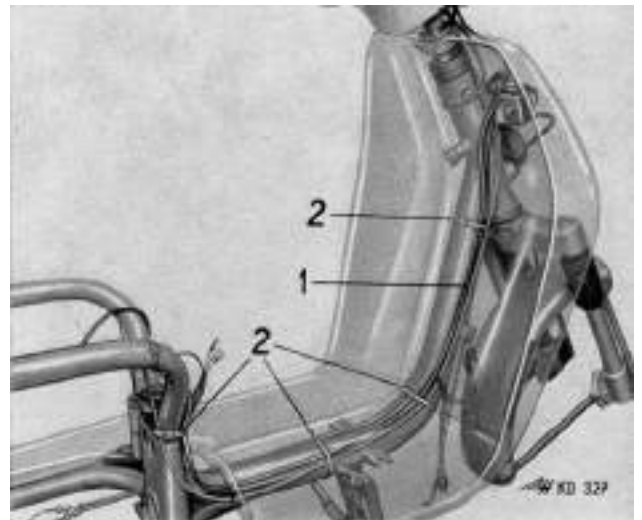

79 Leads and cables

HEINKEL – »TOURIST« 103 A-1

Performance diagram

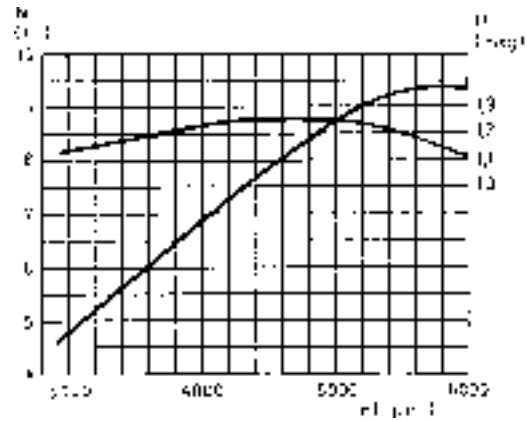

Speed diagram

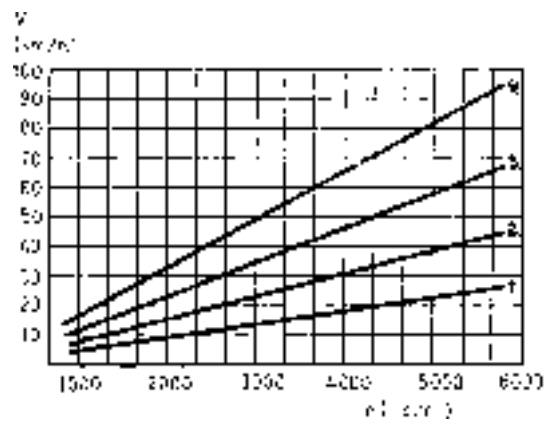

Climbing performance diagram

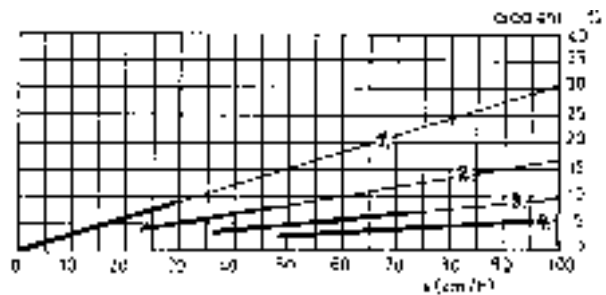

Fuel consumption diagram
(l/100 km = litres/100 km)

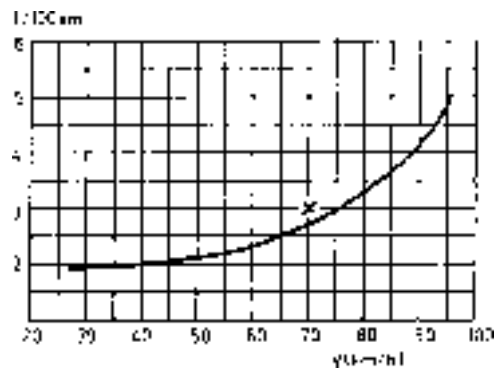

WIRING DIAGRAM FOR THE »HEINKEL-TOURIST« MOTOR SCOOTER, 175 c.c. Type 103 A-1

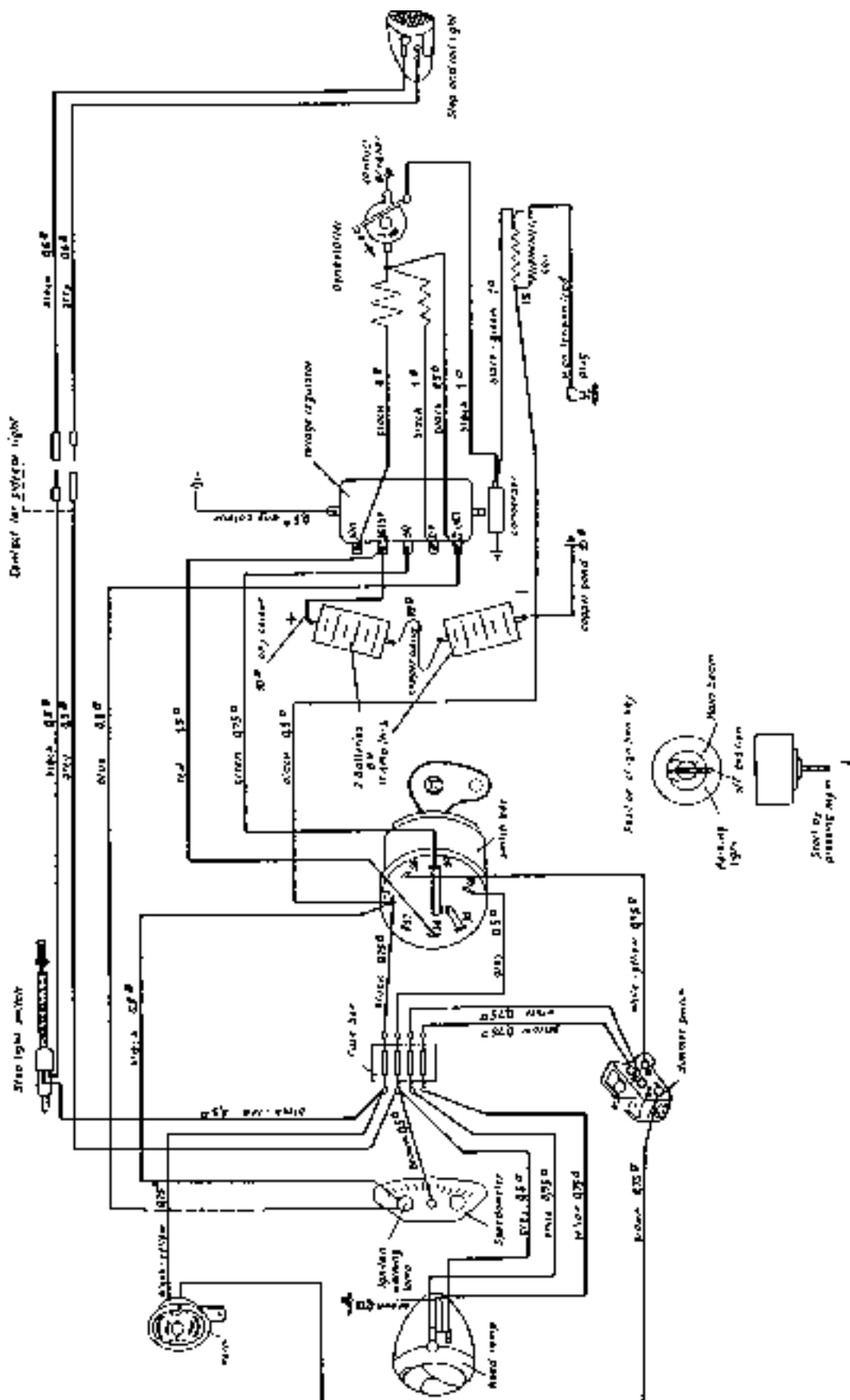

WARNING: When working on the electrical installation, first disconnect the batteries.

HEINKEL – »TOURIST« 103 A-1

Table of Loads

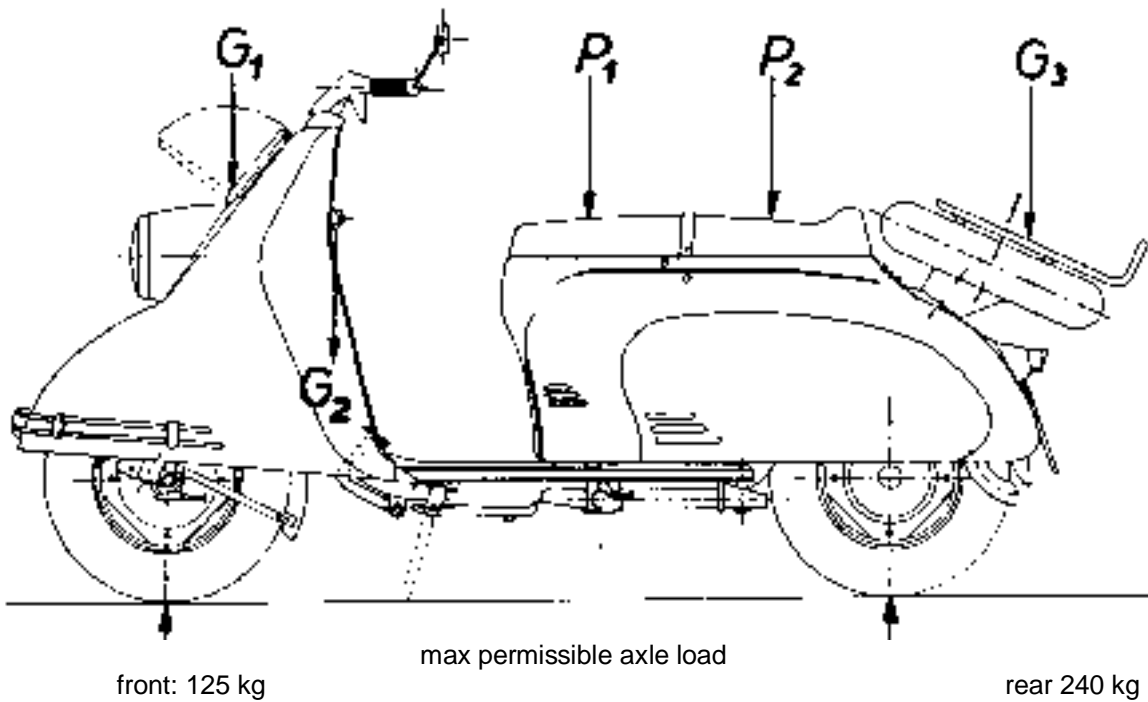

	Driver	Pillion Passenger	Luggage		
	P-1 kg	P-2 kg	Front carrier	Dash board hook	rear luggage
Distribution of Loads, max.	85	75	5	10	25
Medium Distribution of loads	75	70	5	10	20
Distribution of loads when no luggage is to be carried	110	90	–	–	–

weight of the scooter, ready to be driven	=	150 kg
luggage	=	40 kg
driver & pillion passenger	=	160 kg
Admissible total weight	=	<u>350 kg</u>

Weights, as heretofore indicated, are **not** to be exceeded.

Scooter Assembly Jig 103/W 10

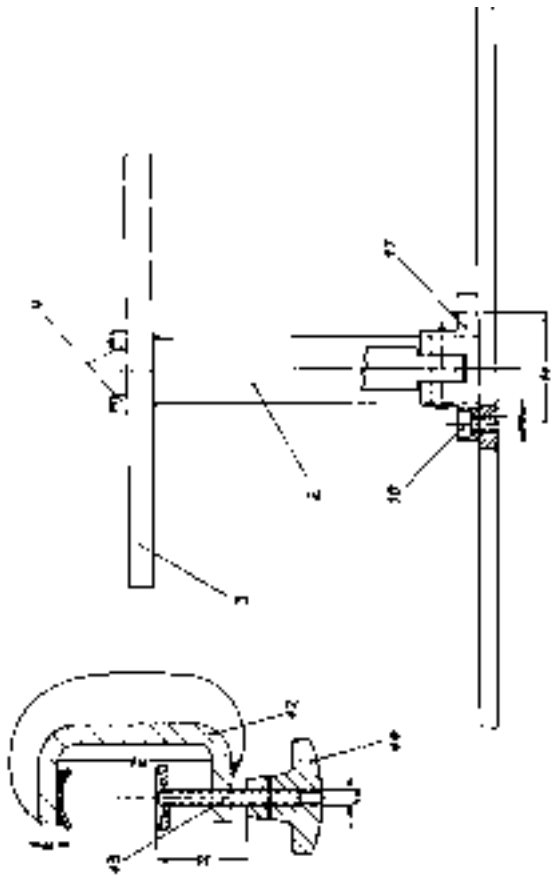

- 1 Base plate
- 2 Stand
- 3 Bushrod
- 4 Finishing screw
- 5 T-Handle
- 6 Lock
- 7 Bell
- 8 Spring
- 9 Hook bush
- 10 Full eye-lead spring
- 11 Support
- 12 Bracket
- 13 Spindle
- 14 T-Handle

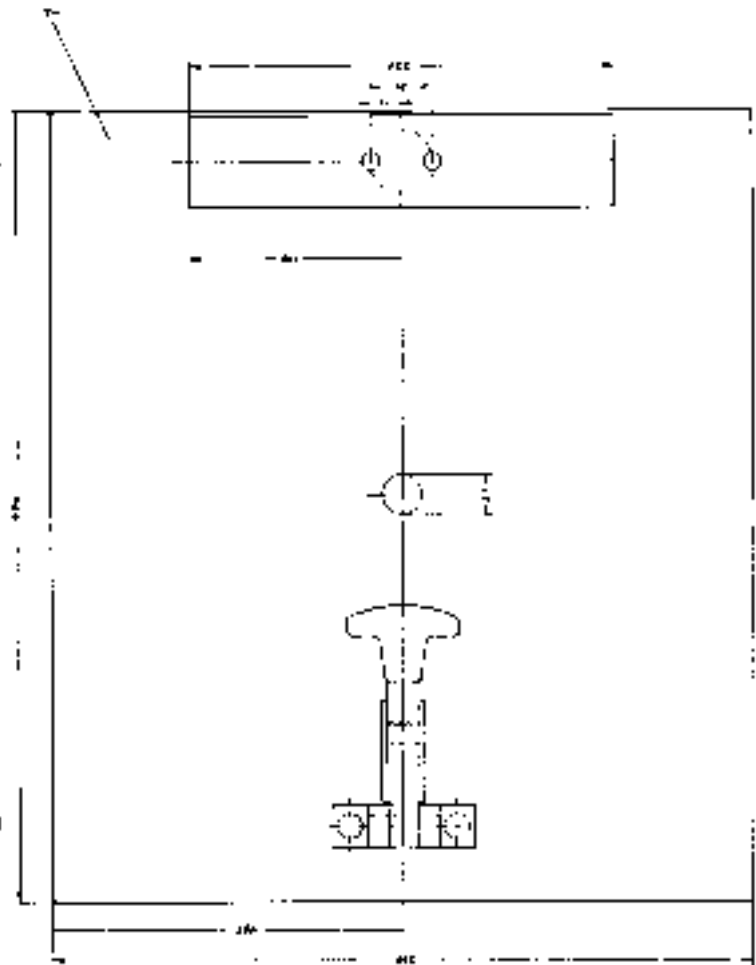
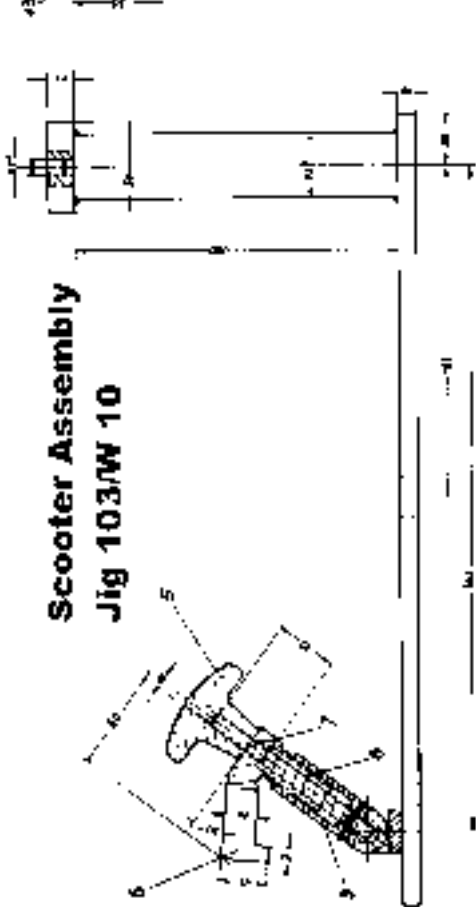

Engine Assembly Jig 401/W8

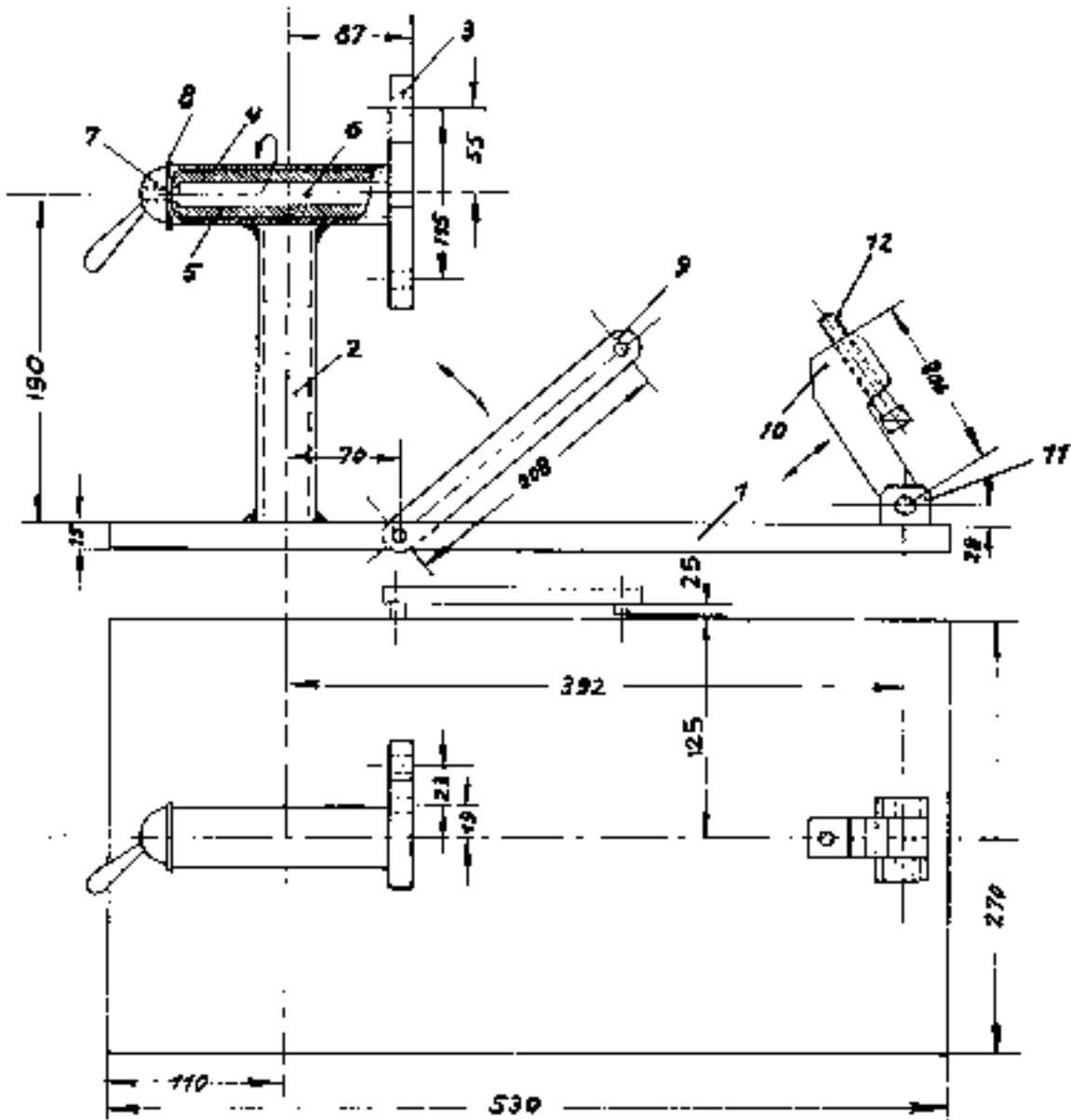

- 1 Base Plate
- 2 Tube
- 3 Front plate
- 4 Tube
- 5 Shank
- 6 Roll
- 7 Ball Handle M 12
- 8 Washer
- 9 Rear ring arm
- 10 Guide pipe
- 11 Block
- 12 Ball M 14
- 13 Special nut
- 14 Knurled screw

All dimensions given on the drawing are in millimeters
 Ø - Diameter

