



Ninja 250R

Motorcycle
Motocyclette
Motorrad

OWNER'S MANUAL

EX250K



* 9 9 9 7 6 - 1 4 1 7 *



KAWASAKI HEAVY INDUSTRIES, LTD.
Consumer Products & Machinery Company

Part No. 99976-1417

Printed in Thailand



ENGLISH

Motorcycle
Owner's Manual

Whenever you see the symbols shown below, heed their instructions! Always follow safe operating and maintenance practices.

 **WARNING**

This warning symbol identifies special instructions or procedures which, if not correctly followed, could result in personal injury, or loss of life.

CAUTION

This caution symbol identifies special instructions or procedures which, if not strictly observed, could result in damage to or destruction of equipment.

NOTE

O This note symbol indicates points of particular interest for more efficient and convenient operation.

NOTICE

THIS PRODUCT HAS BEEN MANUFACTURED FOR USE IN A REASONABLE AND PRUDENT MANNER BY A QUALIFIED OPERATOR AND AS A VEHICLE ONLY.

(Australian model only)

**TAMPERING WITH NOISE CONTROL SYSTEM
PROHIBITED**

Owners are warned that the law may prohibit:

- (a) The removal or rendering inoperative by any person other than for purposes of maintenance, repair or replacement, of any device or element of design incorporated into any new vehicle for the purpose of noise control prior to its sale or delivery to the ultimate purchaser or while it is in use; and
- (b) the use of the vehicle after such device or element of design has been removed or rendered inoperative by any person.

FOREWORD

Congratulations on your purchase of a new Kawasaki motorcycle. Your new motorcycle is the product of Kawasaki's advanced engineering, exhaustive testing, and continuous striving for superior reliability, safety and performance.

Please read this Owner's Manual carefully before riding so that you will be thoroughly familiar with the proper operation of your motorcycle's controls, its features, capabilities, and limitations. This manual offers many safe riding tips, but its purpose is not to provide instruction in all the techniques and skills required to ride a motorcycle safely. Kawasaki strongly recommends that all operators of this vehicle enroll in a motorcycle rider training program to attain awareness of the mental and physical requirements necessary for safe motorcycle operation.

To ensure a long, trouble-free life for your motorcycle, give it the proper care and maintenance described in this manual. For those who would like more detailed information on their Kawasaki Motorcycle, a Service Manual is available for purchase from any authorized Kawasaki motorcycle dealer. The Service Manual contains detailed disassembly and maintenance information. Those who plan to do their own work should, of course, be competent mechanics and possess the special tools described in the Service Manual.

Keep this Owner's Manual aboard your motorcycle at all times so that you can refer to it whenever you need information.

This manual should be considered a permanent part of the motorcycle and should remain with the motorcycle when it is sold.

All rights reserved. No part of this publication may be reproduced without our prior written permission.

This publication includes the latest information available at the time of printing. However, there may be minor differences between the actual product and illustrations and text in this manual.

All products are subject to change without prior notice or obligation.

**KAWASAKI HEAVY INDUSTRIES, LTD.
Consumer Products & Machinery Company**

©2008 Kawasaki Heavy Industries, Ltd.

Jan. 2008. (1). (CR, CR, Ke)

TABLE OF CONTENTS

SPECIFICATIONS	10	Stand.....	31	Additional Considerations for High Speed Operation.....	57	Drive Chain.....	94
LOCATION OF PARTS	14	Seats.....	32	MAINTENANCE AND ADJUSTMENT	59	Brakes.....	102
LOADING INFORMATION	17	Helmet Hooks.....	35	Periodic Maintenance Chart.....	60	Brake Light Switches.....	107
GENERAL INFORMATION	20	Tool Kit.....	36	Engine Oil.....	69	Front Fork.....	109
Meter Instruments.....	20	Tying Hooks.....	37	Cooling System.....	75	Rear Shock Absorbers.....	110
Speedometer and Tachometer. . .	21	BREAK-IN	38	Spark Plugs.....	81	Wheels.....	111
Coolant Temperature Gauge. . . .	21	HOW TO RIDE THE MOTORCYCLE	40	Kawasaki Clean Air System.....	82	Battery.....	117
Warning/Indicator Lights.....	21	Starting the Engine.....	40	Valve Clearance.....	83	Headlight Beam.....	123
Key.....	23	Jump Starting.....	42	Air Cleaner.....	83	Fuses.....	125
Ignition Switch/Steering Lock. . . .	23	Moving Off.....	44	Throttle Control System.....	87	Cleaning Your Motorcycle.....	126
Right Handlebar Switches.....	25	Shifting Gears.....	45	Engine Vacuum Synchronization. . .	90	STORAGE	132
Engine Stop Switch:.....	25	Braking.....	46	Idle Speed.....	91	ENVIRONMENTAL PROTECTION . . .	135
Starter Button:.....	26	Stopping the Engine.....	48	Clutch.....	92	LOCATION OF LABELS	136
Left Handlebar Switches.....	26	Stopping the Motorcycle in an Emergency.....	48			LABEL INFORMATION	138
Dimmer Switch:.....	26	Parking.....	49				
Turn Signal Switch:.....	27	Catalytic Converter.....	51				
Horn Button:.....	27	SAFE OPERATION	53				
Fuel Tank Cap.....	28	Safe Riding Technique.....	53				
Fuel Tank.....	29	Daily Safety Checks.....	55				
Fuel Requirement:.....	30						

SPECIFICATIONS**PERFORMANCE**

Maximum Horsepower	24 kW (33 PS) @11 000 r/min (rpm)
Maximum Torque	22.0 N-m (2.2 kgf-m, 16.2 ft-lb) @8 200 r/min (rpm)
Minimum Turning Radius	2.7 m (106.3 in.)

DIMENSIONS

Overall Length	2 085 mm (82.09 in.)
Overall Width	715 mm (28.15 in.)
Overall Height	1 115 mm (43.90 in.)
Wheelbase	1 400 mm (55.12 in.)
Road Clearance	130 mm (5.19 in.)
Dry Weight	152 kg (335 lb)
Curb Mass	169 kg (373 lb)

ENGINE

Type	DOHC, 2-cylinder, 4-stroke, liquid-cooled
Displacement	249 cm ³ (15.2 cu in.)

Bore x Stroke	62.0 x 41.2 mm (2.44 * 1.62 in.)
Compression Ratio	11.6:1
Starting System	Electric starter
Cylinder Numbering Method	Left to right, 1-2
Firing Order	1-2
Carburetion System	FI (Fuel Injection)
Ignition System	Battery and coil (transistorized ignition)
Ignition Timing	10° BTDC @1 300 r/min (rpm) ~ 38° BTDC @6 000 r/min (rpm)
(Electronically advanced)	
Spark Plugs	NGK CR8E
Lubrication System	Forced lubrication (wet sump)
Engine Oil	Type : API SE, SF or SG API SH, SJ or SL with JASO MA SAE 10W-40
	Capacity: 1.7 L (1.8 US qt)
Coolant Capacity	1.5 L (1.6 US qt)

TRANSMISSION

Transmission Type	6-speed, return shift	
Clutch Type	Wet, multi disc	
Driving System	Chain drive	
Primary Reduction Ratio	3.087 (71/23)	
Final Reduction Ratio	3.071 (43/14)	
Overall Drive Ratio	8.466 (Top gear)	
Gear Ratio	1st	2.600 (39/15)
	2nd	1.789(34/19)
	3rd	1.409(31/22)
	4th	1.160(29/25)
	5th	1.000(27/27)
	6th	0.893 (25/28)

FRAME

Castor	26°	
Trail	82 mm (3.2 in.)	
Tire Size:	Front	110/70-17M/C(54S)

Rear 130/70-17M/C(62S)

Rim Size: Front 17 x 2.75

Rear 17 x 3.50

Fuel Tank Capacity 17.8 L (4.7 US gal)

ELECTRICAL EQUIPMENT

Battery	12 V 8 Ah
Headlight	High beam 12 V 55 Wx 2 Low beam 12 V 55 W
Tail/Brake Light	12 V 5/21 W

CAUTION

The tail light uses a vibration resistant bulb. Replacement of the tail light bulb with a non-vibration resistant bulb may result in premature bulb failure. Use only the recommended bulb (Kawasaki part number 92069-0032) or equivalent.

Specifications subject to change without notice, and may not apply to every country.

LOCATION OF PARTS

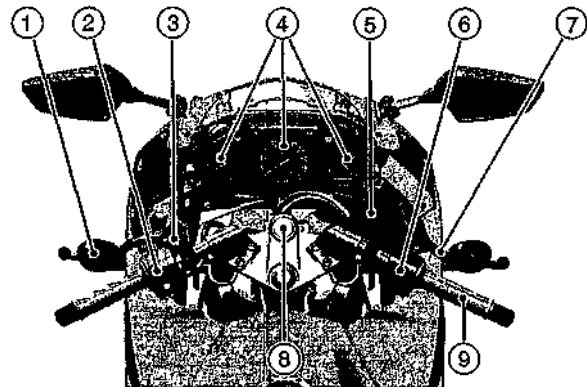

TD01140B G

- 1. Clutch Lever
- 2. Left Handlebar Switches
- 3. Starter Lockout Switch
- 4. Meter Instruments
- 5. Brake Fluid Reservoir (Front)

- 6. Right Handlebar Switches
- 7. Front Brake Lever
- 8. Ignition Switch/Steering Lock
- 9. Throttle Grip

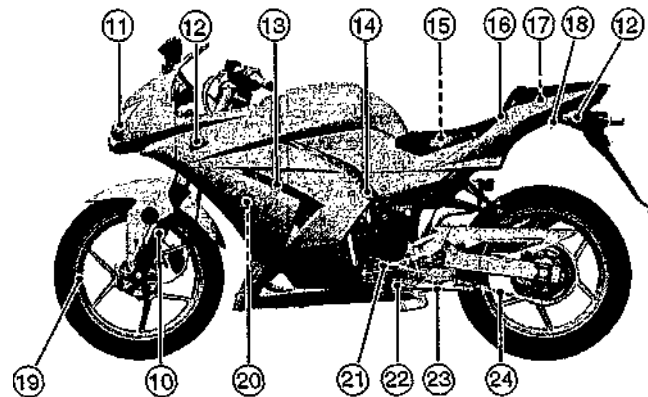

TD011418 G

- 10. Front Fork
- 11. Headlight
- 12. Turn Signal Light
- 13. Spark Plugs
- 14. Idle Adjusting Screw

- 15. Battery
- 16. Seat Lock
- 17. Tool Kit
- 18. Tying Hooks
- 19. Wheel

- 20. Radiator
- 21. Shift Pedal
- 22. Side Stand Switch
- 23. Side Stand
- 24. Drive Chain

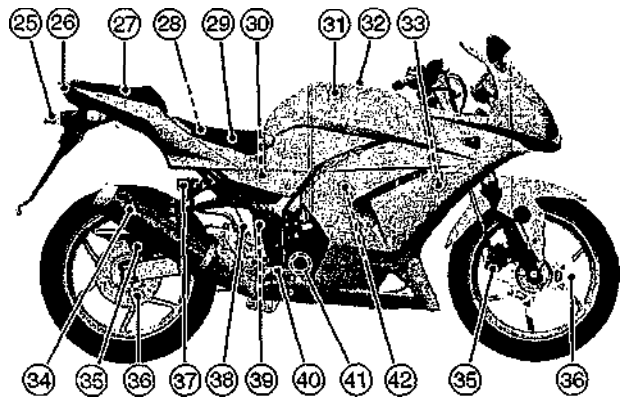

TD01142B G

- 25. License Plate Light
- 26. Tail/Brake Light
- 27. Passenger's Seat
- 28. Fuse Box**
- 29. Rider's Seat
- 30. Air Cleaner**

- 31. Fuel Tank**
- 32. Fuel Tank Cap
- 33. Radiator Cap
- 34. Muffler
- 35. Brake Caliper

- 36. Brake Disc**
- 37. Brake Fluid Reservoir (Rear)
- 38. Rear Brake Light Switch
- 39. Rear Shock Absorber
- 40. Rear Brake Pedal
- 41. Oil Level Gauge
- 42. Coolant Reserve Tank**

LOADING INFORMATION

WARNING

Incorrect loading, improper installation or use of accessories, or modification of your motorcycle may result in an unsafe riding condition. Before you ride the motorcycle, make sure that the motorcycle is not overloaded and that you have followed these instructions.

With the exception of genuine Kawasaki Parts and Accessories, Kawasaki has no control over the design or application of accessories. In some cases, improper installation or use of accessories, or motorcycle modification, will void the motorcycle

warranty, can negatively affect performance, and can even be illegal. In selecting and using accessories, and in loading the motorcycle, you are personally responsible for your own safety and the safety of other persons involved.

NOTE

O Kawasaki Parts and Accessories have been specially designed for use on Kawasaki motorcycles. We strongly recommend that all parts and accessories you add to your motorcycle be genuine Kawasaki components.

Because a motorcycle is sensitive to changes in weight and aerodynamic forces, you must take extreme care

in carrying cargo, passengers and/or in the fitting of additional accessories. The following general guidelines have been prepared to assist you in making your determinations.

1. Any passenger should be thoroughly familiar with motorcycle operation. The passenger can affect control of the motorcycle by improper positioning during cornering and sudden movements. It is important that the passenger sit still while the motorcycle is in motion and not interfere with the operation of the motorcycle. Do not carry animals on your motorcycle.
2. You should instruct any passenger before riding to keep his feet on the passenger footpegs and hold on to the operator, seat strap or grab rail. Do not carry a passenger unless he or she is tall enough to reach the footpegs and footpegs are provided.
3. All baggage should be carried as low as possible to reduce the effect on the motorcycle center of gravity. Baggage weight should also be distributed equally on both sides of the motorcycle. Avoid carrying baggage that extends beyond the rear of the motorcycle.
4. Baggage should be securely attached. Make sure that the baggage will not move around while you are riding. Recheck baggage security as often as possible (not while the motorcycle is in motion) and adjust as necessary.
5. Do not carry heavy or bulky items on a luggage rack. They are designed for light items, and overloading can affect handling due to changes in weight distribution and aerodynamic forces.

6. Do not install accessories or carry baggage that impairs the performance of the motorcycle. Make sure that you have not adversely affected any lighting components, road clearance, banking capability (i.e., lean angle), control operation, wheel travel, front fork movement, or any other aspect of the motorcycle's operation.
7. Weight attached to the handlebar or front fork will increase the mass of the steering assembly and can result in an unsafe riding condition.
8. Fairings, windshields, backrests, and other large items have the capability of adversely affecting stability and handling of the motorcycle, not only because of their weight, but also due to the aerodynamic forces acting on these surfaces while the motorcycle is in operation. Poorly

- designed or installed items can result in an unsafe riding condition.
9. This motorcycle was not intended to be equipped with a sidecar or to be used to tow any trailer or other vehicle. Kawasaki does not manufacture sidecars or trailers for motorcycles and cannot predict the effects of such accessories on handling or stability, but can only warn that the effects can be adverse and that Kawasaki cannot assume responsibility for the results of such unintended use of the motorcycle. Furthermore, any adverse effects on motorcycle components caused by the use of such accessories will not be remedied under warranty.

Maximum Load

Weight of rider, passenger, baggage, and accessories must not exceed 170 kg (375 lb).

Meter Instruments

- A. Tachometer
- B. Oil Pressure Warning Light
- C. Neutral Indicator Light
- D. Speedometer
- E. Odometer
- F. Turn Signal Indicator Light
- G. High Beam Indicator Light
- H. Coolant Temperature Gauge
- I. Red Zone
- J. Reset Button
- K. Trip Meter
- L. FI Indicator Light
- M. Fuel Level Warning Light

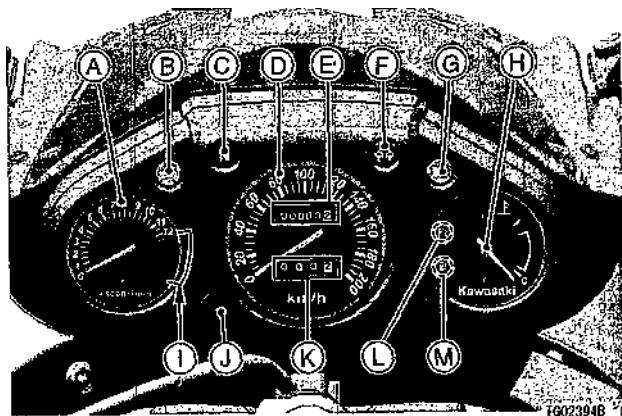

Speedometer and Tachometer

The speedometer shows the speed of the vehicle. In the speedometer face are the odometer and trip meter. The odometer shows the total distance that the vehicle has been ridden. The trip meter shows the distance traveled since it was last reset to zero. The trip meter can be reset to zero by pushing the reset button.

The tachometer shows the engine speed in the revolutions per minute (r/min, rpm). On the right side of the tachometer face is a portion called the "red zone." Engine r/min (rpm) in the red zone is above maximum recommended engine speed and is also above the range for good performance.

CAUTION

Engine r/min (rpm) should not be allowed to enter the red zone; operation in the red zone will overstress the engine and may cause serious engine damage.

Coolant Temperature Gauge

This gauge shows the temperature of coolant. Ordinarily, the needle should stay within the scaled zone. If the needle reaches the red zone (marked "H"), stop the engine and check the coolant level in the reserve tank after the engine cools down.

Warning/Indicator Lights

er.: The oil pressure warning light goes on whenever the oil pressure is dangerously low or the ignition key is in the ON position with the engine not running, and goes off when the engine

oil pressure is high enough. Refer to the Maintenance and Adjustment chapter for more detailed engine oil information.

 : When the headlight is on high beam, the high beam indicator light is lit.

 : When the turn signal switch is turned to left or right, the turn signal indicator light flashes on and off.

N : When the transmission is in neutral, the neutral indicator light is lit.

FI: The fuel injection (FI) warning light goes on when the ignition key is turned to "ON" and goes off soon after ensuring that its circuit functions properly.

The warning light also goes on whenever the troubles occur in digital fuel injection system (DFI). If the warning light comes on, have the DFI system checked by an authorized Kawasaki dealer.

 : The fuel level indicator light goes on when the ignition key is turned to "ON" and goes off soon after ensuring that its circuit functions properly. The warning light also goes on when 4.0 L (0.9 US gal) of fuel remains. Refuel at the earliest opportunity when the fuel level indicator light is still on with the engine running.

Key

This motorcycle has a combination key, which is used for the ignition switch/steering lock, seat lock, and fuel tank cap.

Blank keys are available at your Kawasaki dealers. Ask your dealer to make any additional spare keys you may need, using your original key as a master.

Ignition Switch/Steering Lock

This is a three-position, key-operated switch. The key can be removed from the switch when it is in the OFF or LOCK position.

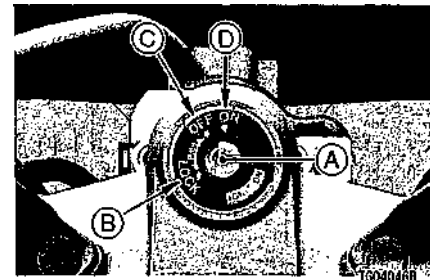

- A. Ignition Switch/Steering Lock
- B. LOCK position
- C. OFF position
- D. ON position

OFF	Engine off. All electrical circuits off.
ON	Engine on. All electrical equipment can be used.
LOCK	Steering locked. Engine off. All electrical circuits off.

NOTE

O The tail and license plate lights are on whenever the ignition key is in the ON position. One headlight goes on when the starter button is released after starting the engine. To avoid battery discharge, always start the engine immediately after turning the ignition key to "ON".

To lock the steering:

1. Turn the handlebar fully to the left.

2. For locking, push down the key in the OFF position and turn it to LOCK position.
3. Pull the key out.

NOTE

O If the steering is hard to lock, turn the handlebar slightly to the left or the right.

**Right Handlebar Switches
Engine Stop Switch:**

In addition to the ignition switch, the engine stop switch must be in the O position for the motorcycle to operate.

The engine stop switch is for emergency use. If some emergency requires stopping the engine, move the engine stop switch to the K position.

NOTE

O Although the engine stop switch stops the engine, it does not turn off all the electrical circuits. Ordinarily, the ignition switch should be used to stop the engine.

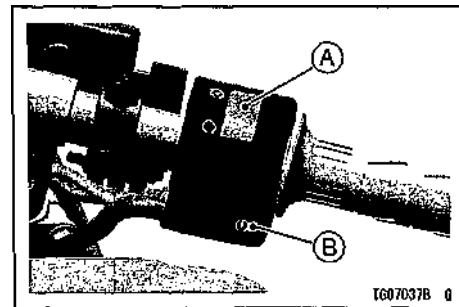

A. Engine Stop Switch
B. Starter Button

Starter Button:

The starter button operates the electric starter when the transmission is in neutral.

Refer to the Starting the Engine section of the "How to Ride the Motorcycle" chapter for starting instructions.

Left Handlebar Switches**Dimmer Switch:**

High or low beam can be selected with the dimmer switch. When the headlight is on high beam (), the high beam indicator light is lit.

High beam..... ()

Low beam..... ()

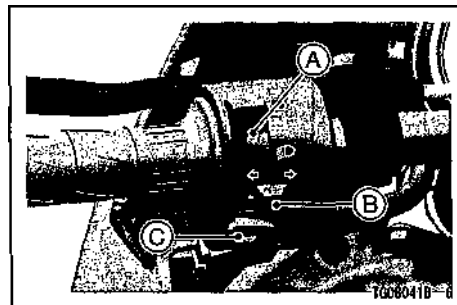

NOTE

O When the headlight is on high beam, both head lights are lit. When the headlight is on low beam, only one headlight is lit.



- A. Dimmer Switch
- B. Turn Signal Switch
- C. Horn Button

Turn Signal Switch:

When the turn signal switch is turned to the left () or right (), the corresponding turn signal flashes on and off.

To stop flashing, push the switch in.

Horn Button:

When the horn button is pushed, the horn sounds.

Fuel Tank Cap

To open the fuel tank cap, pull up the key hole cover. Insert the ignition key into the fuel tank cap and turn the key to the right.

To close the cap, push it down into place with the key inserted. The key can be removed by turning it to the left to the original position.

NOTE

○ *The fuel tank cap cannot be closed without the key inserted, and the key cannot be removed unless the cap is locked properly.*

NOTE

○ *Do not push on the key to close the cap, or the cap cannot be locked.*

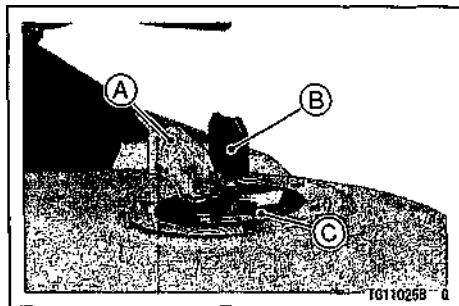

- A. Key Hole Cover
- B. Ignition Key
- C. Fuel Tank Cap

Fuel Tank

Avoid filling the tank in the rain or where heavy dust is blowing so that the fuel does not get contaminated.

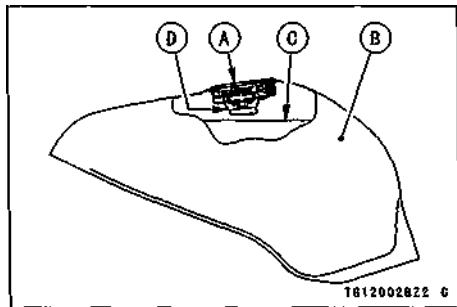

- A. Tank Cap
- B. Fuel Tank
- C. Top Level
- D. Filler Neck

WARNING

Gasoline is extremely flammable and can be explosive under certain conditions. Turn the ignition key to "OFF". Do not smoke. Make sure the area is well ventilated and free from any source of flame or sparks; this includes any appliance with a pilot light. Never fill the tank so the fuel level rises into the filler neck. If the tank is overfilled, heat may cause the fuel to expand and overflow through the vents in the tank cap.

After refueling, make sure the fuel tank cap is closed securely. If gasoline is spilled on the fuel tank, wipe it off immediately.

Fuel Requirement:

Your Kawasaki engine is designed to use only unleaded gasoline.

CAUTION

Do not use leaded gasoline, as this will destroy the catalytic converter. (For further information, refer to the "Catalytic Converter" section in the "How to Ride the Motorcycle" chapter.)

Octane Rating

The octane rating of a gasoline is a measure of its resistance to detonation or "knocking." The term commonly used to describe a gasoline's octane rating is the Research Octane Number

(RON). Always use a gasoline with an octane rating equal to, or higher than, RON 91.

NOTE

O If "knocking" or "pinging" occurs, use a different brand of gasoline or higher octane rating.

Stand

The motorcycle is equipped with a side stand.

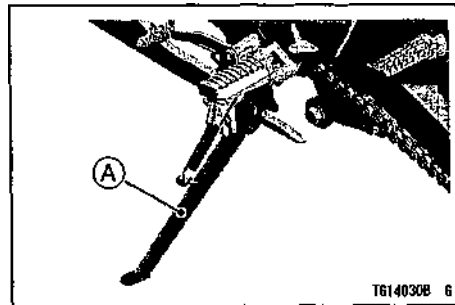

A. Side Stand

NOTE

O When using the side stand, turn the handlebar to the left.

Whenever the side stand is used, make it a practice to kick the stand fully up before sitting on the motorcycle.

NOTE

O The motorcycle is equipped with a side stand switch. This switch is designed so that the engine does not start if the transmission is in gear and the side stand is down.

Seats

Passenger's Seat Removal

Remove the passenger's seat by inserting the ignition key into the seat lock, and turning it clockwise.

Pull up the rear of the seat, and remove the passenger's seat by pushing it to the front.

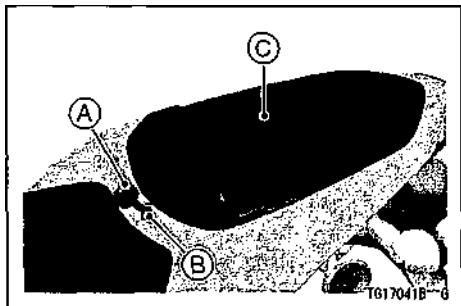

- A. Ignition Key
- B. Seat Lock
- C. Passenger's Seat

Rider's Seat Removal

- Remove the screw and the left and right side covers.
- Pull the left and right side covers to the front for detaching the stopper of the side cover from the holder at the fuel tank while pulling the projections out.

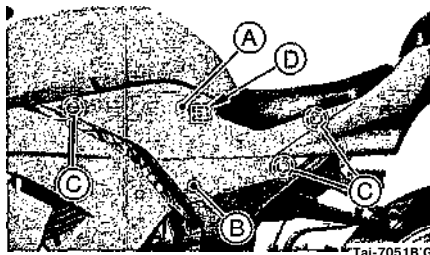

- A. Side Cover (Left Side)
- B. Screw
- C. Projections
- D. Holder

- Remove the bolts and pull off the seat to the up and rear.

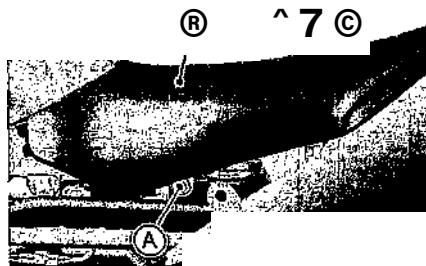

- A. Bolt
- B. Rider's Seat
- C. Pull Up and Rear

Seat Installation

Install the rider's and passenger's seats in the reverse order of removal.

Rider's Seat -

- Insert the tabs on the rear of the rider's seat into the slots on the frame and tighten the bolts.

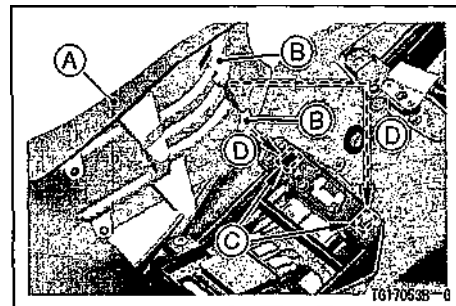

- A. Rider's Seat
- B. Tabs
- C. Slots
- D. Insert

- Install the left and right side covers and tighten screw.

NOTE

O When installing the left and right side covers, fit the stopper of the side cover to the holder at the fuel tank, and insert the projections.

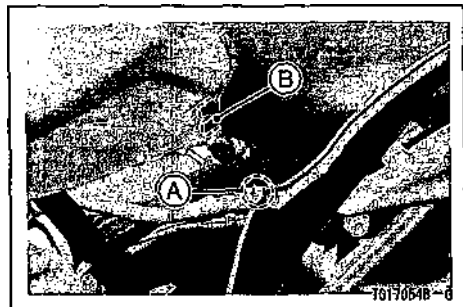

- A. Stopper
- B. Holder

Passenger's Seat -

- Insert the tab of the bracket into the slot in the rear of the passenger's seat.
- Insert the projection at the front of the passenger's seat into the slot on the frame.

- Push down the front part of the passenger's seat until the lock clicks.

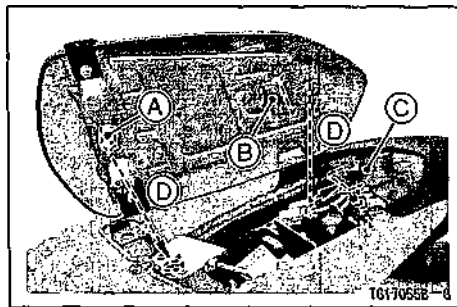

- A. Projection
- B. Slot
- C. Tab
- D. Insert

- Pull up the front and rear ends of the passenger's and rider's seats to make sure they are securely locked.

Helmet Hooks

Helmets can be secured to the motorcycle using the helmet hooks located under the passenger's seat.

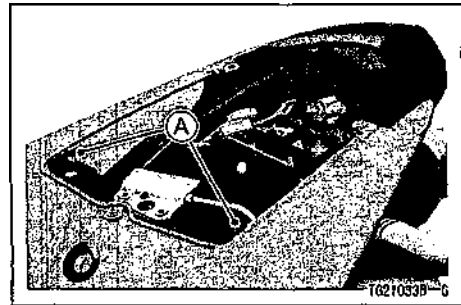

- A. Helmet Hooks

WARNING

Do not ride the motorcycle with helmets attached to the hooks. The helmets could cause an accident by distracting the operator or interfering with normal vehicle operation.

Tool Kit

The tool kit is located under the passenger's seat.

Store the tool kit in the compartment provided. The kit contains tools that can be helpful in making roadside repairs, adjustments, and some maintenance procedures explained in this manual.

The tool kit should be fixed by the tool kit cover.

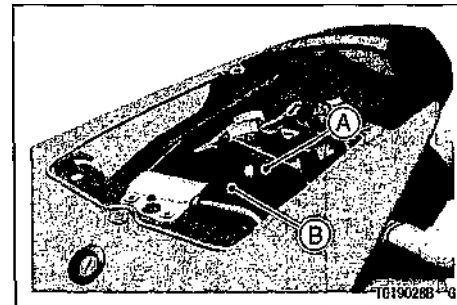

A. Tool Kit
B. Tool Kit Cover

Tying Hooks

When tying up light loads to the seat, use the tying hooks located on the left and right sides of the rear fairsing.

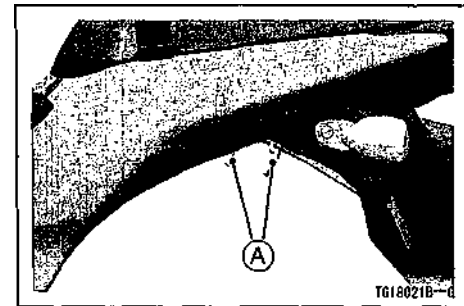

A. Tying Hooks

 BREAK-IN

The first 1,600 km (1,000 mi) that the motorcycle is ridden is designated as the break-in period. If the motorcycle is not used carefully during this period, you may very well end up with a "broken down" instead of a "broken in" motorcycle after a few thousand kilometers.

The following rules should be observed during the break-in period.

- The table shows maximum recommended engine speed during the break-in period.

Distance traveled	Maximum engine speed
0 ~ 800 km (0 ~ 500 mi)	4 000 r/min (rpm)
800 ~ 1 600 km (500 ~ 1 000 mi)	6 000 r/min (rpm)

- Do not start moving or race the engine immediately after starting it, even if the engine is already warm. Run the engine for two or three minutes at idle speed to give the oil a chance to work up into all the engine parts.
- Do not race the engine while the transmission is in neutral.

WARNING

New tires are slippery and may cause loss of control and injury. A break-in period of 160 km (100 miles) is necessary to establish normal tire traction. During break-in, avoid sudden and maximum braking and acceleration, and hard cornering.

In addition to the above, at 1 000 km (600 mi) it is extremely important that the owner have the initial maintenance service performed by an authorized Kawasaki dealer.

HOW TO RIDE THE MOTORCYCLE

Starting the Engine

- Check that the engine stop switch is in the o position.
- Turn the ignition key to "ON".
- Make sure the transmission is in neutral.

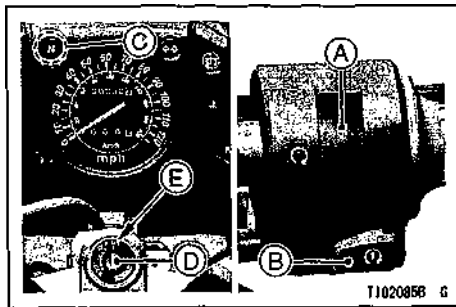

- A. Engine Stop Switch
- B. Starter Button
- C. Neutral Indicator Light
- D. Ignition Switch
- E. ON position

NOTE

O The motorcycle is equipped with a vehicle-down sensor, which causes the engine to stop automatically.

- Leaving the throttle completely closed, push the starter button.

CAUTION

Do not operate the starter continuously for more than 5 seconds or the starter will overheat and the battery power will drop temporarily. Wait 15 seconds between each operation of the starter to let it cool and the battery power recover.

NOTE

O The motorcycle is equipped with a starter lockout switch. This switch is designed so that the engine does not start if the transmission is in gear and the side stand is down. However, the engine can be started if the clutch

lever is pulled and the side stand is fully up.

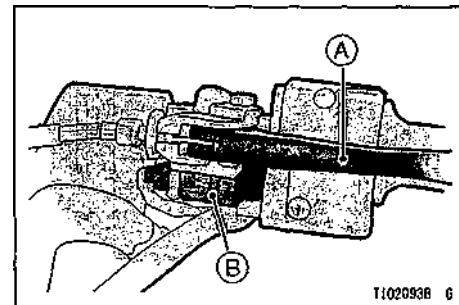

- A. Clutch Lever
- B. Starter Lockout Switch

CAUTION

Do not let the engine idle longer than five minutes, or engine overheating and damage may occur.

Jump Starting

If your motorcycle battery is "run down," it should be removed and charged. If this is not practical, a 12 volt booster battery and jumper cables may be used to start the engine.

⚠ WARNING

Battery acid generates hydrogen gas which is flammable and explosive under certain conditions. It is present within a battery at all times, even in a discharged condition. Keep all flames and sparks (cigarettes) away from the battery. Wear eye protection when working with a battery. In the event of battery acid contact with skin, eyes, or clothing, wash the affected areas immediately with water for at least five minutes. Seek medical attention.

Connecting Jumper Cables

- Remove side covers and the rider's seat.
- Make sure the ignition key is turned to OFF.

- Remove the battery cover. (Refer to the Battery section of the "Maintenance and Adjustment" chapter.)
- Connect a jumper cable from the positive (+) terminal of the booster battery to the positive (+) terminal of the motorcycle battery.

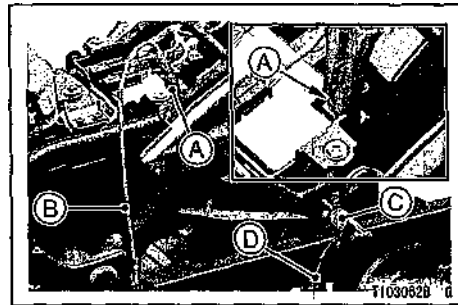

- A. Motorcycle Battery Positive (+) Terminal
- B. From Booster Battery Positive (+) Terminal
- C. Unpainted Metal Surface
- D. From Booster Battery Negative (-) Terminal

- Connect another jumper cable from the negative (-) terminal of the booster battery to your motorcycle shift pedal or other unpainted metal surface. Do not use the negative (-) terminal of the battery.

⚠ WARNING

Do not make this last connection at the fuel system or battery. Take care that you do not touch the positive and negative cables together, and do not lean over the battery when making this last connection. Do not jump start a frozen battery. It could explode. Do not reverse polarity by connecting positive (+) to negative (-) or a battery explosion and serious damage to the electrical system may occur.

- Follow the standard engine starting procedure.

CAUTION

Do not operate the starter continuously for more than 5 seconds or the starter will overheat and the battery power will drop temporarily. Wait 15 seconds between each operation of the starter to let it cool and the battery power recover.

- After the engine has started, disconnect the jumper cables. Disconnect the negative (-) cable from the motorcycle first.
- Reinstall the parts removed.

Moving Off

- Check that the side stand is up.
- Pull in the clutch lever.
- Shift into 1st gear.
- Open the throttle a little, and start to let out the clutch lever very slowly.
- As the clutch starts to engage, open the throttle a little more, giving the engine just enough fuel to keep it from stalling.

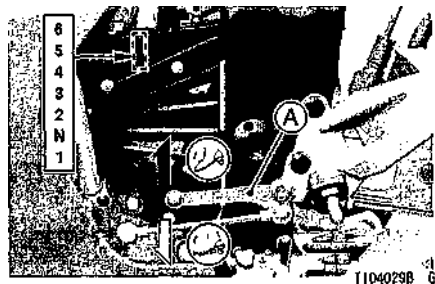

A. Shift Pedal

NOTE

- O The motorcycle is equipped with a side stand switch. This switch is designed so that the engine does not start if the transmission is in gear and the side stand is down.*
- O When the headlight is on high beam, two headlight beams are lit, and on low beam, one headlight is lit.*

Shifting Gears

- Close the throttle while pulling in the clutch lever.
- Shift into the next higher or lower gear.
- Open the throttle part way, while releasing the clutch lever.

⚠ WARNING

When shifting down to a lower gear, do not shift at such a high speed that the engine r/min (rpm) jumps excessively. Not only can this cause engine damage, but the rear wheel may skid and cause an accident. Downshifting should be done below 5,000 r/min (rpm) for each gear.

NOTE

O *The transmission is equipped with a positive neutral finder. When the motorcycle is standing still, the transmission cannot be shifted past neutral from 1st gear. To use the positive neutral finder, shift down to 1st gear, then lift up on the shift pedal while standing still. The transmission will shift only into neutral.*

Braking

- Close the throttle completely, leaving the clutch engaged (except when shifting gears) so that the engine will help slow down the motorcycle.
- Shift down one gear at a time so that you are in 1st gear when you come to a complete stop.
- When stopping, always apply both brakes at the same time. Normally the front brake should be applied a little more than the rear. Shift down or fully disengage the clutch as necessary to keep the engine from stalling.
- Never lock the brakes, or it will cause the tires to skid. When turning a corner, it is better not to brake at all. Reduce your speed before you get into the corner.
- For emergency braking, disregard downshifting, and concentrate on

applying the brakes as hard as possible without skidding.

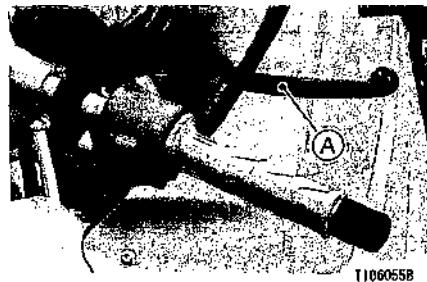

A. Front Brake Lever

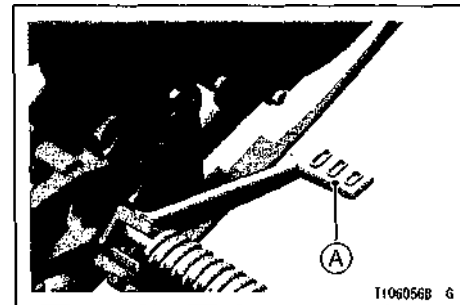

A. Rear Brake Pedal

Stopping the Engine

- Close the throttle completely.
- Shift the transmission into neutral.
- Turn the ignition key to "OFF".
- Support the motorcycle on a firm, level surface with the side stand.
- Lock the steering.

NOTE

O The motorcycle is equipped with a vehicle-down sensor, which causes the engine to stop automatically.

Stopping the Motorcycle in an Emergency

Your Kawasaki Motorcycle has been designed and manufactured to provide you optimum safety and convenience. However, in order to fully benefit from Kawasaki's safety engineering and craftsmanship, it is essential that you, the owner and operator, properly maintain your motorcycle and become thoroughly familiar with its operation. Improper maintenance can create a dangerous situation known as throttle failure. Two of the most common causes of throttle failure are:

1. An improperly serviced or clogged air cleaner may allow dirt and dust to enter the throttle body and stick the throttle open.
2. During removal of the air cleaner, dirt is allowed to enter and jam the throttle body.

In an emergency situation such as throttle failure, your vehicle may be stopped by applying the brakes and disengaging the clutch. Once this stopping procedure is initiated, the engine stop switch may be used to stop the engine. If the engine stop switch is used, turn off the ignition switch after stopping the motorcycle.

Parking

- Shift the transmission into neutral and turn the ignition key to "OFF".
- Support the motorcycle on a firm, level surface with the side stand.

CAUTION

Do not park on a soft or steeply inclined surface, or the motorcycle may fall over.

- If parking inside a garage or other structure, be sure it is well ventilated and the motorcycle is not close to any source of flame or sparks; this includes any appliance with a pilot light.

WARNING

The muffler and exhaust pipe are very hot while the engine is running and just after the engine stop. This can ignite a fire, resulting in property damage or severe personal injury.

Do not idle or park your vehicle in an area where flammable materials such as grasses or dry leaves may contact with muffler or exhaust pipe.

WARNING

Gasoline is extremely flammable and can be explosive under certain conditions.

- Lock the steering to help prevent theft.

Catalytic Converter

This motorcycle is equipped with a catalytic converter in the exhaust system. Platinum and rhodium in the converter react with carbon monoxide and hydrocarbons to convert them into carbon dioxide and water resulting in much cleaner exhaust gases to be discharged into the atmosphere.

For proper operation of the catalytic converter, the following cautions must be observed.

WARNING

The muffler and exhaust pipe are very hot while the engine is running and just after the engine stop. This can ignite a fire, resulting in property damage or severe personal injury.

Do not idle or park your vehicle in an area where flammable materials such as grasses or dry leaves may contact with muffler or exhaust pipe.

- Use only unleaded gasoline. Never use leaded gasoline. Leaded gasoline significantly reduces the capability of the catalytic converter.
- Do not coast the vehicle with the ignition switch and/or engine stop switch off. Do not attempt to start the engine by rolling the vehicle if the battery is discharged. Do not operate

the vehicle with the engine or any one cylinder misfiring. Under these conditions unburned air/fuel mixture flowing out of engine excessively accelerates reaction in the converter allowing the converter to overheat and

become damaged when the engine is hot, or reduces converter performance when the engine is cold,

Safe Riding Technique

The points given below are applicable for everyday motorcycle use and should be carefully observed for safe and effective vehicle operation.

For safety, eye protection and a helmet are strongly recommended. Gloves and suitable footwear should also be used for added protection in case of a mishap.

A motorcycle does not provide the impact protection of an automobile, so defensive riding in addition to wearing protective apparel is extremely important. Do not let protective apparel give you a false sense of security.

Before changing lanes, look over your shoulder to make sure the way

SAFE OPERATION

is clear. Do not rely solely on the rear view mirror; you may misjudge a vehicle's distance and speed, or you may not see it at all.

When going up steep slopes, shift to a lower gear so that there is plenty of power to spare rather than overloading the engine.

When applying the brakes, use both the front and rear brakes. Applying only one brake for sudden braking may cause the motorcycle to skid and lose control.

When going down long slopes, control vehicle speed by closing the throttle. Use the front and rear brakes for auxiliary braking.

On rainy days, rely more on the throttle to control vehicle speed and less on the front and rear brakes. The throttle should also be used judiciously to avoid skidding the rear wheel from too rapid acceleration or deceleration.

Riding at the proper rate of speed and avoiding unnecessarily fast acceleration are important not only for safety and low fuel consumption but also for long vehicle life and quieter operation.

When riding in wet conditions or on loose roadway surfaces, the ability to maneuver will be reduced. All

of your actions should be smooth under these conditions. Sudden acceleration, braking or turning may cause loss of control.

On rough roads, exercise caution, slow down, and grip the fuel tank with the knees for better stability.

When quick acceleration is necessary as in passing, shift to a lower gear to obtain the necessary power.

Do not downshift at too high an r/min (rpm) to avoid damage to the engine from overrevving.

Avoiding unnecessary weaving is important to the safety of both the rider and other motorists.

Daily Safety Checks

Check the following items each day before you ride. The time required is minimal, and habitual performance of these checks will help ensure you a safe, reliable ride.

If any irregularities are found during these checks, refer to the Maintenance and Adjustment chapter or see your dealer for the action required to return the motorcycle to a safe operating condition.

WARNING

Failure to perform these checks every day before you ride may result in serious damage or a severe accident.

Fuel.....Adequate supply in tank, no leaks.
 Engine oil.....Oil level between level lines.
 Tires.....Air pressure (when cold):

Front	Up to 170 kg (375 lb) Load	200 kPa (2.00 kg/cm ² , 28 psi)
Rear	Up to 170 kg (375 lb) Load	225 kPa (2.25 kg/cm ² , 32 psi)

Install the air valve cap.

Drive chain.....	Slack 20 ~ 30 mm (0.8 ~ 1.2 in.) Lubricate the drive chain if dry.
Nuts, bolts, fasteners ..	Check that steering and suspension components, axles, and all controls are properly tightened or fastened.
Steering.....	Action smooth but not loose from lock to lock. No binding of control cables.
Brakes.....	Brake pad wear: Lining thickness more than 1 mm (0.04 in.) left. No brake fluid leakage.
Throttle.....	Throttle grip play 2 ~ 3 mm (0.08 ~ 0.12 in.).
Clutch.....	Clutch lever play 2 ~ 3 mm (0.08 ~ 0.12 in.). Clutch lever operates smoothly.
Coolant.....	No coolant leakage. Coolant level between level lines (when engine is cold).
Electrical equipment ...	All lights (Headlight, Tail/Brake Lights, Turn Signal Lights, Warning/Indicator Lights) and horn work.
Engine stop switch.	Stops engine.
Side stand.....	Returns to its fully up position by spring tension. Returns spring not weak or not damaged.

Refer to the "Daily Safety Checks" caution label attached to the passenger's seat.

Additional Considerations for High Speed Operation

Brakes: The importance of the brakes, especially during high speed operation, cannot be overemphasized. Check to see that they are correctly adjusted and functioning properly.

Steering: Looseness in the steering can cause loss of control. Check to see that the handlebar turns freely but has no play.

Tires: High speed operation is hard on tires, and good tires are crucial for riding safety. Examine their overall condition, inflate them to the proper pressure, and check the wheel balance.

Fuel: Have sufficient fuel for the high fuel consumption during high speed operation.

Engine Oil: To avoid engine seizure and resulting loss of control, make sure that the oil level is at the upper level line.

Coolant: To avoid overheating, check that the coolant level is at the upper level line.

Electrical Equipment: Make sure that the headlight, tail/brake light, turn signals, horn, etc., all work properly.

Miscellaneous: Make sure that all nuts and bolts are tight and that all safety related parts are in good condition.

WARNING

Handling characteristics of a motorcycle at high speeds may vary from those you are familiar with at legal highway speeds. Do not attempt high speed operation unless you have received sufficient training and have the required skills.

MAINTENANCE AND ADJUSTMENT

The maintenance and adjustments outlined in this chapter must be carried out and must be done in accordance with the Periodic Maintenance Chart to keep the motorcycle in good running condition. **The initial maintenance is vitally important and must not be neglected.**

With a basic knowledge of mechanics and the proper use of tools, you should be able to carry out many of the maintenance items described in this chapter. If you lack proper experience or doubt your ability, all adjustments, maintenance, and repair work should be completed by a qualified technician.

Please note that Kawasaki cannot assume any responsibility for damage resulting from incorrect or improper adjustment done by the owner.

Periodic Maintenance Chart

1. Periodic Inspection (Engine Related Items)

Operation (Engine Items)	Frequency	*Odometer Reading km x 1 000 (mile * 1 000)							See Page
	Whichever comes first ↓	1 (0.6)	6 (4)	12 (7.5)	18 (12)	24 (15)	30 (20)	36 (24)	
Air cleaner element - clean	Every			•		•		•	83
K Valve clearance - inspect				•		•		•	83
Throttle control system (play, smooth return, no drag) - inspect	year	•		•		•		•	87
„ Engine vacuum synchronization - inspect				•		•		•	90
Idle speed - inspect		•		•		•		•	91
Fuel leak (fuel hose and pipe) - inspect	year	•		•		•		•	-

Operation (Engine Items)	Frequency	*Odometer Reading km x 1 000 (mile x 1 000)							See Page
	Whichever comes first ↓	1 (0.6)	6 (4)	12 (7.5)	18 (12)	24 (15)	30 (20)	36 (24)	
Fuel hoses damage - inspect	year	•		•		•		•	-
Fuel hoses installation condition - inspect	year	•		•		•		•	-
Coolant level - inspect		•		•		•		•	77
Coolant leak - inspect	year	•		•		•		•	75
Radiator hose damage - inspect	year	•		•		•		•	75
Radiator hoses installation condition - inspect	year	•		•		•		•	75
κ Air suction system damage - inspect				•		•		•	82

Frequency	Whichever comes first ↓	*Odometer Reading km x 1000 (mile x 1000)							See Page
		1 (0.6)	6 (4)	12 (7.5)	18 (12)	24 (15)	30 (20)	36 (24)	
Operation (Chassis Items)	Every								
Brake fluid level - inspect	6 months	•	•	•	•	•	•	•	103
Brake operation (effectiveness, play, drag) - inspect	year	•	•	•	•	•	•	•	106
Brake light switch operation - inspect		•	•	•	•	•	•	•	107
Suspensions:									
Front forks/rear shock absorber operation (damping and smooth stroke) - inspect				•		•		•	109,110
Front forks/rear shock absorber oil leak - inspect	year			•		•		•	109,110

Frequency	Whichever comes first ↓	*Odometer Reading km x 1000 (mile * 1000)							See Page
		1 (0.6)	6 (4)	12 (7.5)	18 (12)	24 (15)	30 (20)	36 (24)	
Operation (Chassis items)	Every								
Uni-trak rocker arm operation - inspect				•				•	-
Uni-trak tie rods operation - inspect				•				•	-
K Swingarm pivot lubricate									-
Steering System:									
K Steering play - inspect	year	•		•				•	-
_K Steering stem bearings - lubricate	2 years								-
Electrical System:									
Lights and switches operation - inspect	year			•		•		•	-

Frequency	Whichever comes first		*Odometer Reading km x 1000 (mile x 1000)						See Page
	↓	→	1 (0.6)	6 (4)	12 (7.5)	18 (12)	24 (15)	30 (20)	
Operation (Chassis Items)	Every								
Headlight aiming - inspect	year			•		•		•	123
Side stand switch operation - inspect	year			•		•		•	-
Engine stop switch operation - inspect	year			•		•		•	-
Chassis:									
K Chassis parts - lubricate	year			•		•		•	-
^κ Bolts and nuts tightness - inspect		•		•		•		•	-

3. Periodic Replacement

Frequency	Whichever comes first		*Odometer Reading km x 1 000 (mile * 1 000)					See Page
	↓	→	1 (0.6)	12 (7.5)	24 (15)	36 (24)	48 (30)	
Change/Replacement Items	Every							
K Air cleaner element #	2 year						83	
Engine oil #	year	•	•	•	•	•	71	
Oil filter	year	•	•	•	•	•	71	
K Fuel hoses	4 year					•	-	
K Coolant	3 years				•		80	
K Radiator hoses and O-rings	3 years				•		-	
K Brake hoses	4 years					•	-	
K Brake fluid (front and rear)	2 years			•		•	106	

Change/Replacement Items	Frequency Whichever comes first ↓ Every	*Odometer Reading km x 1 000 (mile x 1 000) →					See Page
		1 (0.6)	12 (7.5)	24 (15)	36 (24)	48 (30)	
^K Rubber parts of master cylinder and caliper	4 years					•	-
K Spark plug			•	•	•	•	81

K: Should be serviced by an authorized Kawasaki dealer.

*: For higher odometer readings, repeat at the frequency interval established here.

#: Service more frequently when operating in severe conditions: dusty, wet, muddy, high speed, or frequent starting/stopping.

Engine Oil

In order for the engine, transmission, and clutch to function properly, maintain the engine oil at the proper level, and change the oil and replace the oil filter in accordance with the Periodic Maintenance Chart. Not only do dirt and metal particles collect in the oil, but the oil itself loses its lubricative quality if used too long.

WARNING

Motorcycle operation with insufficient, deteriorated, or contaminated engine oil will cause accelerated wear and may result in engine or transmission seizure, accident, and injury.

Oil Level Inspection

- If the oil has just been changed, start the engine and run it for several minutes at idle speed. This fills the oil filter with oil. Stop the engine, then wait several minutes until the oil settles.

CAUTION

Racing the engine before the oil reaches every part can cause engine seizure.

- If the motorcycle has just been used, wait several minutes for all the oil to drain down.

- Check the engine oil level through the oil level gauge. With the motorcycle held level, the oil level should come up between the upper and lower level lines next to the gauge.

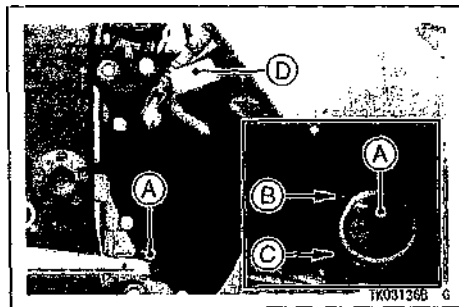

- A. Oil Level Gauge
- B. Upper Level Line
- C. Lower Level Line
- D. Oil Filler Cap

- If the oil level is too high, remove the excess oil through the oil filler opening using a syringe or some other suitable device.
- If the oil level is too low, add the oil to reach the correct level. Use the same type and brand of oil that is already in the engine.

CAUTION

If the engine oil gets extremely low or if the oil pump does not function properly or oil passages are clogged, the warning light will light.

CAUTION

If this light stays on when the engine speed is slightly above the idle speed, stop the engine immediately and find the cause.

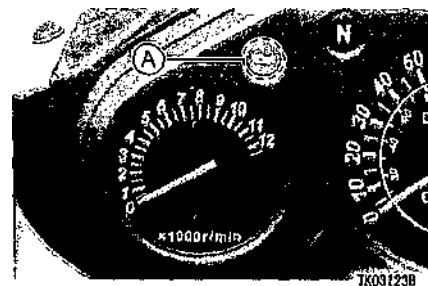

- A. Oil Pressure Warning Light

Oil and/or Oil Filter Change

- Warm up the engine thoroughly, and then stop it.

- Place an oil pan beneath the engine.
- Remove engine oil drain plug.

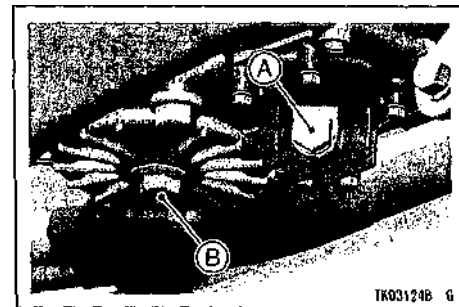

- A. Engine Oil Drain Plug
- B. Oil Filter Mounting Bolt

- Let the oil completely drain with the motorcycle perpendicular to the ground.

WARNING

Motor oil is a toxic substance. Dispose of used oil properly. Contact your local authorities for approved disposal methods or possible recycling.

- If the oil filter is to be replaced, remove the oil filter mounting bolt and drop out the oil filter.
- Replace the oil filter element with a new one.

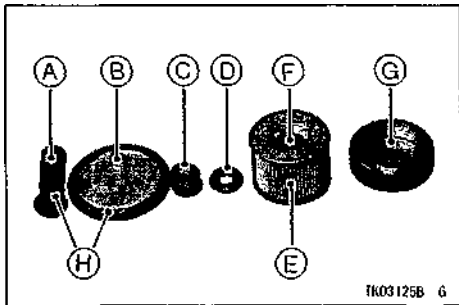

- A. Mounting Bolt
 B. Filter Cover
 C. Spring
 D. Flat Washer
 E. Element
 F. Grommet
 G. Element Fence
 H. O-Ring

NOTE

- O* Replace the O-rings with new ones.
- O* When installing the oil filter, make sure the O-rings are in place.

- Apply a little engine oil to the O-ring on the filter mounting bolt, fit the filter cover on the bolt, and install the spring and flat washer.
- Apply a little engine oil to the grommets on both sides of the element, and turn the filter to work the element into place. Be careful that the element grommets do not slip out of place.
- Install the element fence on the bolt.
- Install the oil filter, tightening its mounting bolt to the specified torque.
- After the oil has completely drained out, install the engine oil drain plug with a new gasket. Proper torque for it is shown in the table.

NOTE

- O* Replace any gasket with a new one.

- Fill the engine up to the upper level line with a good quality engine oil specified in the table.
- Start the engine.
- Check the oil level and for oil leakage.

Tightening Torque

- Engine Oil Drain Plug:
 19.6 N-m (2.0 kg-m, 14.5 ft-lb)
 Oil Filter Mounting Bolt:
 19.6 N-m (2.0 kg-m, 14.5 ft-lb)

NOTE

- O* If a torque wrench is not available, this item should be serviced by a Kawasaki dealer.

Recommended Engine Oil

Type:	API SE, SF or SG API SH, SJ or SL with JASO MA
Viscosity:	SAE 10W-40

Engine Oil Capacity

Capacity:	1.3 L (1.4 US qt) [when filter is not removed]
	1.6L(1.7USqt) [when filter is removed]
	1.7 L (1.8 US qt) [when engine is completely dry]

Although 10W-40 engine oil is the recommended oil for most conditions, the oil viscosity may need to be changed to accommodate atmospheric conditions in your riding area.

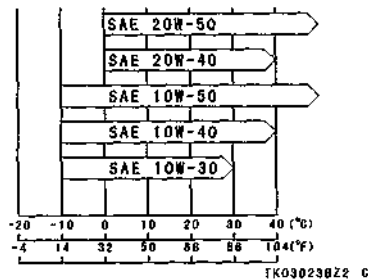
**Cooling System****Radiator and Cooling Fan -**

Check the radiator fins for obstruction by insects or mud. Clean off any obstructions with a stream of low-pressure water.

WARNING

Keep your hands and clothing away from the fan blades at all times.

CAUTION

Using high-pressure water, as from a Gar wash facility, could damage the radiator fins and impair the radiator's effectiveness. Do not obstruct or deflect airflow through the radiator by installing unauthorized accessories in front of the radiator or behind the cooling fan. Interference with the radiator airflow can lead to overheating and consequent engine damage.

Radiator Hoses -

Check the radiator hoses for leakage, cracks or deterioration, and connections for leakage or looseness each day before riding the motorcycle, and in accordance with the Periodic Maintenance Chart.

Coolant -

Coolant absorbs excessive heat from the engine and transfers it to the air at the radiator. If the coolant level becomes low, the engine overheats and may suffer severe damage. Check the coolant level each day before riding the motorcycle, and in accordance with the periodic maintenance chart and replenish coolant if the level is low. Change the coolant in accordance with the Periodic Maintenance Chart.

Information for Coolant

To protect the cooling system (consisting of the aluminum engine and radiator) from rust and corrosion, the use of corrosion and rust inhibitor chemicals in the coolant is essential. If coolant containing corrosion and rust

inhibitor chemicals is not used, over a period of time, the cooling system accumulates rust and scale in the water jacket and radiator. This will clog up the coolant passages, and considerably reduce the efficiency of the cooling system.

WARNING

Use coolant containing corrosion inhibitors made specifically for aluminum engines and radiators in accordance with the instructions of the manufacturer. Chemicals are harmful to the human body.

Soft or distilled water must be used with the antifreeze (see below for antifreeze) in the cooling system.

CAUTION

If hard water is used in the system, it causes scale accumulation in the water passages, and considerably reduces the efficiency of the cooling system.

If the lowest ambient temperature encountered falls below the freezing point of water, use permanent antifreeze in the coolant to protect the cooling system against engine and radiator freeze-up, as well as from rust and corrosion.

Use a permanent type of antifreeze (soft water and ethylene glycol plus corrosion and rust inhibitor chemicals for aluminum engines and radiators) in the cooling system. On the mixture ratio of coolant, choose the suitable one referring to the relation between freezing point and strength directed on the container.

CAUTION

Permanent types of antifreeze on the market have anti-corrosion and anti-rust properties. When it is diluted excessively, it loses its anti-corrosion property. Dilute a permanent type of antifreeze in accordance with the instructions of the manufacturer.

NOTE

○ *A permanent type of antifreeze is installed in the cooling system when shipped. It is colored green and contains ethylene glycol. It is mixed at 50% and has the freezing point of -35°C (-31 °F).*

Coolant Level Inspection

- Situate the motorcycle so that it is perpendicular to the ground.

- Check the coolant level if it is between the F (Full) and L (Low) level lines.

NOTE

- Check the level when the engine is cold (room or atmospheric temperature).

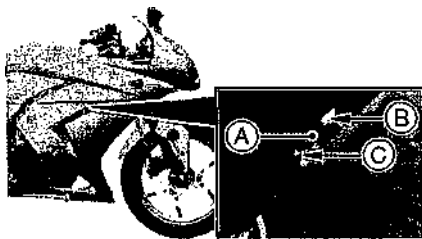

TK04074B 6

- A. Reserve Tank
- B. F (Full) Level Line
- C. L (Low) Level Line

- If the amount of coolant is insufficient, remove the right side cover and add coolant into the reserve tank.

Coolant Filling

- Remove the right side cover by removing the screw.
- Pull the right side cover to the front for detaching the stopper of the side cover white pulling the projections out.

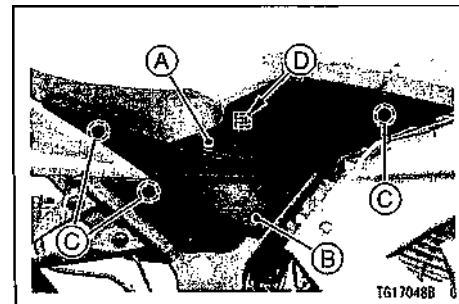

- A. Right Side Cover
- B. Screw
- C. Projections
- D. Holder

- Remove the cap from the reserve tank and add coolant through the filler opening to the F (Full) level line.

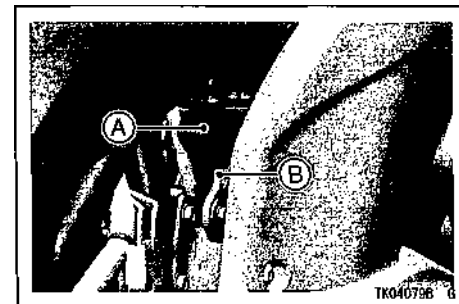

- A. Cap
- B. Reserve Tank

- Install the cap.
- Install the right side cover and tighten the bolt.

NOTE

- When installing the right side cover, fit the stopper of the cover to the holder at the fuel tank, and insert the projections.

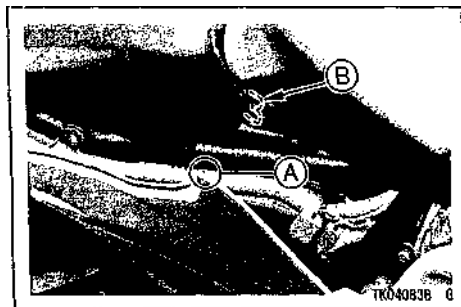

A. Stopper
B. Holder

NOTE

- In an emergency you can add water alone to the coolant reserve tank, however it must be returned to the correct mixture ratio by the addition of antifreeze concentrate as soon as possible.

CAUTION

If coolant must be added often, or the reserve tank completely runs dry, there is probably leakage in the system. Have the cooling system inspected by your authorized Kawasaki dealer.

Coolant Change

Have the coolant changed by an authorized Kawasaki dealer.

Spark Plugs

The standard spark plug is shown in the table. The spark plugs should be replaced in accordance with the Periodic Maintenance Chart.

Spark plug removal should be done only by an authorized Kawasaki dealer.

Spark Plug

Standard Plug	NGK CR8E
Plug Gap	0.7 - 0.8 mm (0.028 ~ 0.032 in.)
Tightening Torque	13 Nm (1.3kgf-m, 10 ftlb)

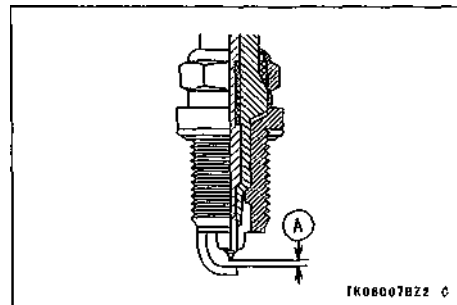

A. Plug Gap

TK06007BZZ ©

Kawasaki Clean Air System

The Kawasaki Clean Air System (KCA) is a secondary air suction system that helps the exhaust gases to burn more completely. When the spent fuel charge is released into the exhaust system, it is still hot enough to burn. The KCA System allows extra air into the exhaust system so that the spent fuel charge can continue to burn. This continued burning action tends to burn up a great deal of the normally unburned gases, as well as changing a significant portion of the carbon monoxide into carbon dioxide.

Air Suction Valves -

The air suction valve is essentially a check valve which allows fresh air to flow only from the air cleaner into the exhaust port. Any air that has passed

the air suction valve is prevented from returning. Inspect the air suction valves in accordance with the Periodic Maintenance Chart. Also, inspect the air suction valves whenever stable idling cannot be obtained, engine power is greatly reduced, or there are abnormal engine noises.

Air suction valve removal and inspection should be done only by an authorized Kawasaki dealer.

Valve Clearance

Valve and valve seat wear decreases valve clearance, upsetting valve timing.

CAUTION

If valve clearance is left unadjusted, wear will eventually cause the valves to remain partly open, which lowers performance, burns the valves and valve seats, and may cause serious engine damage.

Valve clearance for each valve should be checked and adjusted in accordance with the Periodic Maintenance Chart.

Inspection and adjustment should be done only by an authorized Kawasaki dealer.

Air Cleaner

A clogged air cleaner restricts the engine's air intake, increasing fuel consumption, reducing engine power, and causing spark plug fouling.

The air cleaner element must be cleaned in accordance with the Periodic Maintenance Chart. In dusty areas, the element should be cleaned more frequently than the recommended interval. After riding through rain or on muddy roads, the element should be cleaned immediately. The element should be replaced if it is damaged.

Element Removal

- Remove the right side cover.
- Unscrew the air cleaner element cap mounting bolts, then remove the air cleaner element cap.

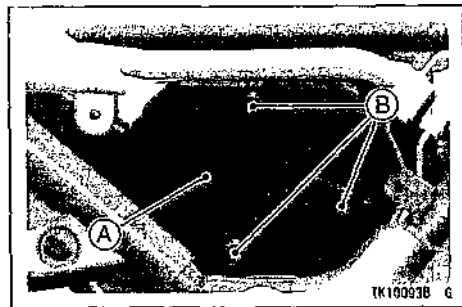

A. Air Cleaner Element Cap
B. Mounting Bolts

- Pull out the air cleaner element from the air cleaner housing.

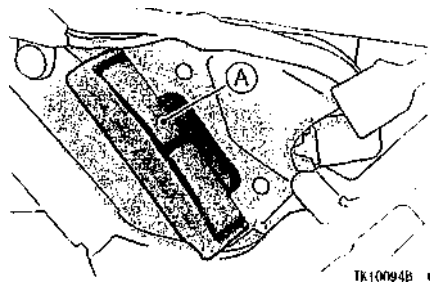

A. Element

- Remove the element from the frame.

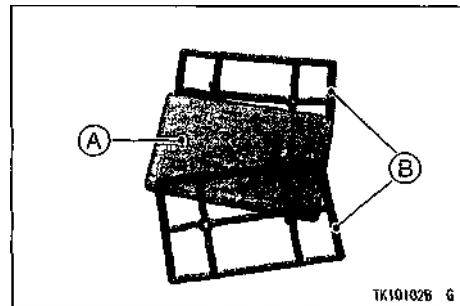

A. Element
B. Frame

- Push a clean, lint-free towel into the air cleaner housing to keep dirt or other foreign material from entering.
- Inspect the element material for damage. If any part of the element is damaged, the element must be replaced.

WARNING

If dirt or dust is allowed to pass through into the throttle body, the throttle may become stuck, possibly causing an accident.

CAUTION

If dirt gets through into the engine, excessive engine wear and possibly engine damage will occur.

NOTE

Element installation is performed in the reverse order of removal.

Element Cleaning

- Clean the element in a bath of a high flash-point solvent.
- Dry the element with compressed air or by squeezing it.

- After cleaning, saturate the element with SE, SF or SG class SAE 30W motor oil, squeeze out the excess oil, then wrap it in a clean rag and squeeze it as dry as possible. Be careful not to tear the element.

WARNING

Clean the element in a well ventilated area, and take care that there are no sparks or flame anywhere near the working area; this includes any appliance with a pilot light. Do not use gasoline or a low flash-point solvent to clean the element. A fire or explosion could result.

Dust and/or Water Inspection

- Inspect the transparent drain cap located at the left lower end of the air

cleaner housing to see if any oil has run down from the air cleaner housing.

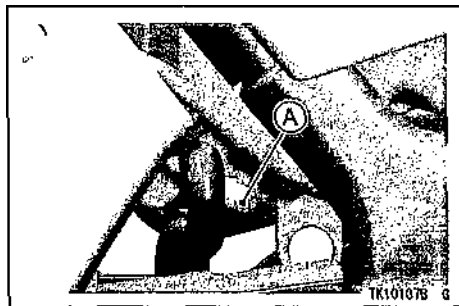

A. Drain Cap

- If there are any oil in the drain cap, remove the cap from the lower end of the air cleaner housing and drain the oil.

WARNING

Be sure to install the drain cap after draining. Oil on tires will make them slippery and can cause an accident and injury.

Throttle Control System

Check the throttle grip play in?, accordance with the Periodic Maintenance Chart, and adjust it if necessary.

Throttle Grip -

The throttle grip controls the butterfly valves in the throttle body. If the throttle grip has excessive play due to either cable stretch or maladjustment, it will cause a delay in throttle response, especially at low engine speed. Also, the throttle valve may not open fully at full throttle. On the other hand, if the throttle grip has not play, the throttle will be hard to control, and the idle speed will be erratic.

Inspection

- Check that the throttle grip play is correct by lightly turning the throttle grip back and forth.

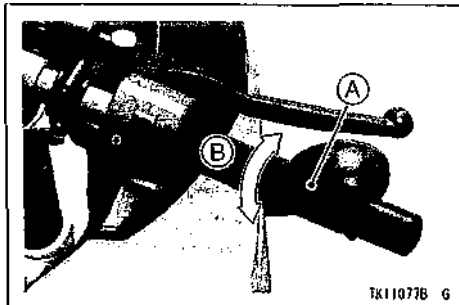

- A. Throttle Grip
B. Throttle Grip Play

Throttle Grip Play

2 - 3 mm (0.08 ~ 0.12 in.)

- If there is improper play, adjust it.

Adjustment

- Loosen the locknut at the throttle grip, and turn the adjuster until the proper amount of throttle grip play is obtained.

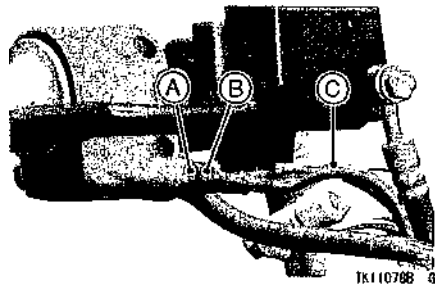

- A, Locknut
B. Adjuster
C Throttle Cable (Accelerator Cable)

- If the throttle cable can not be adjusted with the adjuster at the throttle grip, use the nuts located at the throttle body.

- Loosen the locknut at the throttle grip and turn in the adjuster fully.
- Tighten the locknut.
- Loosen the nuts at the throttle body, and screw both throttle cable nuts fully so as to give the throttle grip plenty of play.
- Turn the decelerator cable nut until there is no play when the throttle grip is completely closed. Tighten the nut.
- Turn the accelerator cable nut until 2 ~ 3 mm (0.08 - 0.12 in.) of throttle grip play is obtained. Tighten the nut.

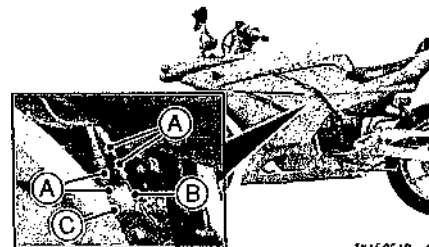

TK150510 G

- A. Nuts
B. Decelerator Cable
C Accelerator Cable

- With the engine idling, turn the handlebar to each side. If handlebar movement changes the idle speed, the throttle cables may be improperly adjusted or incorrectly routed, or they may be damaged. Be sure to correct any of these conditions before riding.

WARNING

Operation with an improperly adjusted, incorrectly routed, or damaged cables could result in an unsafe riding condition.

Engine Vacuum Synchronization

Engine vacuum synchronization must be checked and adjusted periodically in accordance with the Periodic Maintenance Chart by an authorized Kawasaki dealer.

NOTE

○ Poor engine vacuum synchronization will cause unstable idling, sluggish throttle response, and reduce engine power and performance.

Idle Speed

The idle speed adjustment should be performed in accordance with the Periodic Maintenance Chart or whenever the idle speed is disturbed.

Adjustment

- Start the engine, and warm it up thoroughly.
- Adjust the idle speed by turning the idle adjusting screw.

Idle Speed

1 250 ~ 1 350 r/min (rpm)

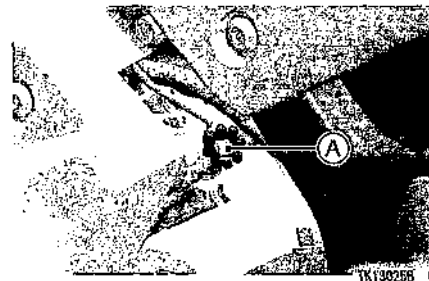

A. Idle Adjusting Screw

- Open and close the throttle a few times to make sure that the idle speed does not change. Readjust if necessary.
- With the engine idling, turn the handlebar to each side. If handlebar movement changes the idle speed, the throttle cables may be improperly adjusted or incorrectly routed, or they may be damaged. Be sure to correct any of these conditions before riding.

WARNING

Operation with damaged cables could result in an unsafe riding condition.

Clutch

Due to friction plate wear and clutch cable stretch over a long period of use, the clutch operation should be checked each day before riding the motorcycle, and in accordance with the Periodic Maintenance Chart.

WARNING

To avoid a serious burn, never touch a hot engine or an exhaust pipe during clutch adjustment.

Inspection

- Check that the clutch lever operates properly and that the inner cable slides smoothly. If there is any irregularity, have the clutch cable checked by an authorized Kawasaki dealer.
- Check the clutch lever play as shown in the figure.

Clutch Lever Play

2 - 3 mm (0.08-0.12 in.)

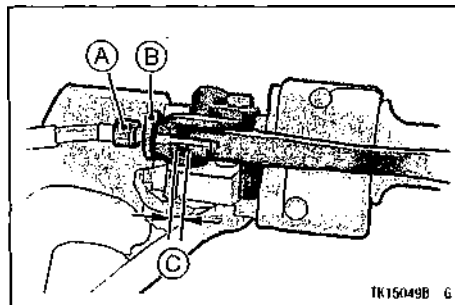

- A. Adjuster
- B. Locknut
- C. Clutch Lever Play

If the play is incorrect, adjust the lever play as follows.

Adjustment

- Loosen the locknut at the clutch lever.
- Turn the adjuster so that the clutch lever will have the specified free play.

WARNING

Be sure the upper end of the clutch outer cable is fully seated in its fitting, or it could slip into place later, creating enough cable play to prevent clutch disengagement, resulting in a hazardous riding condition.

- Tighten the locknut.
- If it cannot be done, use the mounting nuts at the lower end of the cable.

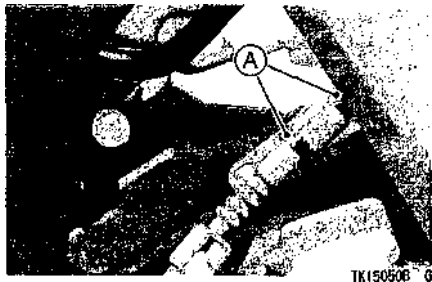

TK150506 G

A. Nuts

NOTE

After the adjustment is made, start the engine and check that the clutch does not slip and that it releases properly.

Drive Chain

The drive chain slack and lubrication must be checked each day before riding the motorcycle, and in accordance with the Periodic Maintenance Chart for safety and to prevent excessive wear. If the chain becomes badly worn or maladjusted - either too loose or too tight - the chain could jump off the sprockets or break.

WARNING

A chain that breaks or jumps off the sprockets could snag on the engine sprocket or lock the rear wheel, severely damaging the motorcycle and causing it to go out of control.

Chain Slack Inspection

- Set the motorcycle up on its side stand.

- Rotate the rear wheel to find the position where the chain is tightest, and measure the maximum chain slack by pulling up and pushing down the chain midway between the engine sprocket and rear wheel sprocket.

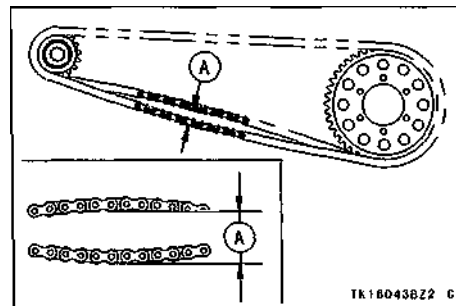

TK16043822 G

A. Chain Slack

- If the drive chain is too tight or too loose, adjust it so that the chain slack will be within the standard value.

Drive Chain Slack

Standard 20 ~ 30 mm (0.8 ~ 1.2 in.)

Chain Slack Adjustment

- Loosen the left and right chain adjuster locknuts.
- Remove the cotter pin, and loosen the rear axle nut.

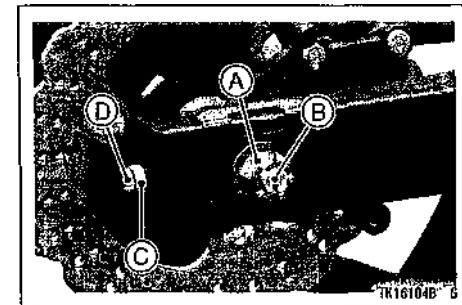

TK161046 G

A. Axle Nut
B. Cotter Pin
C. Adjusting Nut
D. Locknut

- If the chain is too loose, turn in the left and right chain adjusting nuts evenly.
- If the chain is too tight, turn out the left and right chain adjusting nuts evenly.
- Turn both chain adjusting nuts evenly until the drive chain has the correct amount of slack.

- To keep the chain and wheel properly aligned, the notch on the left wheel alignment indicator should align with the same swingarm mark that the right indicator notch aligns with.

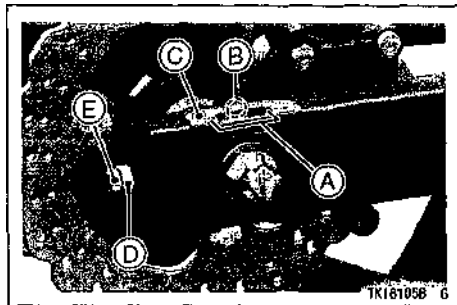

- A. Marks
B. Notch
C. Indicator
D. Adjusting Nut
E. Locknut

NOTE

Wheel alignment can also be checked using the straightedge or string method.

WARNING

Misalignment of the wheel will result in abnormal wear, and may result in an unsafe riding condition.

- Tighten both chain adjuster locknuts.
- Tighten the rear axle nut to the specified torque.

Tightening Torque

Axle Nut:

98N·m (10kgf·m, 72 ft·lb)

NOTE

If a torque wrench is not available, this item should be serviced by a Kawasaki dealer.

- Rotate the wheel, measure the chain slack again at the tightest position, and readjust if necessary.
- Install a new cotter pin through the rear axle nut and axle, and spread its ends.

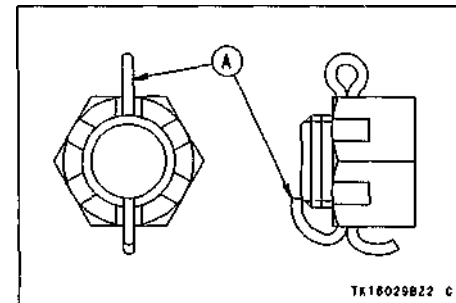

A. Cotter Pin

NOTE

- When inserting the cotter pin, if the slots in the nut do not align with the cotter pin hole in the axle shaft, tighten the nut clockwise up to the next alignment.
- It should be within 30 degree.
- Loosen once and tighten again when the slot goes past the nearest hole.

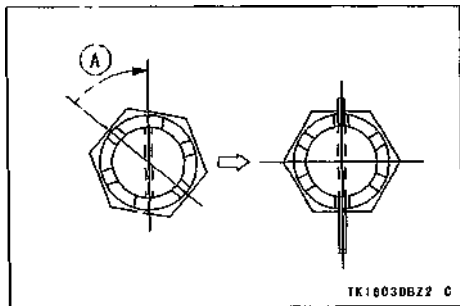

A. Turning Clockwise

WARNING

If the axle nut is not securely tightened or the cotter pin is not installed, an unsafe riding condition may result.

- Check the rear brake (see the Brakes section).

Wear Inspection

- Remove the bolts to take off the chain cover.

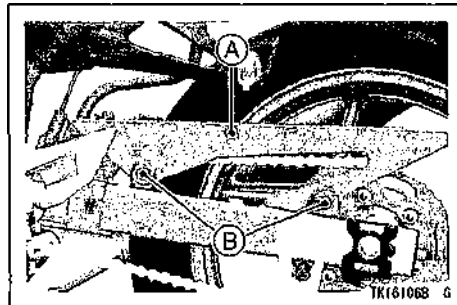

A. Chain Cover
B. Bolts

- Stretch the chain taut either by using the chain adjusters, or by hanging a 10 kg (20 lb) weight on the chain.
- Measure the length of 20 links on the straight part of the chain from pin center of the 1st pin to pin center of the 21st pin. Since the chain may

wear unevenly, take measurements at several places.

- If the length exceeds the service limit, the chain should be replaced.

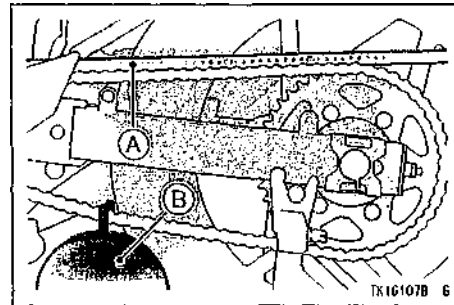

A. Measure
B. Weight

Drive Chain 20-Link Length Service Limit

323 mm (12.7 in.)

A WARNING

For safety, use only the standard chain. It is an endless type and should not be cut for installation; have it installed by an authorized Kawasaki dealer.

- Rotate the rear wheel to inspect the drive chain for damaged rollers, and loose pins and links.
- Also inspect the sprockets for unevenly or excessively worn teeth, and damaged teeth.

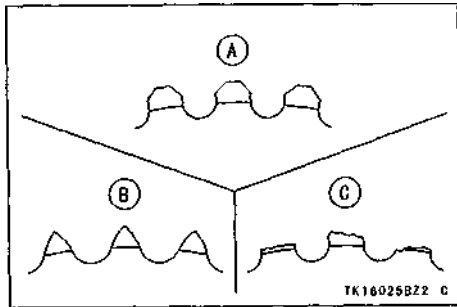

- A. Good Teeth
B. Worn Teeth
C. Damaged Teeth

- if there is any irregularity, have the drive chain and/or the sprockets replaced by an authorized Kawasaki dealer.

NOTE

O Sprocket wear is exaggerated for illustration. See Service Manual for wear limits.

NOTE

O When installing the chain cover, insert the chain cover to the groove, and tighten the bolts.

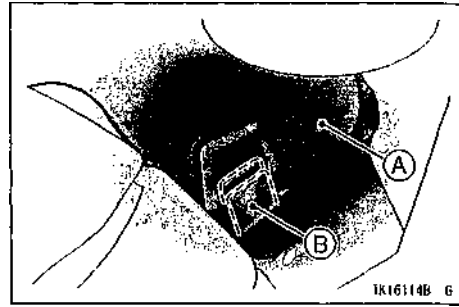

- A. Chain Cover
B. Groove

Lubrication

Lubrication is also necessary after riding through rain or on wet roads, or

any time that the chain appears dry. A heavy oil such as SAE 90 is preferred to a lighter oil because it will stay on the chain longer and provide better lubrication.

- Apply oil to the sides of the rollers so that it will penetrate to the rollers and bushings. Apply oil to the O-rings so that the O-rings will be coated with oil. Wipe off any excess oil.

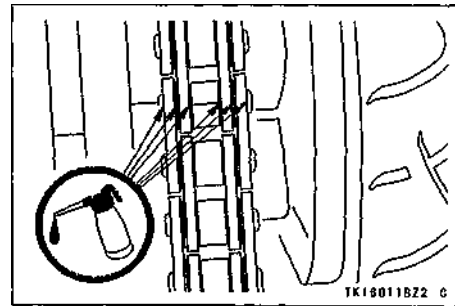

- If the chain is especially dirty, clean it using diesel oil or kerosine and then apply oil as mentioned above.

Brakes

Brake Wear Inspection

Inspect the brakes for wear. For each front and rear disc brake caliper, if the thickness of either pad is less than 1 mm (0.04 in.), replace both pads in the caliper as a set. Pad replacement should be done by an authorized Kawasaki dealer.

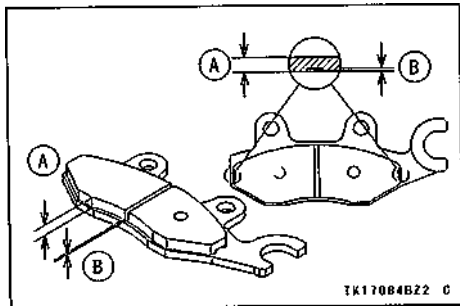

A. Lining Thickness
B. 1 mm (0.04 in.)

Disc Brake Fluid -

In accordance with the Periodic Maintenance Chart, inspect the brake fluid level in both the front and rear brake fluid reservoirs and change the brake fluid. The brake fluid should also be changed if it becomes contaminated with dirt or water.

Fluid Requirement

Use heavy-duty brake fluid only from a container marked DOT4.

CAUTION

Do not spill brake fluid onto any painted surface.

Do not use fluid from a container that has been left open or that has been unsealed for a long time.

Check for fluid leakage around the fittings.

Check brake hose for damage.

Fluid Level Inspection

- e The brake fluid level in the front brake fluid reservoir must be kept above the line (lower level line) next to the gauge and that in the rear brake fluid reservoir (located near the rear fender) must be kept between the upper and lower level lines (reservoirs held horizontal).

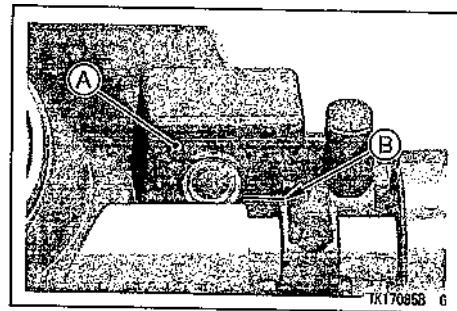

A. Front Brake Fluid Reservoir
B. Lower Level Line

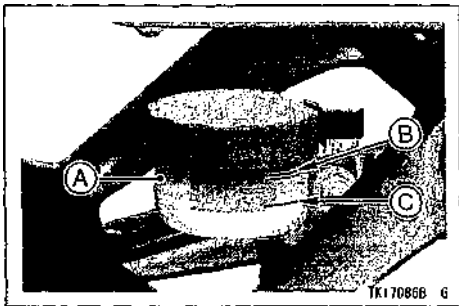

A. Rear Brake Fluid Reservoir
 B. Upper Level Line
 C. Lower Level Line

- If the fluid level in either reservoir is lower than the lower level line, check for fluid leaks in the brake lines, and fill the reservoir to the upper level line. Inside the front brake fluid reservoir is a stepped line showing the upper level line.

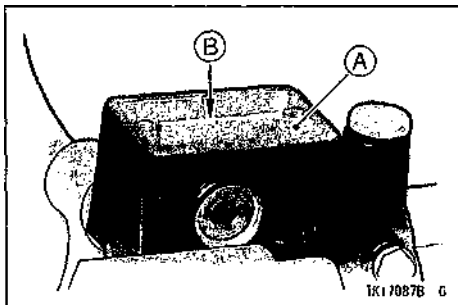

A. Front Brake Fluid Reservoir
 B. Upper Level Line

⚠ WARNING

Do not mix two brands of brake fluid. Change the brake fluid in the brake line completely if the brake fluid must be refilled but the type and brand of the brake fluid that is already in the reservoir are unidentified.

NOTE

O First, tighten until slight resistance is felt indicating that the cap is seated on the reservoir body; then, tighten the cap an additional 1/6 turn while holding the brake fluid reservoir body.

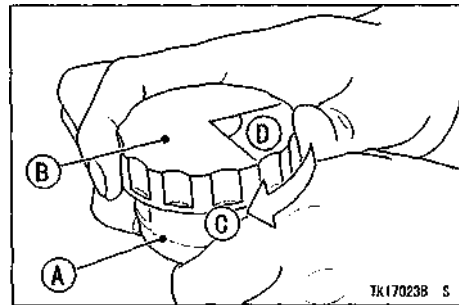

A. Reservoir
 B. Cap
 C. Clockwise
 D. 1/6 turn

Fluid Change

Have the brake fluid changed by an authorized Kawasaki dealer.

Front and Rear Brakes -

Disc and disc pad wear is automatically compensated for and has no effect on the brake lever or pedal action. So there are no parts that require adjustment on the front brakes and rear brakes.

WARNING ^

If the brake lever or pedal feels mushy when it is applied, there might be air in the brake lines or the brake may be defective. Since it is dangerous to operate the motorcycle under such conditions, have the brake checked immediately by an authorized Kawasaki dealer.

Brake Light Switches

When either the front or rear brake is applied, the brake light goes on. The front brake light switch requires no adjustment, but the rear brake light switch should be adjusted in accordance with the Periodic Maintenance Chart.

Inspection

- o Turn the ignition key to "ON".
- o The brake light should go on when the front brake is applied,
- o If it does not, ask your authorized Kawasaki dealer to inspect the front brake light switch.

- o Check the operation of the rear brake light switch by depressing the brake pedal. The brake light should go on after the proper pedal travel.

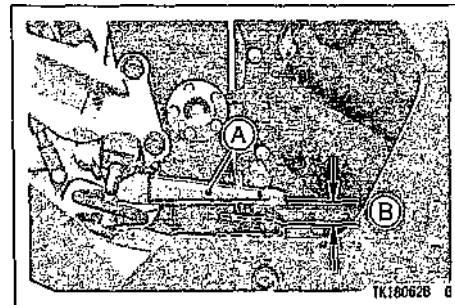

- A. Brake Pedal
- B. Pedal Travel

- e If it does not, adjust the rear brake light switch.

Brake Pedal Travel

10 mm (0.4 in.)

Adjustment

- e To adjust the rear brake light switch, move the switch up or down by turning the switch body.

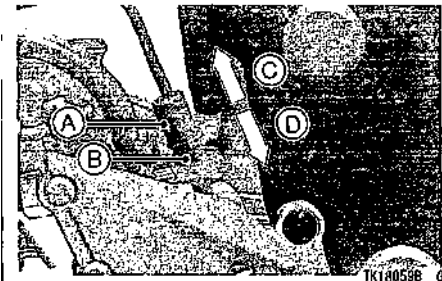

- A. Rear Brake Light Switch
- B. Adjusting Nut
- C. Lights sooner
- D. Lights later

CAUTION

To avoid damaging the electrical connections inside the switch, be sure that the switch body does not turn during adjustment.

Front Fork

The front fork operation and oil leakage should be checked in accordance with the Periodic Maintenance Chart.

Front Fork Inspection

- e Holding the brake lever, pump the front fork up and down by several times for inspection of smooth stroke.
- o Visually inspect the front fork for oil leakage, scoring or scratches on the outer surface of the inner tube.

- o If any doubt about the front fork, it should be done by an authorized Kawasaki dealer.

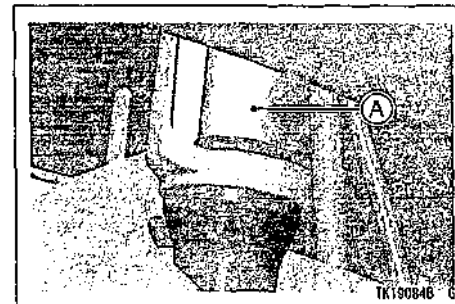

A. Inner Tube

Rear Shock Absorbers

The rear shock absorber operation and oil leakage should be checked in accordance with the Periodic Maintenance Chart.

Spring Preload Adjustment

The spring preload adjuster on the rear shock absorber has 5 positions.

- Remove the chain cover. Refer to the Drive Chain section of this chapter.

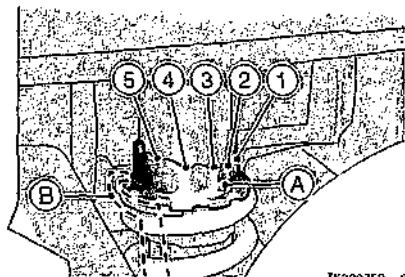

- A. Spring Preload Adjuster
B. Wrench

- In accordance with the following table, turn the preload adjuster with the wrench from the tool kit.

NOTE

O When turning the preload adjuster with the wrench, remove the chain cover.

Position	1	2	3	4	5
Spring Action	Stronger———•				

The standard setting position for an average-build rider of 68 kg (150 lb) with no passenger and no accessories is No. 2.

- Install the chain cover. Refer to the Drive Chain section of this chapter.

WARNING

This unit contains high pressure nitrogen gas. Mishandling can cause explosion.

Read Service Manual for instructions.

Do not incinerate, puncture or open.

Wheels

Tubeless tires are installed on the wheels of this motorcycle. The indications of TUBELESS on the tire side wall and the rim show that the tire and rim are specially designed for tubeless use.

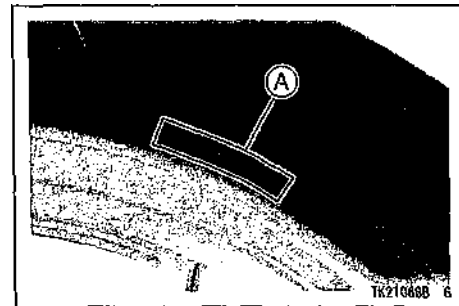

A. TUBELESS Mark

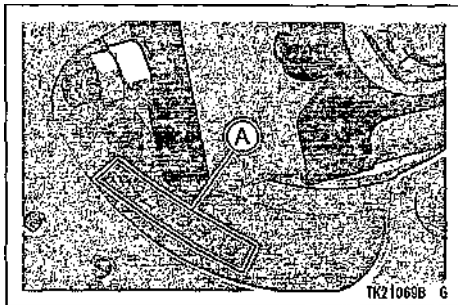

A. TUBELESS Mark

The tire and rim form a leakproof unit by making airtight contacts at the tire chamfers and the rim flanges instead of using an inner tube.

WARNING

The tires, rims, and air valves on this motorcycle are designed only for tubeless type wheels. The recommended standard tires, rims, and air valves must be used for replacement.

Do not install tube-type tires on tubeless rims. The beads may not seat properly on the rim causing tire deflation.

Do not install a tube inside a tubeless tire. Excessive heat build-up may damage the tube causing tire deflation.

Tires -

Payload and Tire Pressure

Failure to maintain proper inflation pressures or observe payload limits for

your tires may adversely affect handling and performance of your motorcycle and can result in loss of control. The maximum recommended load in addition to vehicle weight is 170 kg (375 lb), including rider, passenger, baggage, and accessories,

- o Remove the air valve cap.
- o Check the tire pressure often, using an accurate gauge.
- © Make sure to install the air valve cap securely.

NOTE

- o *Measure the tire pressure when the tires are cold (that is, when the motorcycle has not been ridden more than a mile during the past 3 hours).*
- o *Tire pressure is affected by changes in ambient temperature and altitude, and so the tire pressure should be*

checked and adjusted when your riding involves wide variations in temperature or altitude.

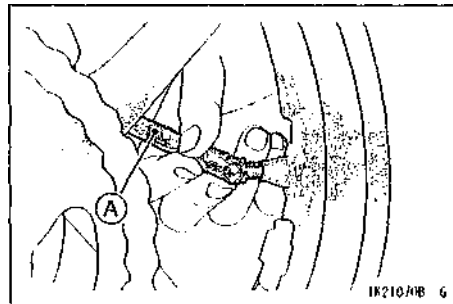

A. Tire Pressure Gauge

Tire Air Pressure (when cold)

Front	200 kPa (2.00 kgf/cm ² , 28 psi)
Rear	225 kPa (2.25 kgf/cm ² , 32 psi)

Tire Wear, Damage

As the tire tread wears down, the tire becomes more susceptible to puncture and failure. An accepted estimate is that 90% of all tire failures occur during the last 10% of tread life (90 % worn). So it is false economy and unsafe to use the tires until they are bald.

- In accordance with the Periodic Maintenance Chart, measure the depth of the tread with a depth gauge, and replace any tire that has worn down to the minimum allowable tread depth.

Minimum Tread Depth

Front		1 mm (0.04 in.)
Rear	Under 130 km/h (80 mph)	2 mm (0.08 in.)
	Over 130 km/h (80 mph)	3 mm (0.12 in.)

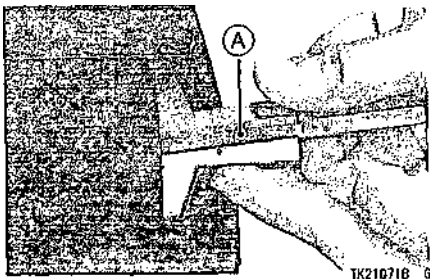

A. Tire Depth Gauge

- © Visually inspect the tire for cracks and cuts, replacing the tire in case of bad damage. Swelling or high spots indicate internal damage, requiring tire replacement.
- © Remove any imbedded stones or other foreign particles from the tread.

NOTE

- Most countries may have their own regulations requiring a minimum tire tread depth; be sure to follow them.
- Have the wheel balance inspected whenever a new tire is installed.

NOTE**WARNING**

To ensure safe handling and stability, use only the recommended standard tires for replacement, inflated to the standard pressure.

Tires that have been punctured and repaired do not have the same capabilities as undamaged tires. Do not exceed 100 km/h (60 mph) within 24 hours after repair, and 180 km/h (110 mph) at any time after that.

NOTE

- When operating on public roadways, keep maximum speed under traffic law limits.

Standard Tire (Tubeless)

Front	Size: 110/70-17 M/C (54S) • IRC "RX-OIF" TL Size: 110/70-17 M/C (54H) • BRIDGESTONE "BT-45F" TL • DUNLOP "GT501FG" TL
Rear	Size: 130/70-17 M/C (62S) • IRC "RX-OIR" TL Size: 130/70-17 M/C (62H) • BRIDGESTONE "BT-45R" TL • DUNLOP "GT501FR" TL

WARNING

Use the same manufacturer's tires on both front and rear wheels.

WARNING

New tires are slippery and may cause loss of control and injury. A break-in period of 160 km (100 miles) is necessary to establish normal tire traction. During break-in, avoid sudden and maximum braking and acceleration, and hard cornering.

Battery

The battery installed in this motorcycle is a sealed type, so it is not necessary to check the battery electrolyte level or add distilled water.

The sealing strip should not be pulled off once the specified electrolyte has been installed in the battery for initial service.

However, in order to maximize battery life and ensure that it will provide the power needed to start the motorcycle you must properly maintain the battery's charge. When used regularly, the charging system in the motorcycle helps keep the battery fully charged. If your motorcycle is only used occasionally or for short periods of time, the battery is more likely to discharge.

Due to their internal composition, batteries continually self discharge. The discharge rate depends on the type of battery and ambient temperature. As temperatures rise, so does the discharge rate. Every 15°C (27°F) doubles the rate.

Electrical accessories, such as digital clocks and computer memory, also draw current from the battery even when the key is switched off. Combine such "key-off" draws with hot temperature, and a battery can go from fully charged to completely discharged in a matter of days.

Self-discharge		
Temperature	Approx. Number of Days From 100% Charged to 100% discharged	
	Lead -Antimony	Lead -Calcium
	Battery	Battery
40°C (104°F)	100 Days	300 Days
25°C (77°F)	200 Days	600 Days
0°C (32°F)	550 Days	950 Days

Current Drain		
Discharging Ampere	Days from 100% charged to 50% Discharged	Days from 100% charged to 100% Discharged
	7 mA	60 Days
10 mA	42 Days	83 Days
15 mA	28 Days	56 Days
20 mA	21 Days	42 Days
30 mA	14 Days	28 Days

In extremely cold weather the fluid in an inadequately charged battery can easily freeze, which can crack the case and buckle the plates. A fully charged battery can withstand sub-freezing temperatures with no damage.

Battery Sulfation

A common cause of battery failure is sulfation.

Sulfation occurs when the battery is left in a discharged condition for an extended time. Sulfate is a normal by product of the chemical reactions within a battery. But when continuous discharge allows the sulfate to crystallize in the cells, the battery plates become permanently damaged and will not hold a charge. Battery failure due to sulfation is not warrantable.

Battery Maintenance

It is the owner's responsibility to keep the battery fully charged. Failure to do so can lead to battery failure and leave you stranded.

If you are riding your vehicle infrequently, inspect the battery voltage weekly using a voltmeter. If it drops below 12.8 volts, the battery should be charged using an appropriate charger (check with your Kawasaki dealer).

If you will not be using the motorcycle for longer than two weeks, the battery should be charged using an appropriate charger. Do not use an automotive-type quick charger that may overcharge the battery and damage it.

Kawasaki-recommended chargers are:

OptiMate 111

Yuasa 1.5 Amp Automatic charger

Battery Mate 150-9

If the above chargers are not available, use equivalent one.

For more details, ask your Kawasaki dealer.

Battery Charging

- Remove the battery from the motorcycle (see Battery Removal).
- Attach the leads from the charger and charge the battery at a rate that is 1/10th of the battery capacity. For

example, the charging rate for a 10 Ah battery would be 1.0 ampere.

- The charger will keep the battery fully charged until you are ready to re-install the battery in the motorcycle (see Battery Installation).

CAUTION

Never remove the sealing strip, or the battery can be damaged. Do not install a conventional battery in this motorcycle, or the electrical system cannot work properly.

NOTE

If you charge the sealed battery, never fail to observe the instructions shown in the label on the battery.

Battery Removal

- Remove the bolts and the left and right side covers.
- Remove the rider's seat.
- Remove the ECU.

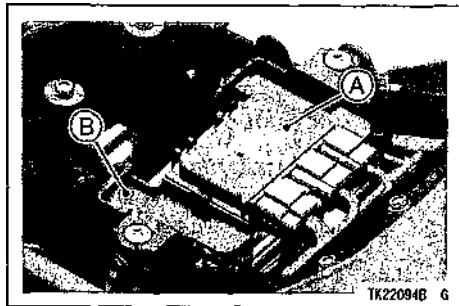

- A. ECU
- B. Battery Cover

- Unscrew the cover screw and pull up the battery cover.

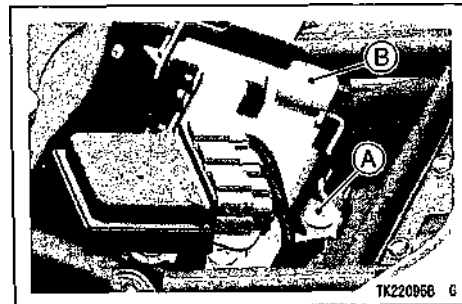

- A. Cover Screw
- B. Battery Cover

- Disconnect the wires from the battery, first from the (-) terminal and then the (+) terminal.

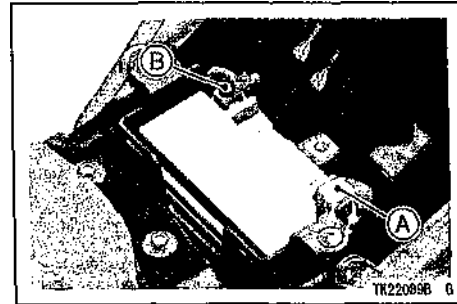

- A. (+) Terminal
- B. (-) Terminal

- Take the battery out of the case.
- Clean the battery using a solution of baking soda and water. Be sure that the wire connections are clean.

Battery Installation

- Place the battery in the battery case.
- Connect the capped wire to the (+) terminal, and then connect the black wire to the (-) terminal.

NOTE

○ Install the battery in the reverse order of the Battery Removal.

CAUTION

Installing the (-) wire to the (+) terminal of the battery or the (+) wire to the (-) terminal of the battery can seriously damage the electrical system.

- Put a light coat of grease on the terminals to prevent corrosion.
- Cover the (+) terminal with its protective cap.
- Reinstall the parts removed .

NOTE

○ When installing the battery cover, insert tabs of the battery cover into

slots of the battery case and tighten the screw.

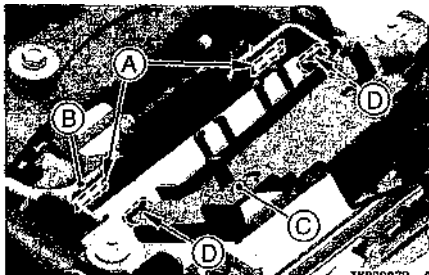

- A. Slots
- B. Battery Case
- C. Battery Cover
- D. Tabs

Headlight Beam*Horizontal Adjustment*

The headlight beam is adjustable horizontally. If not properly adjusted horizontally, the beam will point to one side rather than straight ahead.

- Turn the horizontal adjuster clockwise or counterclockwise until the beam points straight ahead.

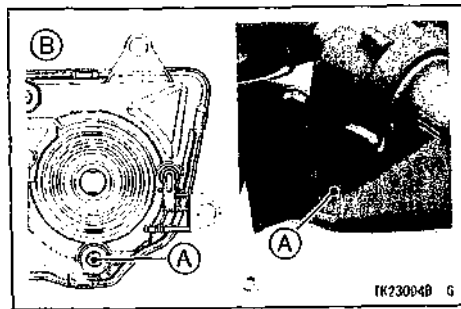

- A. Horizontal Adjuster
- B. View From Back Side

Vertical Adjustment

The headlight beam is adjustable vertically. If adjusted too low, neither low nor high beam will illuminate the road far enough ahead. If adjusted too high, the high beam will fail to illuminate the road close ahead, and the low beam will blind oncoming drivers.

- Turn the vertical adjuster clockwise or counterclockwise to adjust its vertical angle.

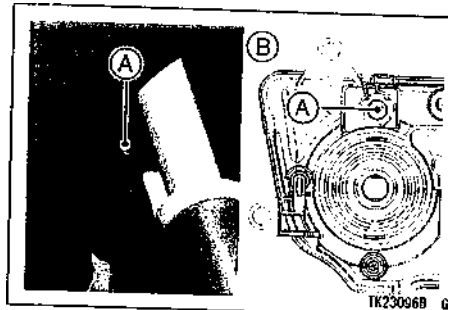

A. Vertical Adjuster
B. View From Back Side

CAUTION

When handling the quartz-halogen bulbs, never touch the glass portion with bare hands. Always use a clean cloth. Oil contamination from hands or dirty rags can reduce bulb life or cause the bulb to explode.

NOTE

i On high beam, the brightest point should be slightly below horizontal with the motorcycle on its wheels and the rider seated. Adjust the headlight to the proper angle according to local regulations.

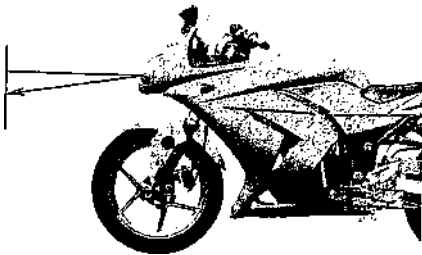

TK23097B G

Fuses

Fuses are arranged in the fuse box located under the rider's seat. The main fuse is mounted on the starter relay located under the seat. If a fuse fails during operation, inspect the electrical system to determine the cause, and then replace it with a new fuse of proper amperage.

- Remove the left and right side covers by removing the bolt.
- Remove the rider's seat.

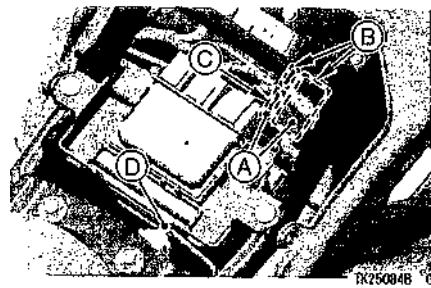

A. Fuse Box
B. Fuses
C. Spare Parts
D. Main Fuse

WARNING

Do not use any substitute for the standard fuse.

Replace the blown fuse with a new one of the correct capacity, as specified on the fuse box and main fuse.

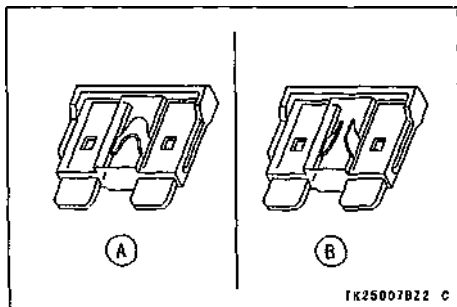

A. Normal
B. Failed

Cleaning Your Motorcycle*General Precautions*

Frequent and proper care of your Kawasaki motorcycle will enhance its appearance, optimize overall performance, and extend its useful life. Covering your motorcycle with a high quality, breathable motorcycle cover will help protect its finish from harmful UV rays, pollutants, and reduce the amount of dust reaching its surfaces.

- Be sure the engine and exhaust are cool before washing.
- Avoid applying degreaser to seals, brake pads, and tires.
- Always use non-abrasive wax and cleaner/polisher.
- Avoid all harsh chemicals, solvents, detergents, and household cleaning products such as ammonia-based window cleaners.

- Gasoline, brake fluid, and coolant will damage the finish of painted and plastic surfaces: wash them off immediately.
- Avoid wire brushes, steel wool, and all other abrasive pads or brushes.
- Use care when washing the windshield, headlight cover, and other plastic parts as they can easily be scratched.
- Avoid using pressure washers; water can penetrate seals and electrical components and damage your motorcycle.
- Avoid spraying water in delicate areas such as in air intakes, throttle body, brake components, electrical components, muffler outlets, and fuel tank openings.

Washing Your Motorcycle

- Rinse your bike with cold water from a garden hose to remove any loose dirt.
- Mix a mild neutral detergent (designed for motorcycles or automobiles) and water in bucket. Use a soft cloth or sponge to wash your motorcycle. If needed, use a mild degreaser to remove any oil or grease build up.
- After washing, rinse your motorcycle thoroughly with clean water to remove any residue (residue from the detergent can damage parts of your motorcycle).
- Use a soft cloth to dry your motorcycle. As you dry, inspect your motorcycle for chips and scratches. Do not let the water air dry as this can damage the painted surfaces.

- After cleaning your motorcycle, check the rubber boot covering the shift pedal ball joint for correct installation. Be sure the sealing lip of the rubber boot fits into the groove of the ball joint.

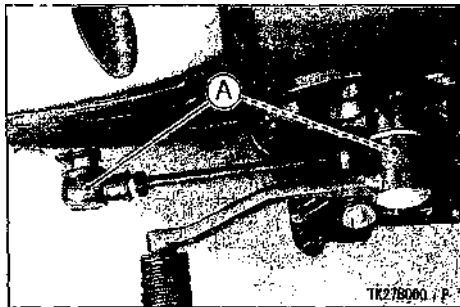

A. Boots

- If the boot is damaged, replace it with a new one. If the boot is not positioned in the groove correctly, replace it in the correct position.

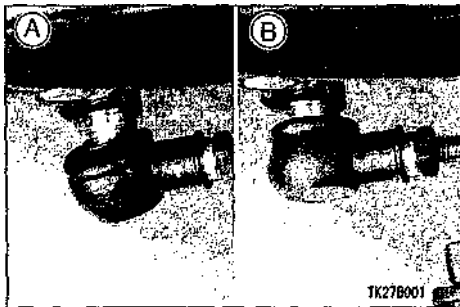

A. Wrongly set lip not in the correct position
 B. Lip set correctly in the groove

- Start the engine and let it idle for several minutes. The heat from the engine will help dry moist areas.
- Carefully ride your motorcycle at a slow speed and apply the brakes

several times. This helps dry the brakes and restores them to normal operating performance.

- Lubricate the drive chain to prevent rusting.

NOTE

○ After riding in an area where the roads are salted or near the ocean, immediately wash your motorcycle with cold water. Do not use warm water as it accelerates the chemical reaction of the salt. After drying, apply a corrosion protection spray on all metal and chrome surfaces to prevent corrosion.

○ Condensation may form on the inside of the headlight lens after riding in the rain or washing the motorcycle. To remove the moisture, start the engine and turn on the headlight. Gradually the condensation on the inside of the lens will clear off.

Painted Surfaces

After washing your motorcycle, coat painted surfaces, both metal and plastic, with a commercially available motorcycle/automotive wax. Wax should be applied once every three months or as conditions require. Avoid surfaces with "satin" or "flat" finishes. Always use non-abrasive products and apply them according to the instructions on the container.

Windshield and Other Plastic Parts

After washing use a soft cloth to gently dry plastic parts. When dry, treat the windshield, headlight lens, and other non-painted plastic parts with an approved plastic cleaner/polisher product.

CAUTION

Plastic parts may deteriorate and break if they come in contact with chemical substances or household cleaning products such as gasoline, brake fluid, window cleaners, thread-locking agents, or other harsh chemicals. If a plastic part comes in contact with any harsh chemical substance, wash it off immediately with water and a mild neutral detergent, and then inspect for damage. Avoid using abrasive pads or brushes to clean plastic parts, as they will damage the part's finish.

Chrome and Aluminum

Chrome and uncoated aluminum parts can be treated with a chrome/aluminum polish. Coated aluminum

should be washed with a mild neutral detergent and finished with a spray polish. Aluminum wheels, both painted and unpainted can be cleaned with special non-acid based wheel spray cleaners.

Leather, Vinyl, and Rubber

If your motorcycle has leather accessories, special care must be taken. Use a leather cleaner/treatment to clean and care for leather accessories. Washing leather parts with detergent and water will damage them, shortening their life.

Vinyl parts should be washed with the rest of the motorcycle, then treated with a vinyl treatment.

The sidewalls of tires and other rubber components should be treated with a rubber protectant to help prolong their useful life.

WARNING

Special care must be taken not to get any rubber protectant on the tire's tread surface when treating tires. This may decrease the tire's ability to maintain contact with the road surface causing the rider to lose control.

STORAGE

Preparation for Storage:

- Clean the entire vehicle thoroughly.
- Run the engine for about five minutes to warm the oil, shut it off, and drain the engine oil.

WARNING

Motorcycle oil is a toxic substance. Dispose of used oil properly. Contact your local authorities for approved disposal methods or possible recycling.

- « Put in fresh engine oil.
- Empty the fuel from the fuel tank by the pump or siphon.

WARNING

Gasoline is extremely flammable and can be explosive under certain conditions. Turn the ignition key to "OFF". Do not smoke. Make sure the area is well ventilated and free from any source of flame or sparks; this includes any appliance with a pilot light.

Gasoline is a toxic substance. Dispose of gasoline properly. Contact your local authorities for approved disposal methods.

- Empty the fuel system by running the engine at idle speed until the engine stalls. (If left in for a long time, the fuel will break down and could clog the fuel system.)
- Reduce tire pressure by about 20%.
- Set the motorcycle on a box or stand so that both wheels are raised off the ground. (If this cannot be done, put boards under the front and rear wheels to keep dampness away from the tire rubber.)
- Spray oil on all unpainted metal surfaces to prevent rusting. Avoid getting oil on rubber parts or in the brakes.
- Lubricate the drive chain and all the cables.
- Remove the battery, and store it where it will not be exposed to direct sunlight, moisture, or freezing temperatures. During storage it should be given a slow charge (one ampere or less) about once a month. Keep the battery well charged especially during cold weather.
- Tie plastic bags over the mufflers to prevent moisture from entering.

- Put a cover over the motorcycle to keep dust and dirt from collecting on it

Preparation after Storage:

- Remove the plastic bags from the mufflers.
- Install the battery in the motorcycle and charge the battery if necessary.
- Fill the fuel tank with fuel.
- Check all the points listed in the Daily Safety Checks section.
- Lubricate the pivots, bolts, and nuts.

ENVIRONMENTAL PROTECTION

To protect our environment, properly discard used batteries, tires, engine oil, or other vehicle components that you might dispose of in the future. Consult your authorized Kawasaki dealer or local environmental waste agency for their proper disposal procedure.

LOCATION OF LABELS

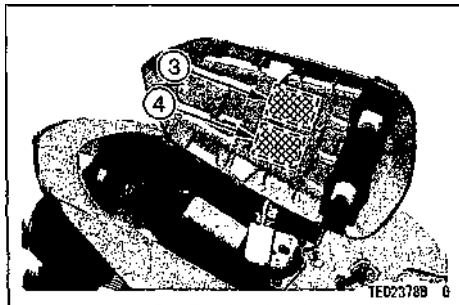
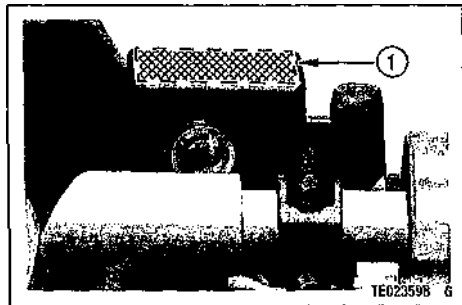

1. Brake Fluid (Front)
 2. Brake Fluid (Rear)
 3. Daily Safety Checks (French)
 4. Daily Safety Checks (English)
- (For further information of label, refer to the "LABEL INFORMATION" chapter.)

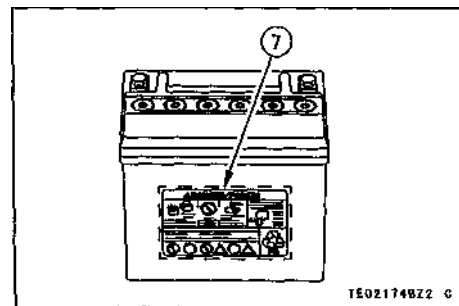
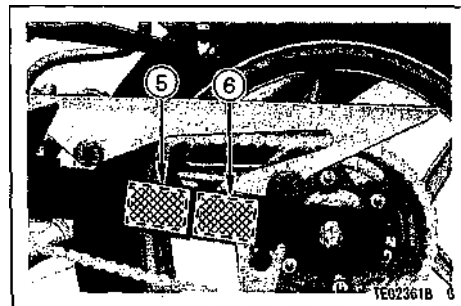
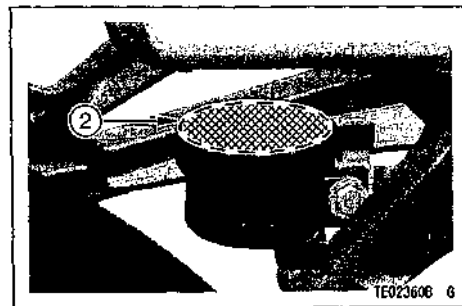

5. Tire and Load Data
6. Important Drive Chain Information
7. Battery Poison/Danger

(For further information of label, refer to the "LABEL INFORMATION" chapter.)

LABEL INFORMATION

(D)

USE ONLY DOT3 OR 4 BRAKE
FLUID FROM A SEALED CONTAINER.
CLEAN FILLER CAP
BEFORE REMOVING.

WARNING

UTILISER DU LIQUIDE
DE FREIN DOT3 OU 4.

TE0381BBN9 C

(2)

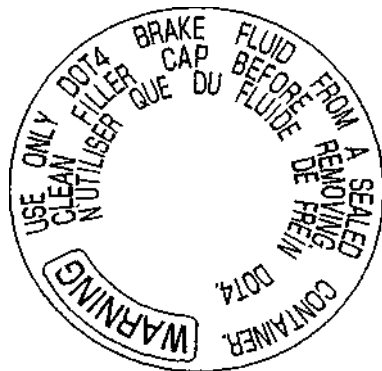

(3)

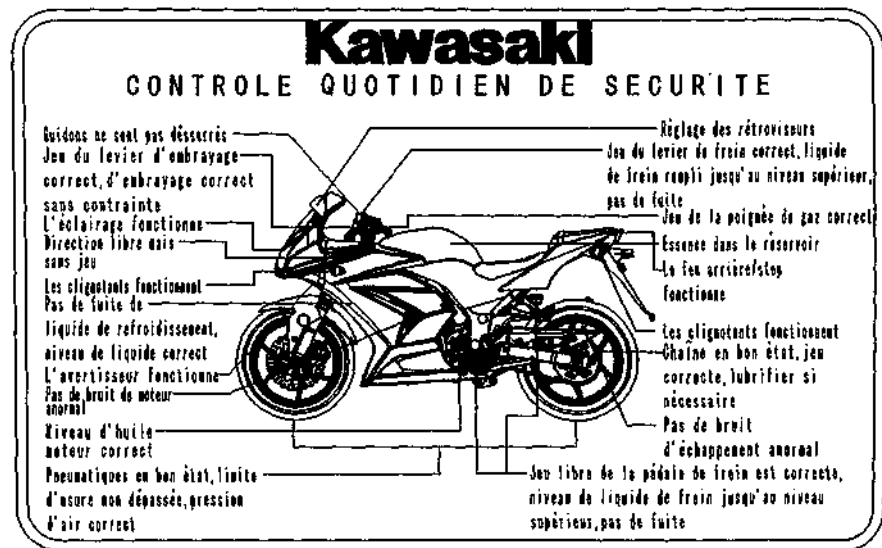

TE037598Z9 C

(4)

Kawasaki

DAILY SAFETY CHECKS

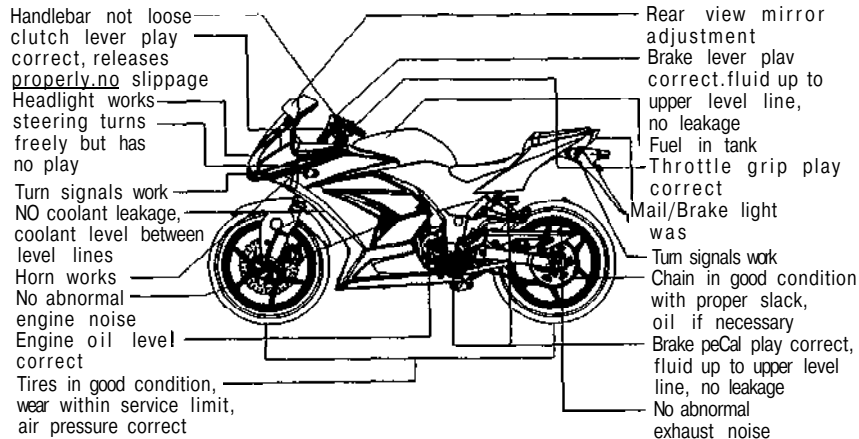

TE03751B 5

(5)

TIRE AND LOAD DATA

The stability and handling characteristics of this motorcycle could become unsafe by the use of improper tire inflation pressures, worn tires, unsuitable replacement tires, or overloading. When tire tread wears down to the limit, replace the tire with only the standard tire. Maintain the inflation pressure specified.

	Air Pressure (Cold)	Size & Make Type (Tubeless Tire)	Minimum Tread Depth
Front	200 kPa (2.00 bar/29.0 psi) No to 170 kg Load (375 lbs)	110/70-17M/C 54S EX-01E TL 110/70-17M/C 54H EX-01E TL	1 mm (0.04 in)
Rear	225 kPa (2.25 bar/32.7 psi)	130/70-17M/C 62S EX-01H TL 130/70-17M/C 62H EX-01H TL	No to 130 km/h (80 MPH) 2 mm (0.08 in) Over 130 km/h (80 MPH) 3 mm (0.12 in)

TE03813BN8 C

(6)

IMPORTANT DRIVE CHAIN INFORMATION

To prevent an accident and/or damage to the motorcycle, the drive chain must be properly maintained. It should be lubricated every 800km (400mi) and adjusted as often as necessary to keep chain slack at about 20~30mm (0.8~1.2in) measured midway between sprockets on the lower chain run with the motorcycle on the side stand. The standard chain is an Enuma EX520SR-02 with estimated service life of 15000~45000km (9400~28000mi), depending on the severity of use and the frequency of lubrication and adjustment. For safety, replace the chain with only the standard chain any time it wears to over 323mm (12.7in), measured over a 20-link portion pulled straight with 98N (10kgf, 20lbf) of tension. See the Owner's Manual for chain information.

TE03753BN8 C

(7)

DANGER/POISON



SHIELD EYES

EXPLOSIVE

GASES CAN CAUSE
BLINDNESS OR INJURY



NO

- SPARKS
- FLAMES
- SMOKING



SULFURIC ACID

CAN CAUSE
BLINDNESS OR
SEVERE BURNS

**FLUSH EYES
IMMEDIATELY
WITH WATER**

**GET
MEDICAL**



KEEP OUT OF REACH OF CHILDREN

IN U.S.A.,

YUASA INC.

SERVICED BY

READING, PA. 19612

