

# MOTOR AM6

---

Workshop manual



### INTRODUCTION

NOTES FOR EASY CONSULTATION	6
GENERAL WORK PROCEDURES	7
RECOMMENDATIONS	8
SPARK PLUGS	10

### ENGINE RIEJU

EQUIPMENT KIT	14
LUBRICANTS	14
ENGINE DISASSEMBLY	15
MAINTENANCE	22
ENGINE ASSEMBLY	26
ENGINE SERVICING AND COMMISSIONING SCHEDULE	33
PARTS AND THEIR TORQUE WRENCH SETTINGS	34
EXPLODED VIEW OF THE ENGINE AM6 EURO 2	36



# *Introduction*



- All **checks, maintenance, repairs or replacements**, etc. on the vehicles manufactured by Magguti are to be performed by skilled and expert technical personnel with specific experience in state-of-the-art technology and full knowledge of the quickest and most rational procedures, technical characteristics, setting values and tightening torques, which may only be properly and exhaustively provided by the manufacturer.
- This set of **WORKSHOP MANUALS** concerning two-stroke engines provides **technicians of the sector** (Authorised Service Centres, etc.), the essential information for operating in accordance with the latest **good working practices** and **work safety regulations**.
- These publications provide all necessary information for routine procedures on all the **RIEJU**-motor vehicles equipped with two-stroke engines currently in production at the date of issue. The information provided deals with the motor vehicle **ENGINES**. Some basic technical information has been intentionally omitted as it is considered to be common knowledge.
- Additional information is available in the **SPARE PARTS CATALOGUES** of each model.
- **It is important** that before referring to the specific engine manual, the information given in this general section be carefully read as it provides all the essential hints and guidelines for best consulting the various topics and main technical subjects.

**Note:**

These manuals provide the necessary information and instructions for routine maintenance and servicing. This information has been given to us by the engine manufacturers. We therefore decline all responsibility for any error, omission or misrepresentation. **RIEJU** reserves the right to make any changes and modifications hereto it deems necessary without prior notice. For further information and details, please contact the **RIEJU, S.A.** Service Division.

## 1.1 MANUAL UPDATES

- **The updates** will be sent by us ( in a reasonable time). Every Cd-Rom you will receive, will supersede the one already in your hands.
- **The table of contents** will be duly updated in the event that new pages are inserted, which render the consultation of the manual difficult.
- **IMPORTANT!** The Workshop Manuals are to be considered as essential **tools** to be properly kept up-to-date so as to maintain their “ validity” over time.

## EDITING SYMBOLS



**CAUTION!** Recommendations and precautions regarding rider safety and motor vehicle integrity.



**WARNING!** Situations entailing the risk of personal injury to maintenance or repair mechanics, other workshop personnel or third parties, or damage to environment, vehicle or equipment.



**FIRE HAZARD**  
Indicates operations which may constitute a fire hazard.



**RISK OF EXPLOSION**  
Indicates operations which may constitute a risk of explosion.



**TOXIC FUMES**  
Indicates a possibility of intoxication or inflammation of the upper respiratory tract.



**MECHANICAL MAINTENANCE**  
Operations to be performed only by an expert mechanic.



**ELECTRICAL MAINTENANCE**  
Operations be performed only by an expert electrical / electronic technician.



**NO!**  
Operations to be absolutely avoided.



**ENGINE SERVICE MANUAL**  
Indicates information which may be obtained by referring to said manual.



**SPARE PARTS CATALOGUE**  
Indicates information which may be obtained by referring to said catalogue.





F	Figure
Pr Tr	Tightening torque
P	Page
Ap	Paragraph
S	Section
Es	Diagram
T	Table
Tr	Screw

**Note:**

*The letter Tr in the illustrations refers to retaining or adjusting screws. The number following this letter refers to the number of the same type of screw in the unit or component described and illustrated. Letters not followed by a number indicate a single screw. In case of different screws being referred to in the illustration, the letter Tr is followed by a number and a small letter, for instance: (Tr4a).*

*Unless otherwise specified, units and components are reassembled by proceeding in the reverse order of removal.*

**OPERATIONAL SYMBOLS**

L) Loctite



O) Oil lubrication



G) Greasing



### I.3 GENERAL WORK PROCEDURES

• The **advice, recommendations** and **warnings** given hereafter are aimed at ensuring maximum work safety as well as at considerably reducing the risk of accidents, personal injury, equipment damage and idle times. They should therefore be strictly adhered to.

#### ADVICE:

- Only use quality tools and equipment.
- Only use equipment conforming to EU Directives for lifting the vehicle.
- During operations, always keep tools and equipment at hand, possibly laying them out according to the sequence in which they are to be used. Absolutely avoid putting them on the vehicle itself, out-of-sight or in poorly accessible places.
- Always keep the work area clean and tidy.
- When tightening screws or nuts, start with the **larger diameter** or inner fasteners, and tighten them in progressive “**pulls**” in accordance to a “**criss-cross**” pattern.
- Preferably use open-end box wrenches by “**pulling**” and not “**pushing**”.
- Adjustable wrenches (F. 1) should only be used in case of emergency, i.e. when a properly sized wrench is not available. They should preferably not be used as the movable jaw tends to open thus risking damaging or not properly tightening the bolt to the correct torque. In any case, when using an adjustable wrench, take care to proceed as shown in Figure 1.
- Except for occasional customers, always make out and deliver to the customer a **work sheet** specifying the operations performed, with notes as to any future checks eventually required.

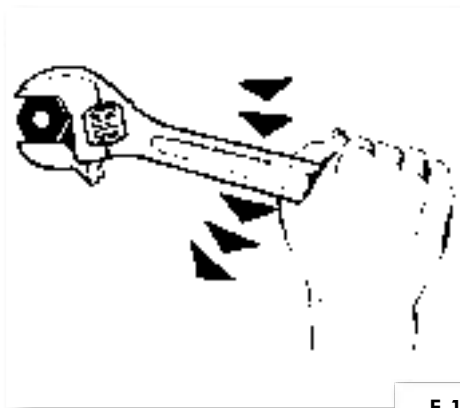

F-1





#### 1.4 WARNINGS

- **Before** carrying out any operation on the vehicle, wait for all parts to **cool** down.
- For operations requiring two mechanics, make sure that the various steps to be performed by each of them are clearly defined and coordinated beforehand.
- Make sure that each component has been properly fitted before proceeding with the next one.
- Lubricate all parts (where applicable) before reinstalling them.
- Gaskets, O-rings, circlips and split pins **must be replaced** at every refitting.
- The torque settings specified in the manuals refer to the “**final torque**”, which must be attained progressively by steps.
- Loosen and tighten aluminium alloy parts (covers) only after the engine has fully cooled down.
- Only use screwdrivers with sizes suitable to the screws to be loosened or tightened.
- **Work in a comfortable position and ensure that the vehicle is stable.**
- Never use a screwdriver as a lever or chisel.
- Never use pincers to loosen or tighten screws or nuts because, in addition to not providing a sufficient clamping force, they may also damage the screw head or nut hexagon.
- **Never tap the wrench with a hammer** or other similar tools to loosen or tighten screws and nuts (F. 2).
- **Never attempt to increase the lever arm** by fitting a tube into the wrench (F. 3).



F-2



F-3





**Never use open flames for any reason.**

**Never leave** open containers or containers not suitable for holding fuel in passageways, close to heat sources, etc



**Never use** petrol to clean the vehicle or the floor of the workshop. Always use low flash point solvents to clean the vehicle components.

**Never suck** from or blow into the fuel pipe.



**When welding**, make sure that there are no flammable liquids in the vicinity. Always remove the tank, even if completely empty, and disconnect the negative cable (-) from the battery.

**Never leave the engine running in closed or poorly ventilated areas.**



Before any servicing, make sure that the motorbike is perfectly stable. The front wheel should preferably be anchored to the equipment (A - F 4) integral with the lifting board.

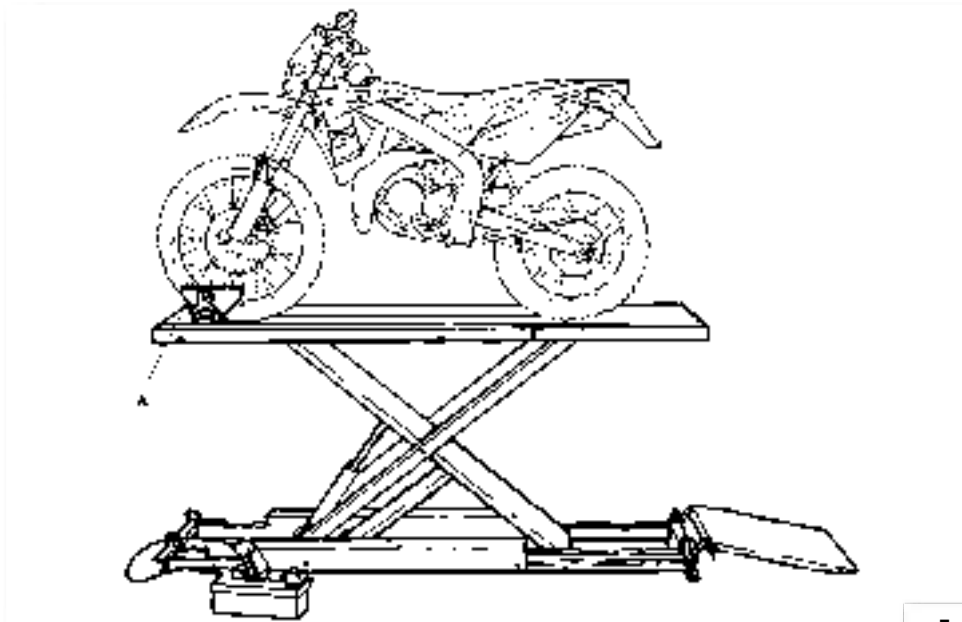

F-4



## I.5 SPARK PLUGS

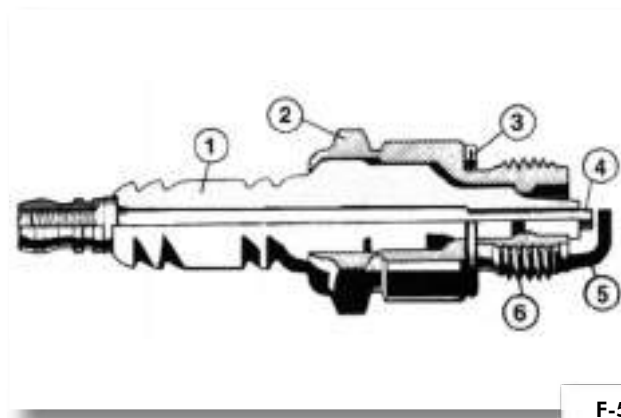

1. Insulator
2. Body
3. Gasket
4. Electrode
5. Earth electrode
6. Threads

F-5

### SPARK PLUG CHECK 1,000 km

- Remove the spark plug while the engine is hot ( taking utmost care to avoid scalding!).
- The carbon deposits and the colour of the insulator ( around the central electrode) provide good information as to the heat range of the spark plug and to carburetion, lubrication and general condition of the engine.
- A light brown colour of the insulator indicates that engine working conditions are generally correct.
- Sooty black deposits, that are dry ( to the touch) and opaque, are a sign that working temperature is too low, i.e. that the heat range of the spark plug is too high, mixture too rich or ignition defective.
- A whitish colour of the insulator is indicative of too lean a mixture or of too low a heat range of the spark plug (i.e. spark plug too “hot”).
- Check electrode gap (F.6) (even if the spark plug is new) by means of a calibrated thickness gauge. If necessary, adjust by acting only on the earth electrode.

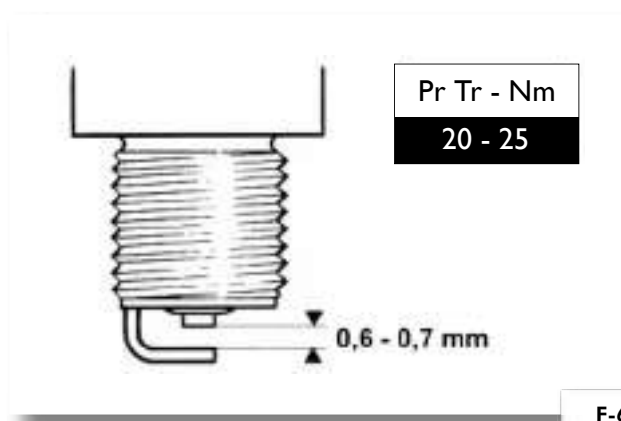

F-6

## SPARK PLUG MAINTENANCE

- Spark plug maintenance consists essentially of a periodical visual inspection. Remove the spark plug and check for proper condition and gap.
- Clean the electrodes and the insulator thoroughly by means of a wire brush.
- Remove any residual dirt with a strong jet of compressed air.
- Lubricate spark plug thread with engine oil or graphitised grease, and install it by hand until finger tight. Tighten to the specified torque with a spark plug wrench (see F.6).



**It is imperative that any spark plug exhibiting cracks on the insulator or corroded electrodes be replaced.**

## SPARK PLUG REPLACEMENT      5000 km

- Upon prescribed mileage being reached, always **replace the spark plug**. Use **RIEJU, S.A.** recommended spark plugs.
- When replacing exhausted spark plugs, visually inspect spark plug condition as described above to ascertain whether or not the engine is running properly.

## ENGINE REMOVAL

- For removal of the engine from the chassis, refer to the “**Chassis**” **Workshop Manual**, which lists all the operations required.

## ENGINE DISASSEMBLY



**The manufacturer declines all responsibility for damage of any kind caused by disassembly and reassembly of the engine and its parts if unsuitable tools are used.**

Use only **ORIGINAL RIEJU SPARE PARTS**.

# *Engine RIEJU*



## 2.1 EQUIPMENT KIT

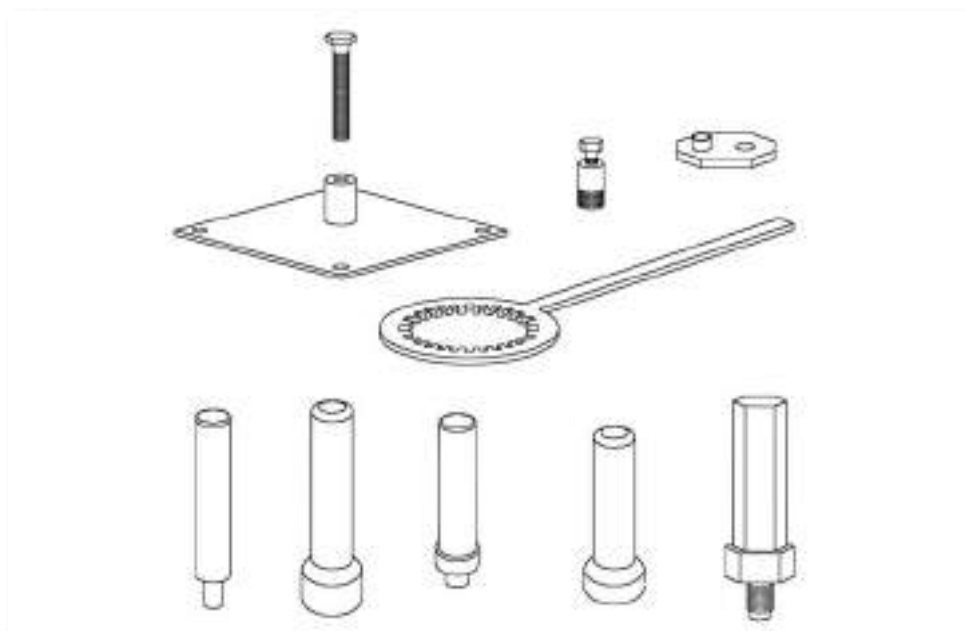

Code RIEJU 0/000.640.9999

## 2.2 LUBRICANTS

### LUBRICANTS TABLE

#### LUBRICANTS FOR TWO-STROKE ENGINE

- 1) Synthetic mix oil
- 2) Gearbox oil SAE 10W30, type SE

#### GENERAL PURPOSE LUBRICANTS

- 3) Grease for moving parts

### 2.3 DISASSEMBLY OF THE ENGINE

After removing the spark-plug and carburettor proceed as follows:

1) **DRAIN** the engine oil by removing the relevant drain bolt.

2) **UNSCREW** the coolant drainage screw (1-F1); remove the water pump cover by undoing the two fixing screws (2-F1). **Pay attention to the dowel bolts** (1-F2).

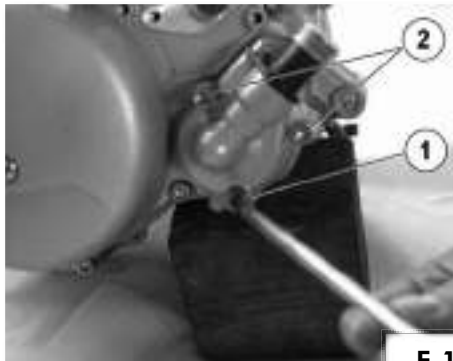

F-1



F-2

3) **UNDO** the fixing screws of the flywheel cover (left hand side) and remove it. Remove the starter motor (if fitted) by removing the two screws on the crankcase and the screw on the support strap.

4) Take the carburettor out of its seat; remove the intake union and the relative clutch “bridge”; remove the plate group (1 - F.3).

5) **REMOVE** the sprocket (1 - F.4) by removing the snap ring (2 - F.4); using ring pliers, remove the sprocket by hand and remove the other snap ring underneath the sprocket.



F-3



F-4





F-5

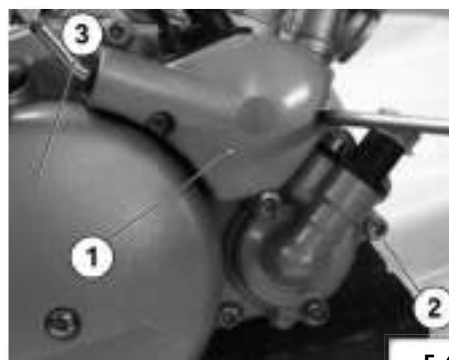

F-6

**6) REMOVE** the sliding stop screw for starting from clutch side (1 - F.5).

**7) REMOVE** the fixing screws of the plastic oil pump cap (1 - F.6). Undo the screws securing the oil pump to the cover; then remove the pump.



F-7



F-8

**8) REMOVE** the cover/crankcase fixing screws (of which one M6x55 (2 - F.6), that secure the water pump cover and the relative clutch cover to the crankcase); now remove the cover (3 - F.6) and its gasket.

**9) TAKE** the starter assembly OUT of its seat (only for versions with starter pedals), bearing in mind that the any shim washers must be put in the same position when the component is reassembled.



**CAUTION:** when disassembling this group, carefully check the position of the pieces so as to reassemble them correctly afterwards.

**10) UNDO** the screws compressing the clutch springs (1 - F.7); then remove the clutch plate (2 - F.7) and the entire set of discs (3 - F.7); remove the disc pusher, the ball and the clutch rod (1, 2, 3 - F.8), which are housed in the centre hole of the change shaft.



F-9

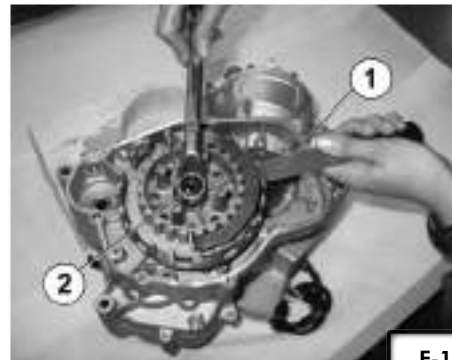

F-10



**11) DISENGAGE** the nut from its fixing tab (1 - F.9); using the appropriate wrench (1 - F.10), unscrew and remove the fixing nut (2 - F.10) of the clutch boss.

**12) REMOVE** the following pieces in this order: clutch boss (1-F.11), spacer (2-F.11), clutch gear (3-F.11), shim washer (1-F.12), tapered washer (2-F.12), paying attention to the direction in which they are assembled so as to reassemble them correctly afterwards.



F-11



F-12

**13) USING** the magneto flywheel locking wrench (1-F.13), lock the flywheel and slacken the retaining nut of the gear on the countershaft with the wrench (1-F.14).

**14) REMOVE** the gear on the countershaft (1 - F.14) and the key.



F-13



F-14





**15) UNSCREW** the nut (2-F.14) with a 19 mm wrench, whilst holding the flywheel in place with the special wrench; then remove the following parts in this order: drive pinion, countershaft drive gear, key, spacer bushing and O-ring.

**16) BLOCKING** the rotor of the magneto flywheel with the special locking wrench (1-F.15), unscrew the rotor retaining nut with a 15 mm wrench.

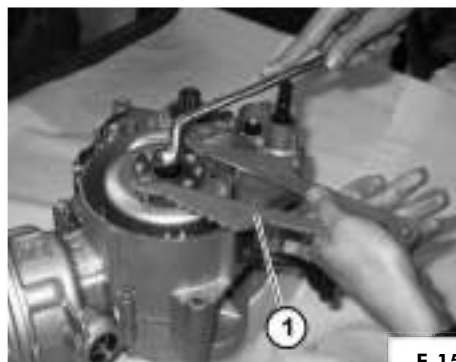

F-15



F-16

**17) REMOVE** the rotor of the magneto flywheel by means of the appropriate puller (1-F.16), which must be screwed into the threaded seat of the rotor; whilst holding the latter in place with a wrench, turn the centre screw.

**18) REMOVE** the stator by undoing the screws that secure it to the plate (1 - F.17).

**19) TAKE** the stator plate OUT of its seat by removing the 3 screws that secure it to the crankcase (2- F.17), and remove the key (3 - F.17).

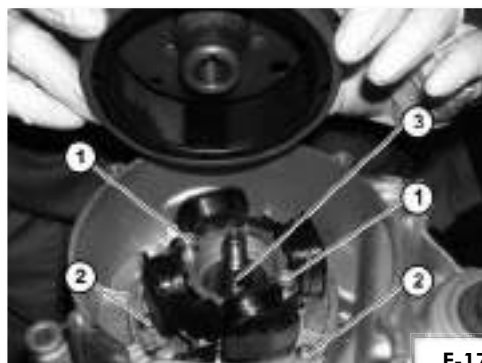

F-17

**20) DISASSEMBLING** the thermal section:

a) unscrew the 4 cylinder head holding nuts and remove the relevant washers; remove the head, its O-ring, the cylinder, the cylinder gasket and the four O-ring on the stud bolts.



F-18



F-19



**CAUTION:** before removing the circlips of the piston pin, put a clean cloth into the opening on the crankcase, to prevent the circlips dropping into the engine.

**21) REMOVE** the two circlips (F.18), remove the piston pin and, if you intend to use a 2-diameter plug, knock gently taking care to hold the piston on the opposite side in order to avoid damaging the connecting rod.

**22) REMOVE** the 13 screws joining the two crankcases (F.19) and take the clutch pin out of its seat.

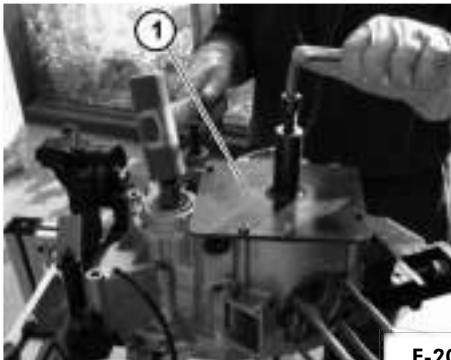

F-20



F-21

**23) SEPARATE** the 2 crankcases by gentling tapping the secondary shaft and shift shaft with a wooden mallet.

**IMPORTANT:** if you need to take the crankshaft out of its seat, use the special tool (1- F.20).

**24)** Once the crankcases have been separated, **CHECK** that the shim washers are on the shafts and not on the crankcase that has just been removed (F.21).





**25) PUT** the neutral signal pin in the position shown in the photo (F. 22), hence remove the shift shaft and its relevant lower shim washer (I - F. 23).



F-22



F-23

**26) PULL OUT** the fork guiding rod and remove the top fork (F.24); to take the fork out of its seat, remove the desmodronic shaft (F.25) and raise the gear on the secondary shaft carrying the forks.



F-24



F-25

**27) PUT** the following components **TOGETHER**: output shaft, secondary shaft and remaining fork and raise (F.26), paying attention to the shim washer under the secondary shaft.

**28) REMOVE** the equaliser countershaft: pull the connecting rod from the crankcase on clutch side; if necessary tap gently with a plastic or rubber mallet, paying attention not to damage the thread.

***N.B.:*** as far as the clutch crankcase side is concerned, the crankshaft and countershaft do not interfere with each other.

**29)** Bearings should only be **REMOVED** if they need to be replaced, i.e. they are worn or their service life has ended.



F-26

30) IF the oil pump needs to be replaced, proceed as follows (F.27):

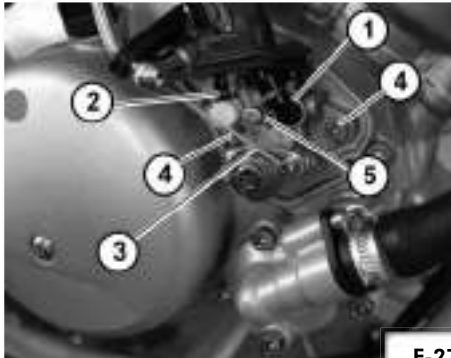

- a) Detach the oil pump supply pipe (1) and put a plug into it to prevent oil leaks.
- b) Detach the oil delivery pipe leading from the pump to the carburettor (2).
- c) Disconnect the control cable fastened to the pump's lever (3).
- d) Undo the pump fixing screws (4) and remove the pump.
- e) Fit the new pump in its seat and replace the O-ring.
- f) Plug the oil delivery pipe (2) into the new pump.
- g) Plug the oil supply pipe (1) into the pump.
- h) Take the purge screw and gasket off the pump (5) and let the oil containing air bubbles leak out. Wait until only oil is leaking out. Purging can thus be considered accomplished. You can now refit the screw in place.
- l) Reconnect the control cable (3) to the pump lever, making sure that the idle position of the throttle grip on the handlebar corresponds to the idle position of the lever; otherwise, make any necessary adjustments by means of the adjustment screw.



## 2.4 MAINTENANCE



### GENERAL WARNINGS

*Before reassembling the engine either totally or partially, thoroughly clean the parts by washing them with petrol, drying them with compressed air and making sure that they are sufficiently oiled and in perfect working order.*

*It is always advisable to replace the gaskets because old ones may be leaky. We recommend you always replace the engine oil seals: they may have been damaged during disassembly and this could adversely affect engine operation. Always use the special plugs to ensure correct assembly of the oil seals.*

#### A) Secondary gear shaft oil seal:

- Secondary gear shaft oil seal assembly plug.

#### B) Connecting rod oil seal:

- Connecting rod oil seal assembly plug, clutch side.
- Connecting rod oil seal assembly plug, flywheel side.

#### C) Clutch lever oil seal:

- Clutch lever oil seal assembly plug.

#### D) Shift shaft oil seal:

- Shift shaft oil seal assembly plug.

#### E) Water pump oil seal:

- Water pump oil seal assembly plug.



**Check carefully that the pieces are whole and arrange all the various groups of gears in such a way that assembly may be carried out correctly.**

## PREVENTIVE CARE

1) **WASH** the two crankcases and the bearings with petrol and blow them with compressed air, checking that the bearings run freely and noiselessly.

**CAUTION:** if it should be necessary to replace a bearing, the seat must be heated before installing the new bearing.

2) **MAKE SURE** the connecting rod is in perfect working order and check for faults, especially in the bearing seats. Make sure assembly on flywheel side has been properly accomplished. Using a comparator, check the eccentricity of the two connecting rod axle shafts. The maximum eccentricity value must not exceed 0.04 mm. On the contrary, centre accordingly. Make sure the connecting rod is perpendicular.

3) **MAKE SURE** the transmission is in perfect working order and fit the shim washers in the right positions. If you have replaced components, make sure that they are put in the same positions as the parts removed and that the end float does not exceed 0.1 mm. To obtain this condition, measure the distance of the shim washers on the crankcase and components, and fill any gaps with other shim washers, as shown in the photo (F.28).

4) **CHECK** the distance of the shim washer of the desmodronic shaft both on the crankcase and on the part, and fill any gaps with other shim washers, as shown in the photo (F.29). The end float must be less than 0.1 mm.

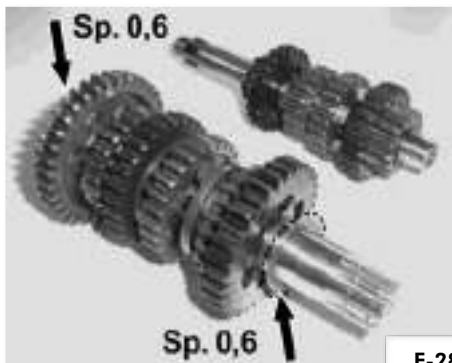

F-28



F-29

5) **CHECK** the distance of the shim washers of the shift shaft both on the crankcase and on the part, and fill any gaps with other shim washers, as shown in the photo (F.30). The end float must be less than 0.1 mm.



F-30



F-31





**6) ENSURE** that the clutch assembly is in working order.

To do so, ensure that the iron discs are in good condition, that the notches on the cork discs are not too deformed and that their coating is not burnt. Check that the grooves on the clutch boss are not too deeply marked; perform the same check on the slots of the clutch housing. Also check that the **clutch springs are not shorter than the permissible threshold of 29.5 mm (F.31)**; if they are shorter replace them.

**7) CAREFULLY** clean the carbon crust from the piston top by means of a common scraper, taking care not to damage the piston itself. Check the piston skirt for streaks or seizing. Check that it is firmly mated to the lubricated piston pin, the surface of which must be in perfect condition. Make sure that the piston pin can be fitted by manual pressure and that it does not yield under its own weight.

**8) CHECK** the piston rings for faults of any type and make sure that the clearance between the two ends is within the values shown in the chart.

RINGS	DISTANCE
New	0,15 ÷ 0,30 mm
Used	Up to 1,2 mm

The checks must be carried out using a feeler gauge. The piston ring must be placed in the cylinder in a horizontal position (F.32).

**9) CHECK** that the cylinder water jacket does not have seizing notches or wear and that there is no scoring of any kind. By means of a bore gauge, check the cylinder bore in two directions at 90° the one from the other (one parallel and the other perpendicular to the axis of the piston pin) (F.33). The maximum permissible ovalisation is 0.03 mm, exceeding which the cylinder must be replaced.



F-32

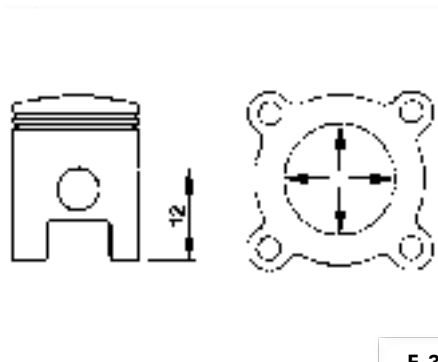

F-33

Repeat the measurements in several positions along the cylinder jacket, between the top face of the cylinder and the exhaust gap (F.34).

Then check the diameter of the piston and compare it with that of the cylinder (F.33).

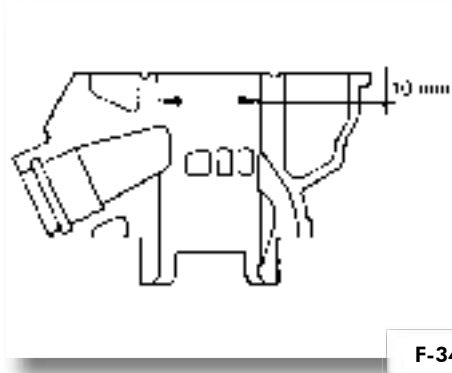

F-34

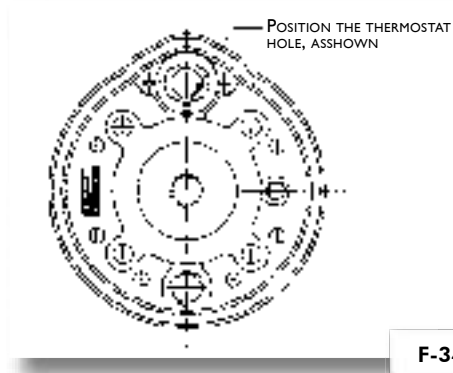

F-34

The maximum end float is 0.10 mm, exceeding which, the piston should be replaced. See the chart below.

		COUPLING CHART		
ENGINE TYPE	MIN/MAX PLAY	TOLE. PISTON	TOLE. CYLINDER	SELECTION
AM6 50 (WATER COLLED)	0.049	-0,063 -0,057	-0,007 -0,002	Y
(CYLINDER IN GHISA)		-0,056 -0,050	-0,001 -0,006	Z
(CAST IRON CYLINDER)	0.062	-0,049 -0,043	-0,007 -0,012	V

**Important:** maintain the same identification letters on the cylinder and piston. The cylinder identification letter can be found on the flat surface of the oiler.

### 10) WATER PUMP

- Place the clutch crankcase (right hand side) on a flat surface.
- Fit the oil seal in the right direction, as shown (F.35).
- Fit the impeller, gasket, dowels and water pump cover.

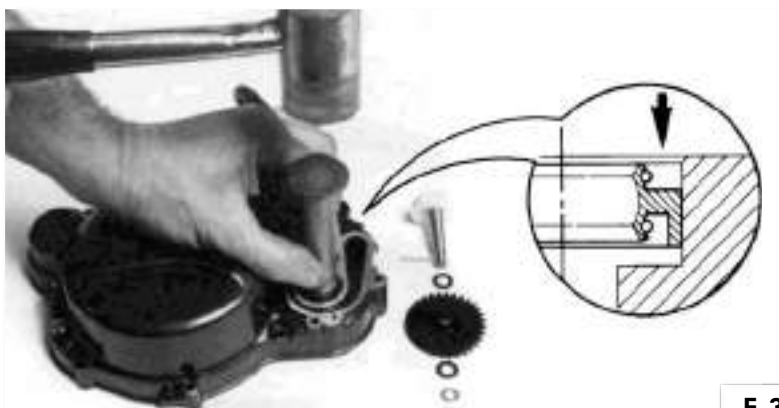

F-35





## 2.5 ENGINE REASSEMBLY



1) **PLACE** the clutch crankcase (right hand side) on a flat surface. Then, fit the spring and the gear selection poppet ball in their seats and apply **grease** to prevent them falling out.

2) **PREPARE** the transmission assembly (primary/secondary) keeping all components together (F.36). Put a 0.6 mm shim washer under the 1<sup>st</sup> speed gear and position the fork in the 3<sup>rd</sup> and 4<sup>th</sup> primary gear (F.36).

**LOWER** the assembly thus formed into its seats (F.37).

Raise the 5<sup>th</sup> speed gear on the secondary shaft and insert the fork (F.38).

Fit the other fork (6<sup>th</sup> speed gear) into its seat (F.39).



F-36



F-37



F-38



F-39

**3) FIT** the desmodronic shaft (F.40). Insert the fork guide pins into the desmodronic shaft (F.41).  
Fit the fork guide rod into its seat (F.42).

Turn the desmodronic shaft until it reaches the position shown in the figure (F.43).

***N.B.:*** these operations must be effected without forcing (with a hammer or other tools).



F-40



F-41



F-42



F-43



**4) INSERT** the shift shaft with the lower washers (0.6 mm thick) (1- F.44) and insert the return spring hooks in the relevant anchoring bridge (F.45) then check that:

- By putting the desmodronic shaft in 3<sup>rd</sup> speed, make sure the rollers of the cam are at an equal distance from the fork hooks. On the contrary, slightly bend the ends of the spring until obtaining the requested condition.



F-44



F-45

**5) FIT** the countershaft in the clutch crankcase.

***N.B.: assembly of the countershaft in its seat implies no interference.***

**6)** If it has been removed, **FIT** the connecting rod in the **crankcase on flywheel side** using the tool (1 - F.46); keep the connecting rod at the T.D.C. whilst tightening the screw, until the connecting rod touches the bearings.

**7) FIT** the dowel bolts (1-2 - F.47), apply gasket paste on the mating sides of the crankcases (F.47) and oil all shafts. Place the crankcase (flywheel side) over the other crankcase and tap gently all over with a wooden, leather or plastic mallet until the crankcases are joined.



F-46

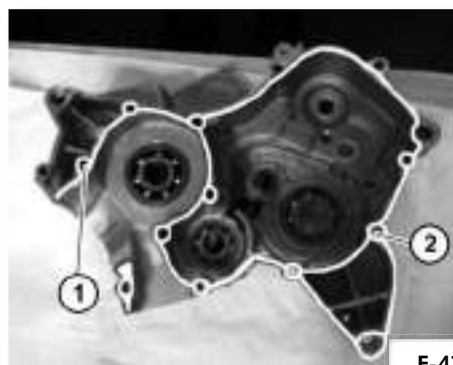

F-47

**8) FIT** the 13 fixing screws and tighten in place (**Cs** 1.0 ÷ 1.2 kg\*m). Make sure all shafts can turn freely. Make sure that none of the shafts feature excessive end play, in which case, separate the crankcases and replace the top shim washer with another having a more suitable thickness.

**9) FIT** the new oil seals, using the specific plug for each.

**10) FIT** the key for the magneto flywheel; put the stator in its seat and fasten in place with the fixing screws (**Cs** 0.25 ÷ 0.3 kg\*m). Fit the rotor and tighten the nut (**Cs** 4.3 ÷ 4.5 kg\*m), using the usual wrench (F48).

**11) FIT** the sprocket: snap ring (1-F49) - sprocket (2) - snap ring (1) - fit the clutch control pin (3- F49) with its return spring (4-F49).



F-48

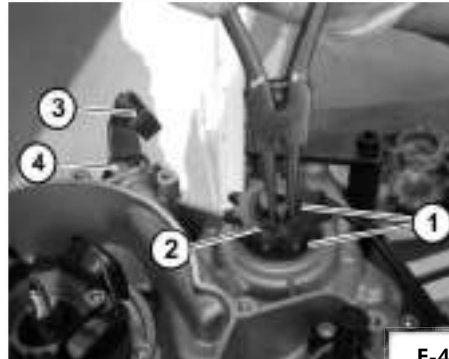

F-49

**12) CHECK** operation of the sprocket and gear wheel pair. If any of the gears needs to be replaced, it is recommended to replace the pair since this will ensure smoother and quieter operation.

**13) FIT** the crankshaft (clutch side) in the following order:

- 1) The overturned oil seal** (1 - F.50), using the special plug (2 - F.50)
- 2) The O-ring** (1 - F.51)
- 3) The spacer** (2 - F.51), with the bevelled side facing the crankshaft. Push in place until it stops.



Now fit the key (1 - F.52), the countershaft drive gear (2 - F.52), the drive sprocket and the nut (**Cs** 6.7 ÷ 7.5 kg\*m). Fit the key and driven gear on the countershaft (2-F.53), making sure that the reference notches on the two gears match (F.53). Tighten the nut (**Cs** 4.5 ÷ 5.0 kg\*m) (**apply Loctite 242**).



F-50



F-51





F-52

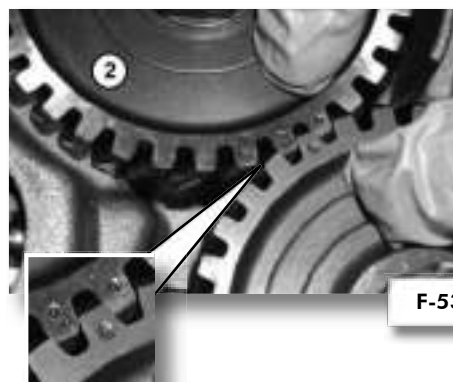

F-53

**14) PROCEED** in reverse order. Refit the clutch assembly and remember to replace the nut fixing washer with a new one; fit the clutch boss fixing nut (**Cs** 5.5 ÷ 6.0 kg\*m) and bend the tab.

**15) FIT** the following components on the output shaft, in the order given: clutch rod (**grease** beforehand), ball and disc pusher.

**16) FIT** the clutch disc assembly in the order shown in (F.54); the iron discs (1-2-3 F.54) should be fitted with the notch, highlighted by the arrows, at 120° the one from the other, starting from the notch facing upwards on the first disc. Fit the last clutch disc, making sure it is timed with the boss (F54b).

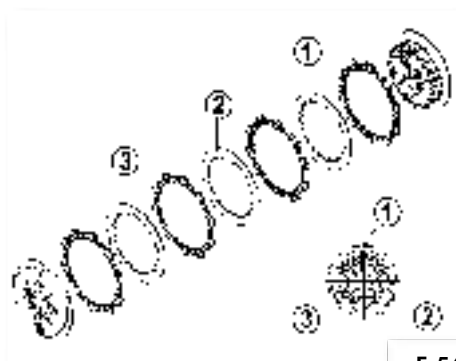

F-54



F-54b



F-55

**17) FIT** the springs and fixing screws and tighten (**Cs** 0.3 ÷ 0.5 kg\*m).

**18)** Correct operating position of the clutch is obtained when the lever, in the position indicated by the arrow (F.55), is parallel to the cover resting surface.

To obtain this condition, turn the adjustment screw (1-F.56) on the last disc, using the special wrench (2- F.56). Tighten the nut (**Cs** 2.6 ÷ 2.8 kg\*m) .

**19) BEFORE** fitting the starter assembly (version without an electric starter), make sure that the phase between the pawl on the sliding rod and the hole for fixing the spring is the same as before disassembly (90° - F.57).

**20) FIT** the starter assembly, whilst hooking the spring to the hub on the cover.

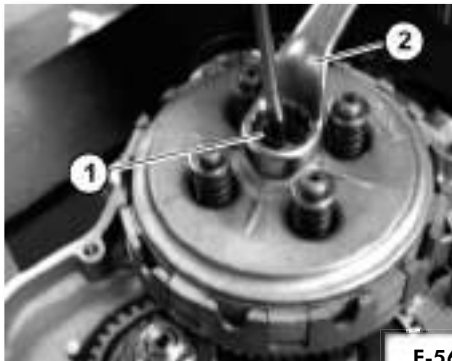

F-56



F-57

**21) FIT:** the dowel bolts and a new gasket on the crankcase; the clutch cover; if necessary, this operation can be made easier by turning the impeller of the water pump. Secure in place with screws (**Cs** 1.0 ÷ 1.2 kg\*m).

If you have disassembled it, refit the oil pump, making sure that the O-ring is in working order (I - F.58a).



**When refitting, take care not to damage the oil pump gear.**

Whilst fitting the starter lever on its shaft, turn it 180° counter-clockwise and secure in place with the fixing screws (**Cs** 2.9 ÷ 3.0 kg\*m) (F.58b).

This operation must be performed to pre-load the return spring.



F-58a



F-58b



**22)** Before assembly, **CHECK** the condition of the cage on the piston pin and its rollers. Fit the piston, making sure that the arrow marked **on the top is facing towards the exhaust side** (F.59), and therefore towards the piston pin and its circlips.



F-59



F-60

**23)** In the order indicated, **FIT** the piston rings, making sure that the ends are correctly positioned in the seats on the piston; a new cylinder gasket; the cylinder; the centre cylinder O-ring in the stud bolts; the O-ring on the cylinder head; the head (clean beforehand). Tighten the nuts evenly and diametrically (**Cs** 1.4 ÷ 1.6 kg\*m); check the position and tightness of the O-ring on the cylinder head.

**24)** **FIT** the reed valve (F.60), followed by the exhaust manifold, tightening the four screws evenly and diametrically (**Cs** 0.9 ÷ 1.1 kg\*m).

**25)** **REFIT** the flywheel cover, a new gasket and its fixing screws, which must be tightened (**Cs** 0.1 ÷ 0.2 kg\*m).

**26)** **REFIT** the oil drainage bolt, replace the gasket and secure firmly in place (**Cs** 1.7 ÷ 1.8 kg\*m).

**27)** **POUR** oil into the engine (0.750 kg) through the hole at the top.

### 2.6 ENGINE SERVICING AND COMMISSIONING SCHEDULE

MAINTENANCE OPERATIONS	AFTER 1000 KM OR 3 MONTHS	EVERY 5000 KM
<b>Check</b>		
Adjustment of engine idling speed	X	X
Gas and oil pump control	X	X
Front and rear brake control	X	X
Operation of the electrical equipment	X	X
Petrol ducts	X	X
Oil ducts	X	X
Front and rear brake liquid ducts	X	X
Coolant duct	X	X
Fuel heating duct	X	X
Tire pressure	X	
Tire condition, pressure and wear		X
Level of front and rear brake liquid	X	X
Level of coolant	X	X
Level of battery electrolyte	X	X
Screw tightness	X	X
Battery charge level		X
<b>Replace</b>		
Air filter filtering element		X
Front and rear brake pads		X
Gearbox oil		X
Chain - pinion - gear wheel	X	X
Clutch discs		X
Spark plug		X
<b>Check and/or replace</b>		
Piston		every 10.000km
Cylinder head		every 10.000km
Discharge gap		every 10.000km
<b>Check and lubricate</b>		
Chain tightness and condition	X	X
<b>Check and adjust</b>		
Clutch control	X	X
Oil pump control	X	X
Headlight height	X	X
<b>Clean and adjust</b>		
Carburettor		X
<b>Vehicle test</b>		
Road test	X	X







2.7 PARTS AND THEIR TORQUE WRENCH SETTINGS

	PART POSITION	PART NAME	SCREWS	TORQUE SETTING		QTY.
				N*m	Kg*m	
1	Spark plug	Spark plug	14 x 1.25	20÷25	2÷2,5	1
2	Cylinder head	Nut	M7 x 1	14÷16	1,4÷1,6	4
3	Cylinder head	Pipe fitting	M8 x 1.25	24÷26	2,4÷2,6	1
4	Cylinder head	Temperature probe	M14 x 1.25	16÷20	1,6÷2,0	1
5	Countershaft	Hex. nut	M12 x 1	45÷50	4,5÷5,0	1
6	Water cooling (head)	T.C.B. screw	M4 x 0.7	2,5÷3,5	0,25÷0,35	2
7	Water pump body	T.C.C.E. screw	M6 x 1	4÷6	0,4÷0,6	1
8	Pipe coupling	T.C.C.E. screw	M6 x 1	4÷6	0,4÷0,6	1
9	Water pump body	T.C.C.E. screw	M6 x 1	4÷6	0,4÷0,6	1
10	Water pump body	T.C.B. screw	M6 x 1	4÷6	0,4÷0,6	1
11	Oil pump	T.C.C.E. screw	M5 x 0.8	6÷8	0,6÷0,8	2
12	Oil pump lid	T.C.C.E. screw	M5 x 0.8	3÷4	0,3÷0,4	2
13	Intake manifold	T.C.C.E. screw	M6 x 1	9÷11	0,9÷1,1	4
14	Crankcase	Stud bolt	M7 x 1	10÷12	1,0÷1,2	4
15	Cover, clutch side	T.C.B. screw	M6 x 1	2÷4	0,2÷0,4	1
16	Crankcase, flywheel side	T.C.C.E. screw	M6 x 1	10÷12	1,0÷1,2	13
17	Crankcase, clutch side	Hex. screw	M8 x 1.25	17÷18	1,7÷1,8	1
18	Crankcase, flywheel side	Neutral indicator light	M10 x 1.25	1÷2	0,1÷0,2	1
20	Crankcase, clutch side	Hex. screw	M12 x 1.25	24÷26	2,4÷2,6	1
21	Cover, clutch side	T.C.C.E. screw	M6 x 1	10÷12	1,0÷1,2	7
22	Cover, flywheel side	T.C.C.E. screw	M5 x 0.8	1÷2	0,1÷0,2	5
23	Primary gear (Clutch side)	Nut	M12 x 1.25	65÷75	6,5÷7,5	1
24	Clutch boss	Hex. screw	M12 x 1.25	55÷60	5,5÷6,6	1
25	Disc boss (clutch)	T.C.C.E. screw	M5 x 0.8	3÷5	0,3÷0,5	4
26	Disc pusher (clutch)	Hex. nut	M14 x 1.25	26÷28	2,6÷2,8	1
27		Clutch adj. screw	M14 x 1.25	turn until it stops		1
28	Selector	Hex. nut	M7 x 1	14÷16	1,4÷1,6	1
29	Magneto flywheel	Screw	M4 x 0.7	3÷4	0,3÷0,4	3
30	Magneto flywheel	Hex. nut	M10 x 1.25	43÷45	4,3÷4,5	1

2.8 EXPLODED VIEW OF THE ENGINE AM6 EURO2

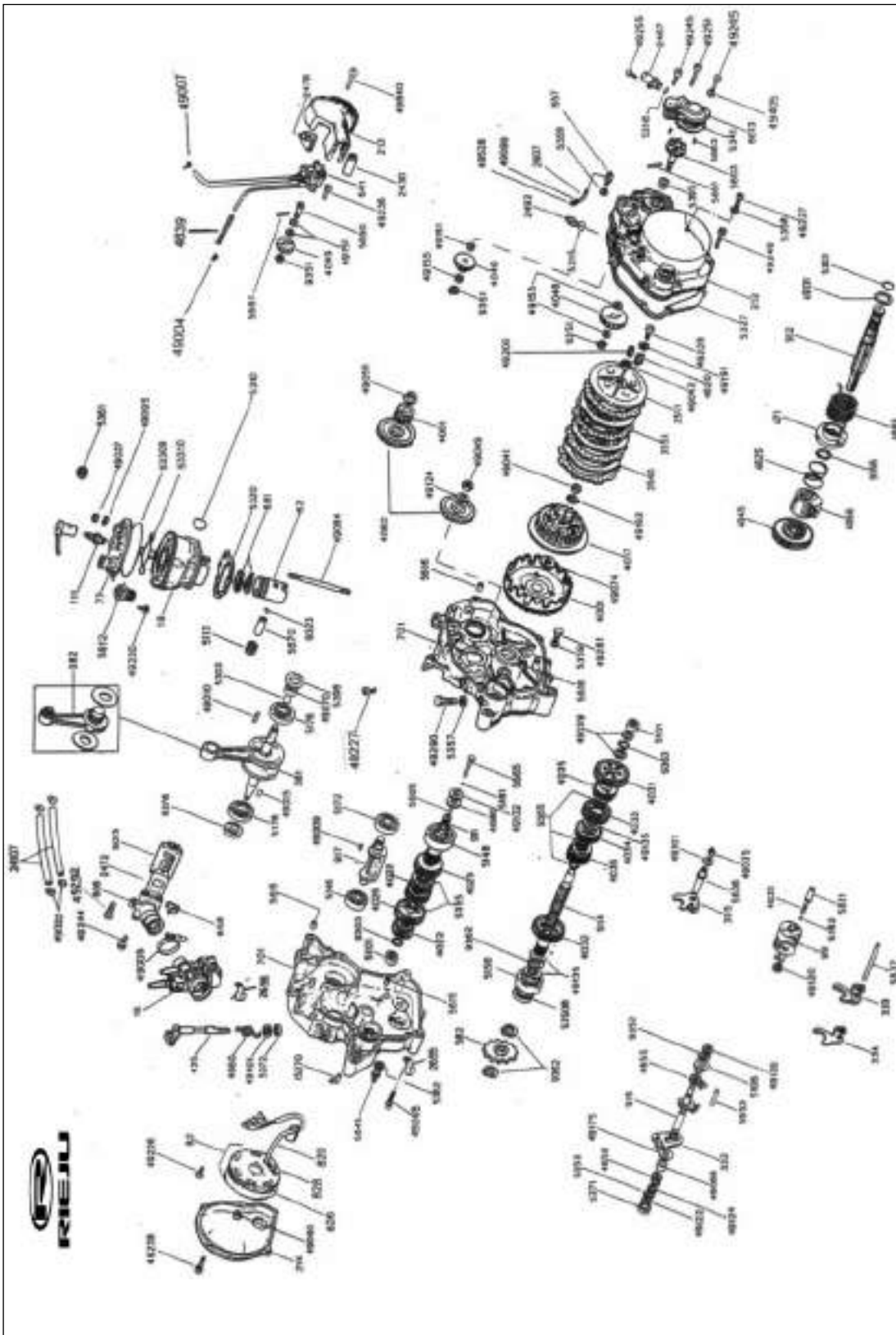



**RIEJU**

Telf. +34 / 972500850 Fax +34 / 972506950

RIEJU, S.A. c/.Borrassà, 41

E-17600 FIGUERES, GIRONA (SPAIN)

[www.riejumoto.com](http://www.riejumoto.com) / e-mail [rieju@riejumoto.com](mailto:rieju@riejumoto.com)