



# UKKO S

Owner's Manual Please read this manual carefully before riding and keep it properly.

[www.tromox.com](http://www.tromox.com)

\* The graphic illustrations in this manual may not reflect exact appearance of actual products

\* Specifications subject to change without notice , so as improvement of quality and performance of product.



## Declaration:

1.The pictures, technical information, data, instructions and other information contained in this manual have been checked as necessary before it is printed. However, in order to continuously develop and improve the product, and make this manual meet customers' demands, we reserve the right to make changes as necessary without further notice.

2.Copy, store or transcribe any content in this manual in any text or document without the written authorization and permission of Hangzhou Tromox Technology Co., LTD is forbidden and illegal.

3.The corresponding spare parts and accessories of Hangzhou Tromox Technology Co., Ltd. are independently designed and purchased, which are applicable to your vehicle under any circumstances. Please be sure to use the original genuine parts. Tromox will not guarantee the suitability and safety of the spare parts and accessories that are not produced by our company, and has no obligation to any loss caused by the use of spare parts and accessories that are not produced by our company.

## Foreword

Congratulations and thank you for purchasing Tromox models and related services.

In this manual, the basic operation and maintenance of Tromox MS4000D, and MS2500DQ electric two-wheeled motorcycle and Tromox are introduced in details. Please read this manual carefully before riding.

The correct operation and maintenance can effectively ensure the safe riding, best performance of electric motorcycle and prolong its service life.

Our distributors have the technical teams trained by Tromox, who can provide the best maintenance and services for you.

The data, specifications and instructions in this manual are determined according to the current design, and the right of changing and interpretation belongs to Hangzhou Tromox Technology Co., Ltd. For the future technical changes to this electric motorcycle, please refer to our website:

[www.tromox.com](http://www.tromox.com) or "TROMOX UKKO" APP information update.

Wish you a safe journey!

## Table of Contents

User Instructions	03	■ Use, Maintenance & Installation of Battery	14
Safety Instructions	04	■ Use of Charger	19
MS4000D and MS2500DQ Technical Specifications	05	■ Anti-theft Alarm & NFC Start	20
Instructions for Use	06	■ Remote control instructions	21
■ Exploded Views of Vehicle Parts	06	■ TROMOX APP	22
■ Name plate&Position of vehicle		Operational Guidance	27
Identification Number	09	■ Pre-ride Inspection	27
■ Dash Settings	10	■ Vehicle operation	28
■ Left Handlebar Controls	11	Maintenance	32
■ Right Governor Handlebar controls	11	Troubleshooting	35
■ Tires	11	After-sales Service	36
■ Chain sprockets,Chain,and tightness degree	12	■ After-sales Service and Warranty Information	36
■ Belt pulley, Belt, and Tightness Degree	13	■ Limited Warranty	38
		Electrical Schematic Diagram	40

## User Instructions

---

1. Before riding, please take your time to carefully read and fully understand all the information in this manual, not limited to instructions, attention points, and warning information; please thoroughly check whether all components are in good conditions. If you find any problem, make sure to contact Tromox distributor or authorized service shop right away.
2. Don't attempt to operate the vehicle until you have attained adequate knowledge of the operation features, warnings and cautions.
3. Please thoroughly check the warning labels of the vehicle.
4. It is strictly prohibited to refit, disassemble or change the circuit of this motorcycle. If any repairing or replacement is required, please only use Tromox approved parts and accessories from our distributors or authorized service shops.
5. Please reserve this operation manual properly.

## Safety Instructions

---

For the safety of yourself and others, please obey the following instructions:

1. Ones that are not subjected to formal training or without license are strictly forbidden to drive this motorcycle.
2. Please wear the approved helmet produced by the reliable manufacturers while riding to reduce the risk of potential injury.
3. MS4000D/MS2500DQ can be used for maximum two passengers.
4. Please don't ride this electric motorcycle when you are drunk, tired, feeling unwell or after taking any medicine that may affect your driving ability.
5. Loading capacity includes carriage of passenger, luggage or accessories must be in accordance with the local corresponding laws or regulations, so as to avoid the danger initiatively.
6. In case of rainy and snowy weather or on wet and slippery roads, the braking distance would be longer, please slow down and don't brake suddenly to avoid collapse. In addition, don't ride this electric motorcycle under bad weather conditions such as storms and typhoons.

## Safety Instructions

---

7. On the road with poor lighting, please turn on the headlight to ensure the safety of yourself and others; if the electric motorcycle has to be pushed due to low battery, the emergency flashers must be turned on.

8. If the vehicle will not be used for several days, please turn off the air switch in advance to prevent the battery from being discharged.

9. When leaving the electric motorcycle, please make sure to turn it off and keep it away from the small children.

10. Since this vehicle is powered with lithium-ion battery, please obey the following safety principles to avoid accident:

10.1 Please don't park the vehicle in the building entrance hall, emergency escape, corridor or exit.

10.2 The vehicle shall not be parked or charged in the residential buildings, and shall be kept away from combustible materials during charging. Please disconnect the charger as soon as the battery is fully charged.

10.3 Please use the battery properly and pay attention to its warning labels. The waste battery must not be disassembled, but should be sent to the related professional companies for recycling.

10.4 Please read and understand the safety and warning terms of the charger. The replaced charger should match the battery model.

10.5 Please read and understand the cleaning instructions.

11. Items checked before riding:

11.1 Check whether the headlight, turn signal light, tail light, brake light, license plate light and horn are in normal condition.

11.2 Check whether the front and rear brakes perform normally, whether the fixing bolts of brake caliper are tightened and whether the power will cut off when user presses the brake.

11.3 Check whether the tire pressure is normal.

11.4 Check whether the handlebars and front & rear wheels are fastened.

11.5 Check whether the reflectors are damaged or contaminated.

11.6 Check the rearview mirror: you should be able to clearly see the rear 10 meters range from the rearview mirror by sitting at the driving position.

If there is any abnormality, please seek for the professional maintenance in time.

## MS4000D and MS2500DQ Technical Specifications

---

Item	Technical Specification	Item	Technical Specification
Size (L x W x H)	1855mm x 800mm x 1045mm	Nominal voltage	System: 72 V Lightning: 12 V
Wheel base	1295 mm	Battery type	Ternary lithium battery
Curb weight	110 kg	Battery specifications	72V55Ah
Maximum loading capacity	150 kg	Charging current of charger	Standard: 10A Optional: 15A
Maximum gradeability capacity	MS4000D: 22° MS2500DQ: 15°	Rated power of motor	MS4000D: 4000 W MS2500DQ: 2500 W
Tire specifications	Front Tire: 100/80-14 Rear Tire: 120/70-14	Controller type	FOC vector controller
Rim specifications	Front Rim: MT2.50x14 Rear Rim: MT3.50x14		

## Instructions for Use

### ▪ Exploded Views of electric motorcycle Parts (Left Side View)

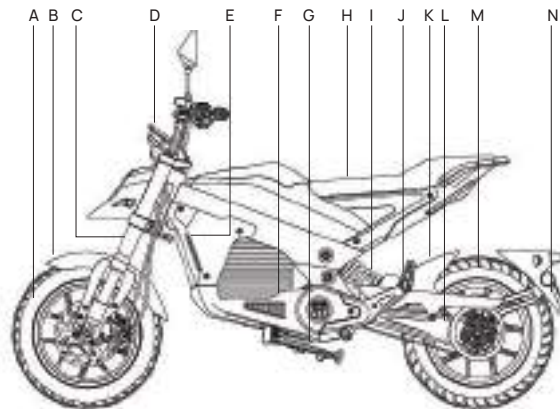

Left View

- |                        |                  |                             |                     |
|------------------------|------------------|-----------------------------|---------------------|
| A.Front wheel          | B.Front fender   | C.Front left shock absorber | D.Dashboard         |
| E.Left decorative lamp | F.Bottom shield  | G.Side stand                | H. Seat cushion     |
| I.Rear shock absorber  | J.Left foot pegs | K.Rear fender               | L.Single rocker arm |
| M.Rear wheel           | N.Rear cover     |                             |                     |

## Instructions for Use

### ▪ Exploded Views of electric motorcycle Parts (Right Side View)

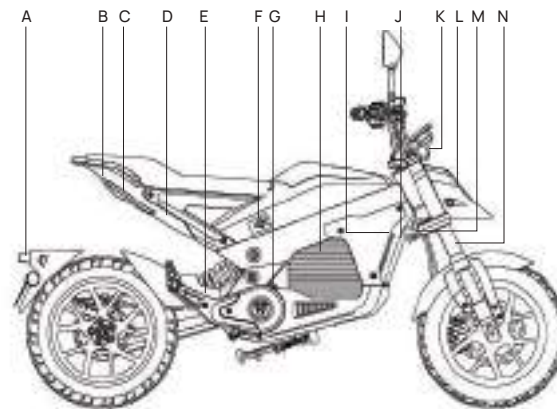

Right View

- |                                |                              |                |                        |
|--------------------------------|------------------------------|----------------|------------------------|
| A.Rear registration plate lamp | B.Rear camera                | C.Tail light   | D.Seat lock            |
| E.Right foot pegs              | F.Charging interface         | G.Motor        | H. Battery compartment |
| I.Right decorative lamp        | J.Motor controller           | K.Front camera | L.Headlight            |
| M.Head lock                    | N.Front right shock absorber |                |                        |

## Instructions for Use

### ▪ Exploded Views of Vehicle Parts (Vertical View)

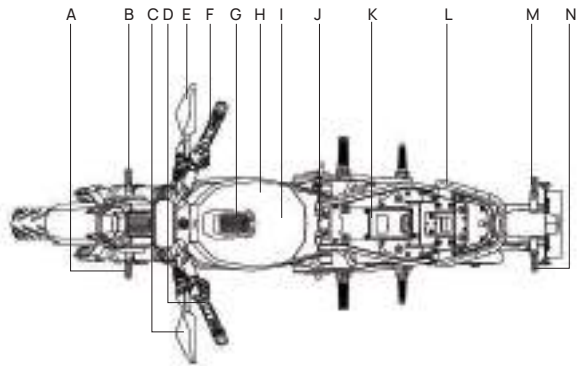

Vertical View

A.Front left turn signal

B.Front right turn signal

C.Left rearview mirror

D.Left switch

E.Right rearview mirror

F.Right handlebar switch

G.Breathing light

H. Battery cover

I.NFC

J.Air switch

K.VCU

L.Rear handrail

M.Rear right turn signal

N.Rear left turn signal

## Instructions for Use

### ▪ Name plate & Position of vehicle Identification Number (VIN)

- ① VIN: on the right side of the head tube of the frame
- ② Certification label: on the left side of head tube of the frame
- ③ Motor serial number: is etched on the right hand side of the motor housing and is visible when the motorcycle is fully assembled.

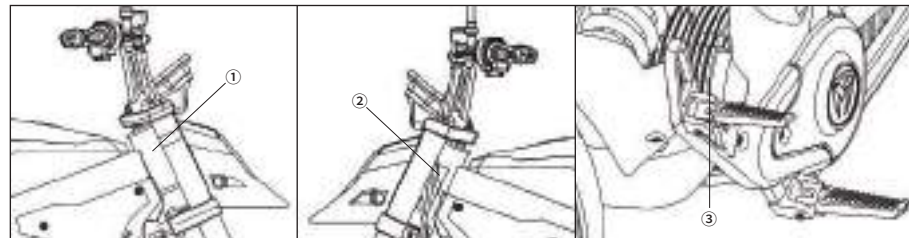

# Instructions for Use

## ▪ Dash settings

### TFT dashboard

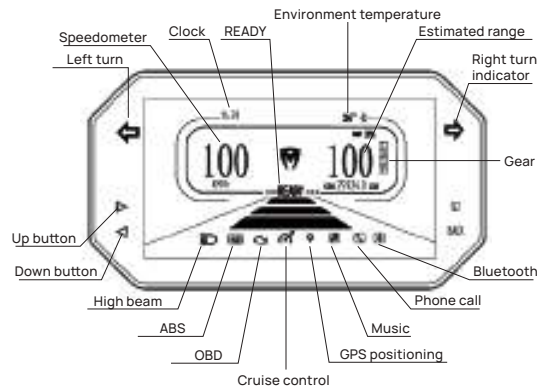

### VA dashboard

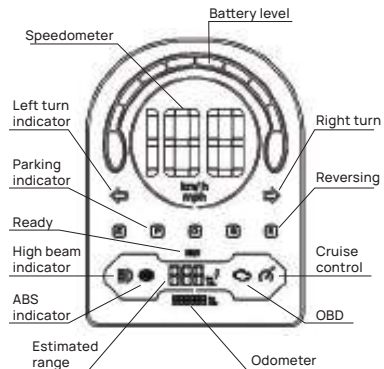

### 1. TFT dashboard setting

1. Press the SET button for two seconds and release it to enter the setting page, enter the menu with the up and down buttons to select the functions that need to be adjusted, and press the SET button to confirm.

# Instructions for Use

## ▪ Left Handlebar Controls

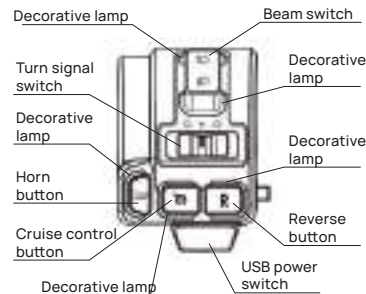

### Gear select instructions:

E: Beginner mode: speed 0~30km/h  
 D: Daily use mode: speed 0~60km/h  
 S: Sport mode: speed 0~Max.

## ▪ Right Governor Handlebar Controls

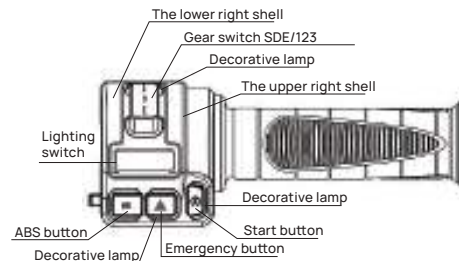

### Tires

1. Specification of front tire: 100/80-14  
 Pressure: 225kPa±25kPa
2. Specification of rear tire: 120/70-14  
 Pressure: 280kPa±25kPa

## Instructions for Use

---

- Chain sprockets, chain, and tightness degree

- 1.Chain sprockets: Rear: 428-46T, Front: 428-15T

- 2.Chain: GB/T14212 428MH-110

- 3.Tightness degree:

- (1) Measure the chain at the lower end of the middle of the sprocket;

- (2) When the tightness is correct, the swing amplitude of the chain at this position is 15-25mm.

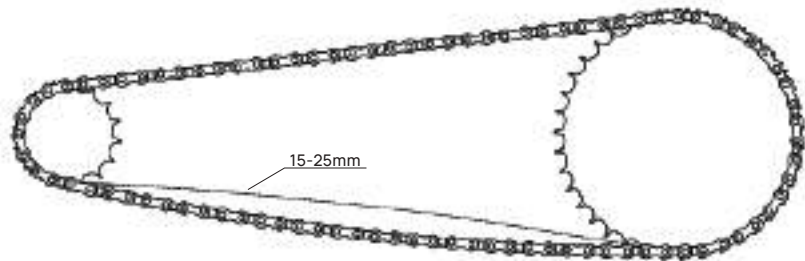

## Instructions for Use

---

- Belt Pulley, Belt, and Tightness Degree

1. Belt Pulley: Rear P69-S8M, Front P26-S8M

2. Belt: STD1344-8M

3. Tightness Degree:

- (1) Place the belt tension meter probe close to the belt at the lower end of the middle of the pulley;

- (2) Use your fingers to move the belt at this part;

- (3) Read the value on the tension meter, the correct tightness value is 105~110Hz.

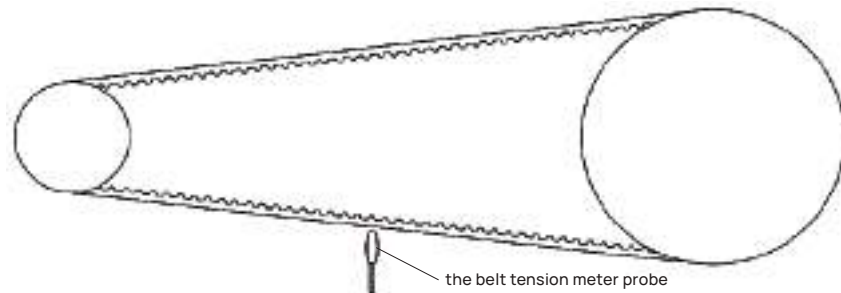



## Instructions for Use

### ■ Use, Maintenance & Installation of Battery

#### Body charging

① Locate the charging cover on the right side of the vehicle.

② Insert the charger output plug into the body charging port, and then insert the AC input plug of the charger into the socket. The indicator light is red during charging, and will turn green after the battery is fully charged. While charging is done, disconnect from the AC power source right away.

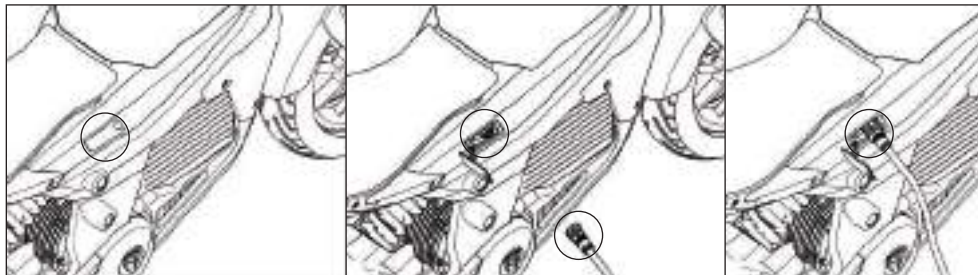

## Instructions for Use

### 2. External charging

① Use the key to turn right to unlock the battery cover (The keyhole is located at the bottom of the seat);

② open the cover to 20°~30°. Lift the upper cover slightly, but do not lift it too high to avoid damage to the components;

③ Pull the battery cover forward about 2cm, stretch the upper cover diagonally upward;

④ Open the battery cover to the end after extending.

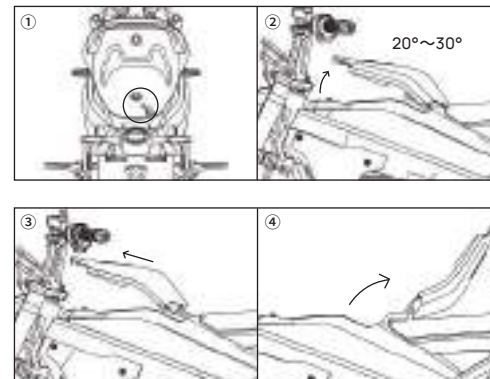

## Instructions for Use

⑤ Turn off the air switch, open the battery strap and pull out the battery cable plug.

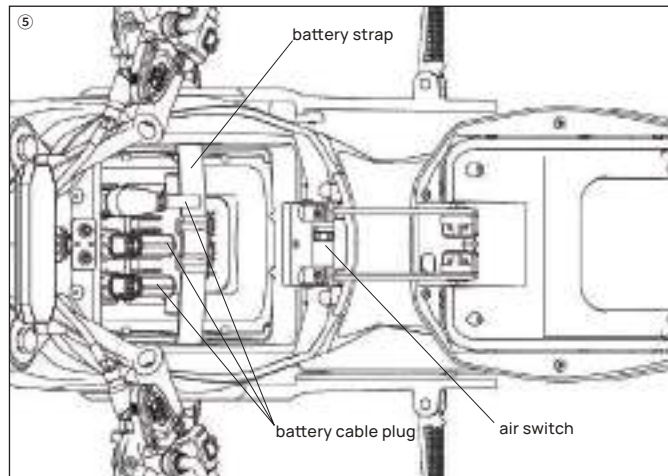

## Instructions for Use

⑥ Pull out the battery cable plug to lift the battery, then first insert the charger output plug into the battery charging port, and then insert the charger AC input plug into the socket. The indicator light is red during charging, and will turn green after the battery is fully charged. While charging is done, disconnect from the AC power source right away.

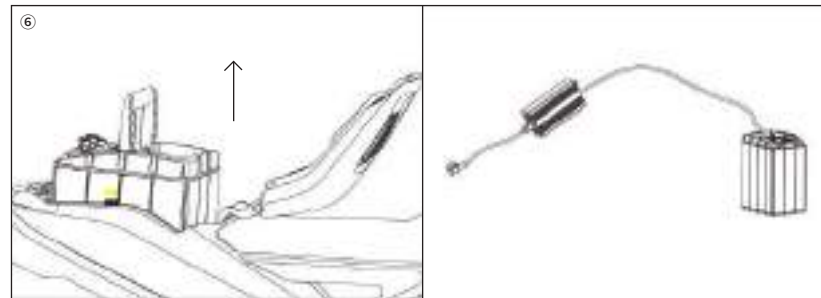

⑦ To install the battery, just reverse the steps of removing the battery.

## Instructions for Use

---

### 3. Special attention:

Before using the battery, please read the operation instructions carefully. Failure to follow the guidelines may damage the battery, for instance, battery heats up, catches fire, burst or even more serious consequences.

- ①Protect the battery pack from being sprayed by water or soaked in water;
- ②Discharging temperature: -20°C-60°C; charging temperature: 0°C-45°C;
- ③If the vehicle is left unused for long time, please make sure to remove the battery and keep it properly. The battery shall be charged as it

is used. In addition, the state of long-term storage of the battery is half-saturated (after the battery is fully discharged, charge it with a charger for 2 to 3 hours). In order to prevent the battery from over-discharging, it is required to charge it every 1 month; the battery should be stored in dry and well-ventilated places, keep it away from combustible materials. The safe storage duration and temperature range are as follows:

1 month: -20°C-60°C;

3 months: -20°C-45°C;

1 year: -20°C-25°C;

Leaving the battery stored more than 1 year could damage the power pack and void the warranty.

- ④The input and output terminals of battery must not being short circuited; the reverse polarity connection of battery positive and negative terminals on the charger or external device are prohibited;
- ⑤Don't throw the battery into fire. Store and keep the battery away from children, fire and heat sources. Don't smash or drop the battery, so as to prevent it from being pierced. Don't disassemble the battery or change its external structure; all these incorrect behaviors may cause serious damages.
- ⑥Before charging, please check whether the charger matches the battery model. If the charger has to be replaced, make sure to visit our distributor or authorized service shop to obtain the approved charger.
- ⑦If the battery is on fire, please cut off the surrounding power supply promptly and use FE-36 fire extinguisher to extinguish and cool down the battery. In case the right extinguisher is not available, the water base extinguisher can be applied. However, the dry powder extinguisher is not applicable for this case.
- ⑧If there is any question, please contact our distributor or after-sales service department.

## Instructions for Use

---

### Use of Charger

1. Before use, check the charger specification firstly. Don't use the charger with undesignated model.
2. The charger is waterproof grade IP×1. It is strictly prohibited to store and use the charger in rainy or humid outdoor environment.
3. Don't use the damaged wires for charging.
4. It is strictly prohibited to plug/unplug the charger with wet hands.
5. Don't use the charger in the place with heat source or under direct sunlight..
6. Don't use the charger close to combustible materials and explosive gas.
7. It is strictly prohibited to block the air inlet/outlet. The space of at least 10cm shall be left at both inlet and outlet sides.
8. Please check whether the plug at the output end of charger is loose before charging. At the time of charging, plug the charger power terminal into the indoor power supply first; then connect the output terminal to the charging port of battery pack.
9. The indicator light is red during charging, and will turn green after the battery is fully charged. While charging is done, disconnect from the AC power source right away.
10. Be sure to unplug the charger when the battery is not being charged or after the completion of charging. First, unplug the output end of the charger; then the AC power end of the charger.
11. Don't carry the non-vehicle-mounted charger during riding, so as to prevent the electronic components from becoming loose or being damaged due to vibration.
12. Please make sure the AC voltage range of AC power supply is consistent with the AC input voltage range of the charger. Please read the instructions carefully before using. All the damages caused by incorrect use shall be attributed to the man-made improper operation, for which the manufacturer is not responsible for.
13. Don't open, repair or disassemble the charger by yourself.
14. It is strictly forbidden to pull the power cord or output cord directly, please use the terminal part to unplug the power cord or output cord.

## Instructions for Use

### Anti-theft Alarm & NFC Start

#### 1.NFC Start

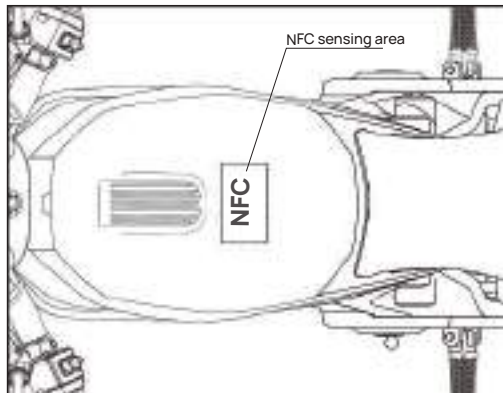

- ①Put the NFC card within 0.3cm of the NFC sensing area to start the vehicle.
- ②Put the NFC card within 0.3cm of the NFC sensing area to turn off the vehicle.

## Instructions for Use

### Remote control instructions

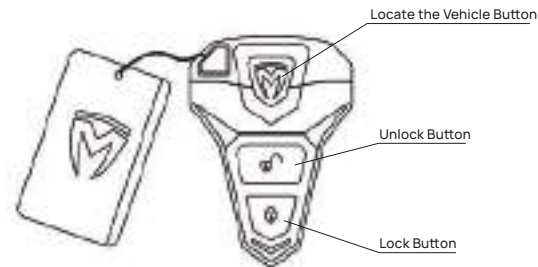

- 2.1 General functions: Locate the Vehicle Function, Anti-theft Setting (power off), Start the Vehicle, Open the Cushion Lock Function;
- 2.2 Locate the Vehicle Function: Press the locate the vehicle button twice to find the vehicle, the vehicle will make sounds and the lights will flash, which enable you to easily check the location of the vehicle.
- 2.3 Anti-theft Setting: Press the lock button once, and the vehicle will be powered off and locked (the vehicle will enter the anti-theft mode in the locked state).
- 2.4 Start the Vehicle: Press the unlock button once, and the vehicle can be powered on.
- 2.5 Open the Cushion Lock Function: Press the locate the vehicle button once to open the cushion lock.

Note: When the vehicle is not in use, please keep the key at least 5 meters away from the vehicle to prevent meaningless power consumption.

# Instructions for Use

## TROMOX APP

### 1. Download and install APP

#### 1.1 Apple IOS

Search "TROMOX UKKO" in APP store to download the APP.

#### 1.2 Android

Search "TROMOX UKKO" in Google Play to download the APP.

### 2. Registration/Login

#### 2.1 Registration

Enter the registration interface. Then, fill in the mobile phone number, verification code and password to complete the registration.

#### 2.2 Login

Log in with the account number (the registered mobile phone number) and password.

#### 2.3 Password Forgotten

If you forget the password, please click "Password Forgotten" and fill in the phone number, verification code, and new password to replace the old one.

#### 2.4 Experience Mode

You can check the function include "vehicle condition", "Information", "Message", and "My" at the home page and exit by clicking My - Setting - Logout. If you want to use more functions, please bind the vehicle first.

# Instructions for Use

## Vehicle condition

Remaining mileage (It shows the test data. Since the riding environment, speed and load are different, the actual remaining mileage may be different from the data on the display. Thanks for your understanding!)

Click the percentage to view more details of battery

Click here to enter the user and vehicle location map

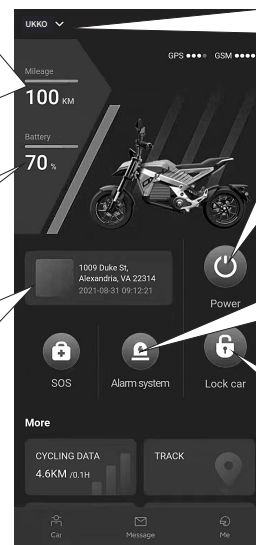

Click the arrow to view the vehicle list and new added vehicles

The start button can be used to turn on or off the vehicle.

The anti-theft alarm switch can be locked or unlocked.

Click the icon to remotely lock the vehicle

## Instructions for Use

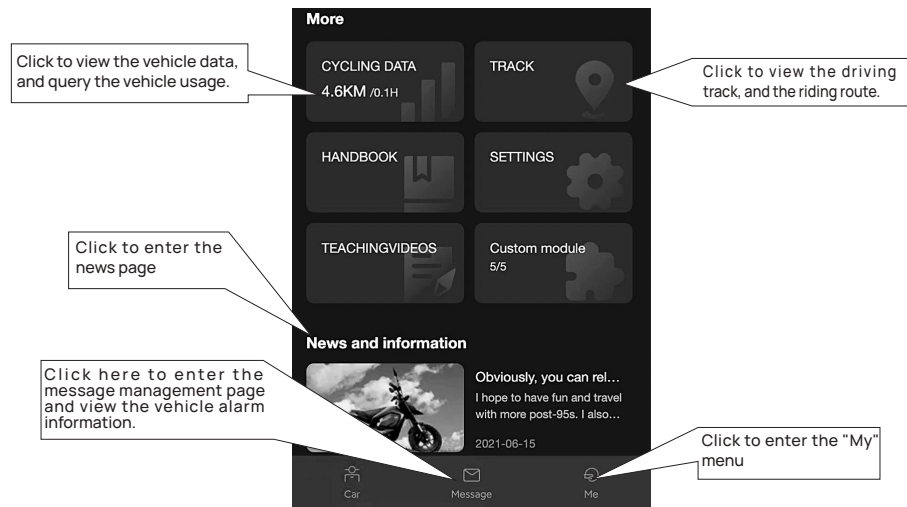

## Instructions for Use

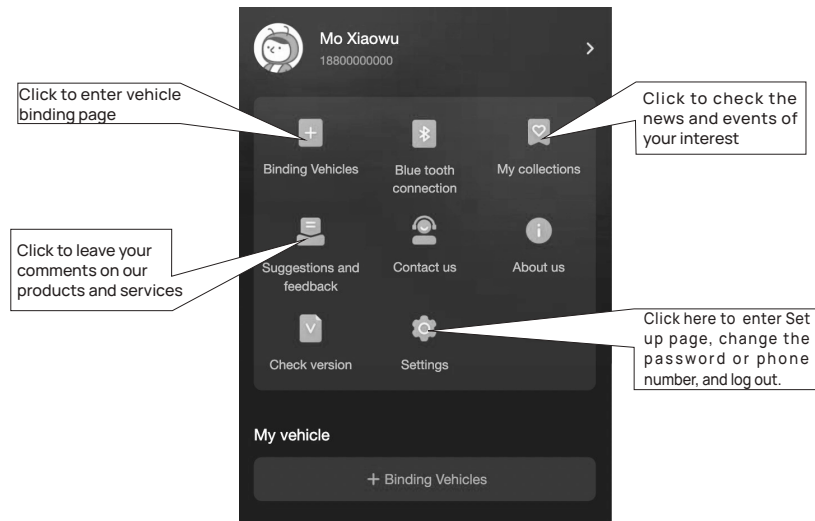

## Instructions for Use

### 3.1 Vehicle binding and unbinding

Click "+ Bind vehicle" in the vehicle list:

3.1.1 Find the barcode sticker at the end of the manual, enter the frame code on the sticker or scan the barcode to bind the vehicle to become the owner.

3.1.2 Scan the "Shared QR Code" (My - Select vehicle - Click "Vehicle Identification Number") of vehicle owner to bind the vehicle. Each user can bind 8 vehicles maximum, each vehicle can be bound to 5 accounts (including vehicle owner).

3.1.3 Click the vehicle binding management page, in which, the vehicle unbinding can be done.

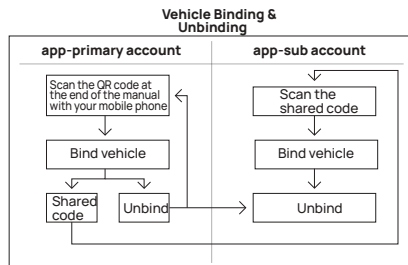

### 3. Anti-theft alarm

a. When the network of mobile phone and vehicle is normal, click the "Anti-theft alarm" switch on the left side to turn on or off the alarm. Turn on the anti-theft alarm to activate the alarming device; turn off the anti-theft alarm to deactivate the alarming device.

b. When the network of mobile phone and vehicle is abnormal, after clicking the "anti-theft alarm" switch, the system will require you to use Bluetooth connection. After the successful connection, user can implement the operation again.

### 4. Replacement of VCU

Only the vehicle owner can replace the VCU. The replacement procedure is as follows: My - Select vehicle - "VCU version" - "Scan QR code to replace the VCU equipment".

## Operational Guidance

Pre-ride Inspection:

1. Check whether the head lock is unlocked, and whether the handlebar is flexible without retardation.
2. Check whether the handlebar is firmly fastened, and whether the left and right handlebar switches work normally.
3. Check whether the rearview mirrors are fastened, and in proper angle, whether they are clean enough, and assure the people and vehicles within the rear 10 meters can be seen clearly.
4. Check whether the tire pressure is within the specified range.
5. Check whether the tire surface has crack or damage, and whether the tread depth is greater than 0.8mm.
6. Ensure that the instrument and mobile phone App have no fault warning after switching on.
7. Check whether the battery is fully charged.
8. Check whether the headlight, tail light and front, rear, left & right turn signal lights work normally.
9. Check whether the horn works normally.
10. Check whether the brake oil is sufficient, and whether the brake handle and brake system work normally.
11. If there is any abnormality, please contact our customer service center.

# Operational Guidance

## Vehicle operation

### Starting methods:

#### TROMOX APP :

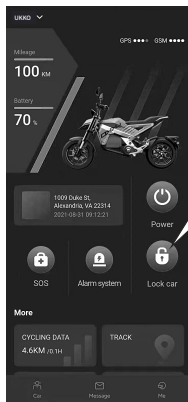

Click here to turn on the power.

#### Remote control:

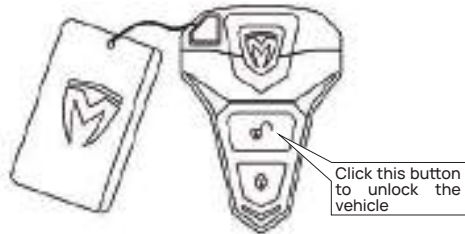

Click this button to unlock the vehicle

# Operational Guidance

## Vehicle operation

#### NFC Start:

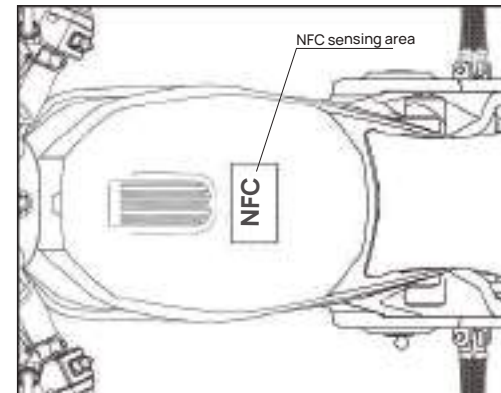

NFC sensing area



## Operational Guidance

Preparations before riding:

- ①Wear your helmet and start journey with Tromox.
- ②Fold the side stand. Then, the indicator light (P) of side stand on the dashboard will be off. (For VA screen only).

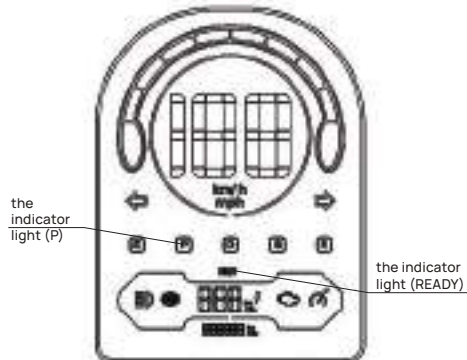
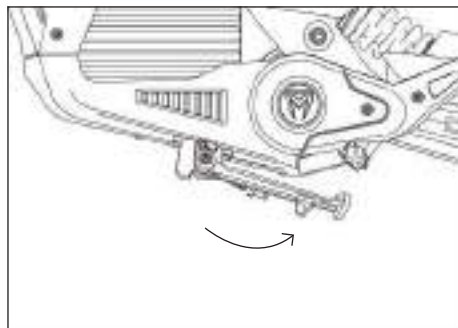

## Operational Guidance

③Press the start button to unlock the parking status,the indicator light "ready" on the dashboard will be on. At this moment, the vehicle is ready to drive! (Press the start button again. Then, the "Ready" indicator light is off and the vehicle is switched to the parking mode. For TFT screen only.)

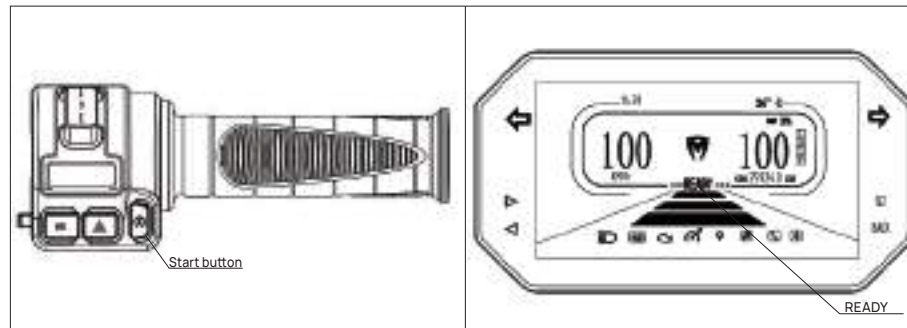

\* Before riding, please be fully aware the surrounding traffic and drive safe.

## Maintenance

---

Regular maintenance can improve the safety of the vehicle, as well as the service life. Please go to the authorized distributor or service provider for regular maintenance and inspection of the vehicle according to the following suggestions.

### 1. Cleaning

- ① Please make sure to turn off the air switch before cleaning;
- ② It is strictly prohibited to flush the vehicle directly with strong water stream. Otherwise, the electrical parts may be damaged or broken down;
- ③ Please clean the vehicle with clear water and neutral detergent. Use soft cloth to dry the vehicle after washing to prevent scratching; It is strictly forbidden to use sandpaper and metal brushes to clean the vehicle;
- ④ If the electrical system is accidentally affected during cleaning, please dry it with electrical dryer.

## Maintenance

---

### Regular Self-examination check list

No.	Inspection Interval	Inspection Item
01	1 month	Check whether the front and rear wheels are fastened.
02	Half a month	Check whether the brake calipers are fastened.
03	2 months	Check the level of brake oil.
04	3 months	Check the lubricating oil level of the gearbox
05	Half a month	Check brake pad status and the braking performance of brake system.
06	1 month	Check whether the handlebars are fastened.
07	1 month	Check the tightness of the chain/belt.
08	Half a month	Check the lubrication condition of the chain (make sure to cut off the power before lubricating and chain inspection).
09	Half a month	Check the belt cleanliness (make sure to cut off the power before cleaning and checking the belt)
10	1 month	Check whether the cable line is worn out or damaged.
11	1 week	Check whether the vehicle has abnormal sound or the sound caused by loose parts.
12	1 week	Check whether the tire pressure is 250kPa.

## Maintenance

### 3. Long-term Storage

- ① Storage status: turn off the air switch; disconnect the power supply circuit of battery, so as to prevent the over-discharge of the battery;
- ② Storage conditions: park the vehicle at dry and cool places, so as to protect it from being exposed to the strong sun light and rain. If the outdoor parking cannot be avoided, make sure to take out the battery, cover the vehicle with waterproof cover and mind the wind conditions.
- ③ In case long storage of the vehicle, please charge the battery fully before using, and check whether the tire pressure reaches the specified value. If the tire pressure is too low or too high, please restore the tire pressure to the specified value before using.

### 4. Maintenance Precautions

- ① The maintenance and repairing of parts and components needs to be performed by our after-sales service center, authorized service shops or distributors. Only the parts and components designated by the original factory can be used.
- ② The fault or part damage caused by the owner that fails to perform the regular maintenance according to Tromox's suggestions is not within the warranty scope;
- ③ Tromox can not be responsible for the results if the owner disassembles vehicle by himself/herself or uses the parts which are not officially approved by Tromox.

## Troubleshooting

Faults	Causes	Solutions	Faults	Causes	Solutions
The whole vehicle is powered off; the remote control and APP cannot be on.	Battery connection failed	Connect the battery plug correctly.	The battery cannot be charged.	The main charging plug subjected to poor contact	Check whether the main plug is correctly inserted.
	Battery management system(BMS) subjected to power-off protection	First, ensure there is no short circuit; after 10 minutes, turn on the power again		Wrong charger	Use the Tromox charger with designated model.
	Anti-theft alarm fault	Replace the anti-theft alarm.		Battery aging or normal scrap	Replace the battery.
	Fuse burned	Replace the main cable fuse.	There is metal scraping sound while braking	Brake pad is worn out	Replace the brake pad.
Air switch is not on	Turn on the air switch.	Brake disc loose		Tighten the bolts of brake disc.	
The motor doesn't run when the power is on, and the governor handlebar is turned.	Side stand is not folded	Fold the side stand.	The headlight and tail light cannot be switched on.	Control switch failure	Replace the switch.
	Battery is low	Charge the battery.		Plug loose or not inserted	Check the plug.
	Brake handle is not back to the correct position	Lubricate the brake handle joint and turn it to the correct position.		Power inverter failure	Replace the power inverter.
	Handlebar fault	Replace the handlebar.	Lamp holder burnt out	Replace the lamp.	
	Controller plug loose	Re-insert the controller plug.	The turn signal light doesn't work.	Power inverter failure	Replace the power inverter.
	Handlebar plug subjected to poor contact	Adjust the handlebar plug pins.		Control switch failure	Replace the switch.
	Motor Hall plug subjected to poor contact	Adjust the motor Hall plug pins.		Flasher failure	Replace the flasher.
Motor failure	Overhaul or replace the motor.	Lamp holder is burnt out		Replace the lamp.	
Controller failure	Replace the controller	The vehicle can be turned on, but the dashboard light is not on.	dashboard failure	Replace the dashboard.	
The riding speed is low or the riding range is relatively short	Battery is low		Charge the battery.	Power inverter failure	Replace the power inverter.
	Tire pressure insufficient	Remain the tire pressure at 225kPa.	There is no battery level, speed, time, temperature or other information displayed on the dashboard.	VCU communication module failure	Replace the VCU.
	Seriously overloaded	Avoid overloading		Anti-theft alarm communication module failure	Replace the Anti-theft alarm
	Brake pad interfering	Overhaul the brake caliper and adjust its installation position.	Controller communication module failure	Overhaul the controller communication module.	
The brake failure	Battery aged or normally scrapped	Replace the battery	Instrument communication module failure	Overhaul the instrument communication module.	
	Power inverter failure	Replace the power inverter			
	Brake handle switch damaged or subjected to open circuit	Replace the switch and inspect the circuit			

## After-sales Services

The user should correctly operate and use the vehicle according to the Owner's Manual. If a functional failure occurs due to product quality reasons, TROMOX will perform an unified repair, replacement, and return policy.

### After-sales Service and Limited Warranty

1.The Tromox after-sales service and limited warranty are implemented by distributors or authorized service shops. If there is any problem, please contact the after-sales service department or authorized distributors.

2.The list of after-sales service and limited warranty is as follows.

Part Name	Warranty Standard	Warranty Period
Power pack	After being charged fully under the specified service environment and used normally without the influence of external force, the lithium battery subjected to voltage abnormal, unable to be charged, temperature abnormal, or capacity less than 70% (the normal charging environment temperature is 0°-55°; the normal service environment temperature is -20°-70°; under the low-temperature condition, the capacity of lithium battery will decrease at different extent) is provided with a unified repair, replacement, and return policy. (The warranty period of the new lithium battery is calculated according to the remaining days of the warranty period of original purchased battery.)	3+21 months: provide the replacement service in the first 3 months and the repair or maintenance service in the latter 21 months.
Motor	Subjected to phase loss, demagnetization, parts or debris falling off, abnormal sound and other quality problems which cannot be repaired	24 months
Controller	Subjected to internal damage, no voltage regulation, no DC output and supply voltage too high	12 months
Converter	No DC output & supply voltage abnormal	12 months
Vehicle control unit (VCU)	The internal line or element is damaged, dashboard provides no data or incorrect data and the vehicle cannot be controlled through mobile phone App.	12 months
Remote key	a. The conventional functions of the remote control such as unlocking, fortifying, powering on, and powering off are invalid	12 months
Main cable	Be subjected to short circuit, open circuit, ablating or other irreparable faults	12 months
Headlight	Cannot work normally due to quality problem	12 months
Taillight	Cannot work normally due to quality problem	12 months
Turn signal light	Cannot work normally due to quality problem	12 months
License plate light	Cannot work normally due to quality problem	12 months

## After-sales Services

Part Name	Warranty Standard	Warranty Period
Charger	Cannot be charged normally; charging indicator light doesn't change	24 months
Horn	Cannot work normally due to quality problem	6 months
Lock	Out of order, subjected to functional failure	6 months
Dashboard	Incomplete display, no display or abnormal display	12 months
Brake system	a.The brake caliper is broken or seriously deformed; b.The brake oil leaks and cannot be repaired; c.Power is not off during brake and cannot be repaired.	6 months
Handle	The speed cannot be adjusted due to structure problem	6 months
Switch Assy	The switch is out of order, cannot be turned on or off to the proper position or cannot be reset; the part is broken or falls off due to quality problem; the internal part is subjected to short circuit, open circuit, poor contact or other failures.	6 months
Air switch	It doesn't automatically disconnect for protection in case of over-voltage or over-current, or cannot be normally used.	6 months
Handlebar	Handlebars at two sides have uneven height and inconsistent length and exceed the normal range; or, subjected to serious deformation, fracture or crack during normal operation.	12 months
Steering column	Subjected to serious deformation, insufficient welding, fracture or crack during normal operation	12 months
Rear fork	Subjected to fracture, crack, serious deformation or insufficient welding	12 months
Shock absorber	Subjected to oil leakage, insufficient welding, piston rod fractured or piston stuck during normal operation	12 months
Wheel rim	Subjected to fracture, crack or serious deformation during normal operation	12 months
Tire	Subjected to crack, bulge or breakage during normal operation	1 months
Vehicle frame	Subjected to serious deformation, insufficient welding, or cracking during normal operation; the license plate cannot be obtained due to the Frame code is not clear	36 months
Side stand	Subjected to fracture, insufficient welding, spring failure or falling off during normal operation	36 months
Seat cushion	Subjected to split sewing, cracking or serious deformation due to quality problem	6 months
Vehicle appearance & plastic parts	Surface subjected to peeling off due to coating problem; the parts can be replaced if the cracking area is bigger than 1cm <sup>2</sup> .	3 months

## After-sales Services

---

### Limited Warranty

- 1.The part has exceeded the specified warranty period and scope.
- 2.The product failure or damage is caused by artificial reasons, such as collision, crash, overload, excessive climbing and so on.
- 3.The product failure or damage which is caused by the user fails to correctly drive, maintain and adjust the product in accordance with the provisions in operation manual.
- 4.The test result shows that the bike is in normal condition.
- 5.The user doesn't use or maintain the battery properly which cause battery performance decline or technical failures. For example, the vehicle is left unused or parked for a long time or not charged in time, etc.
- 6.The use of charger or accessories which are not officially approved by Tromox, and results in the vehicle failure or performance problem.
- 7.The unauthorized part disassembling causes part failure and accessories damage.
- 8.Damage, malfunctions, or performance problems caused by aftermarket accessories installed on the vehicle which are not approved by Tromox.
- 9.The improper storage by user results in water logging, fire or chemical corrosion, thus causing failure and excessive consumptions.
- 10.The failure or damage is caused by force majeure (including but not limited to earthquake, typhoon, flood, fire, social events, mass incidents, violent crimes, and incidental losses of irresponsible traffic accidents).
- 11.The user alters, tears up or changes the warranty service date of product and components without authorization.
- 12.No valid warranty certificate can be provided; or, the invoice or voucher is inconsistent with product.
- 13.The product has no quality problem. The dissatisfaction with product riding feeling, appearance, color, sound level, sense of touch and other subjective reasons are not within the warranty scope.
- 14.The advertising/promotion products and gifts are not included in the warranty scope.
- 15.The brake pad is worn out.
- 16.The remote control of anti-theft alarm is lost.



At present, iOS and Android versions are available.  
Please check the operating system version of your smart phone before installation.

iOS system: | Android system:  
Support Apple iOS 9.0 and above | Support Android OS 5.0 and above

Get the Tromox Ukko app

Bind SN  
▼

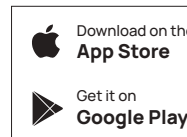

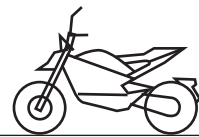

---

Welcome to join in Tromox family,  
let's have fun together!

---

[www.tromox.com](http://www.tromox.com)

# Electrical Schematic Diagram

